

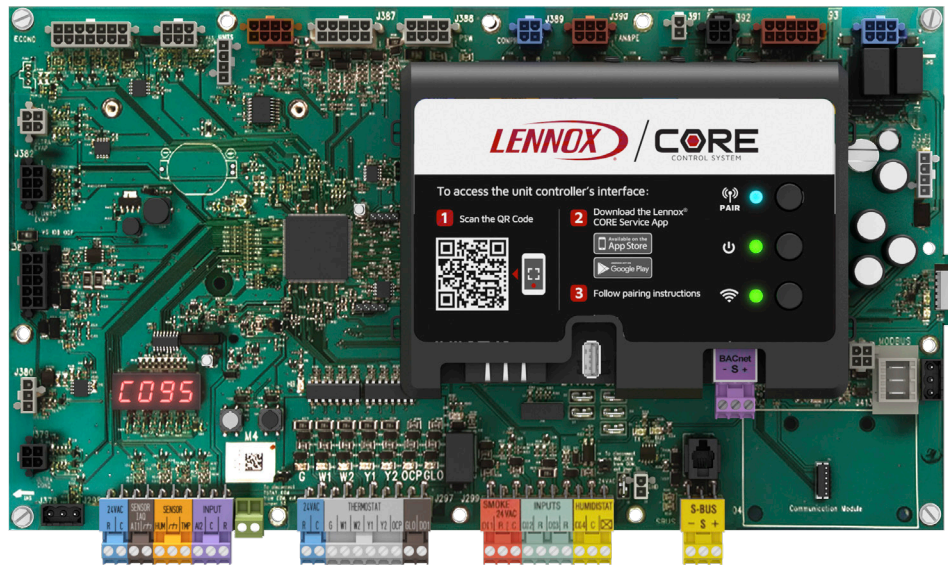


LENNOX® CORE CONTROL SYSTEM (UNIT CONTROLLER, LOW GWP) APPLICATION GUIDE

508685-01

05/2026

Supersedes 03/2026



⚠ WARNING



Electric Shock Hazard. Can cause injury or death. Unit must be properly grounded in accordance with national and local codes.

Line voltage is present at all components when unit is not in operation on units with single-pole contactors. Disconnect all remote electric power supplies before opening access panel. Unit may have multiple power supplies.

⚠ WARNING

Improper installation, adjustment, alteration, service or maintenance can cause property damage, personal injury or loss of life. Installation and service must be performed by a licensed professional HVAC installer or equivalent, service agency, or the gas supplier.

⚠ WARNING

To prevent serious injury or death:

1. Lock-out/tag-out before performing maintenance.
2. If system power is required (e.g., smoke detector maintenance), disable power to blower, remove fan belt where applicable, and ensure all controllers and thermostats are set to the "OFF" position before performing maintenance.
3. Always keep hands, hair, clothing, jewelry and tools away from moving parts.



05/26

508685-01

Table of Contents

1. Abbreviations and Terms.....	5	6. Main Controller Operations	31
2. Unit Controller Description.....	6	6.1. Control Type - Thermostat.....	31
2.1. M4 Unit Controller Layout and Connections	6	6.1.1. Cooling Stages.....	31
2.1.1. CORE Unit Controller Overview.....	6	6.1.2. Heating Stages.....	34
2.1.2. Lennox® CORE Service App.....	8	6.2. System Mode - Room Sensor	38
2.2. Lennox CORE Unit Controller - Connections, Inputs /		6.3. Room Sensor Primary Modes:.....	38
Outputs, Jumpers, and LEDs Locations.....	8	6.3.1. Room Sensor Back-up Modes.....	38
2.2.1. Thermostat Common Isolation - TSTAT_COM Jumper.....	8	6.3.2. Room Sensor Back-Up Mode Set Points.....	38
2.2.2. Humidistat Common Isolation - HMD_COM Jumper	8	6.3.3. L Connection Network Back-Up Mode.....	39
2.2.3. W4 Control - USB Flash Drive Interface Usage ...	8	6.3.4. Heating and Cooling Stages in Room Sensor Mode	39
2.2.4. S-BUS (Smartwire™) (J304).....	8		
2.2.5. MODBUS Connections	8	7. Lennox® Low GWP Refrigerant Detection System	42
2.2.6. CORE Unit Controller LED Indicators	9	(RDS).....	42
2.2.7. Local Interface - Push Buttons and Heart Beat.....	9	7.1. Sensors	42
2.2.8. Local Interface - Four Character Seven-Segment		7.2. Alarms	42
LED - Status Codes	9	7.3. Mitigation Actions	42
2.2.9. Auto-Addressing.....	10	7.3.1. Actions on a Refrigerant Leak.....	42
3. Communication Module - Connections, Buttons, and	11	7.3.2. Actions on a Faulty or Missing Sensor.....	42
LEDs	11	7.4. User Test.....	42
3.1. Buttons and LED Indicators.....	11	7.5. Sensor Placement	43
3.1.1. Pairing Button and LED.....	11	8. Unit Component Operation - Protection, Delays, and	43
3.1.2. Reset Button and Heart Beat LED.....	11	Switches	43
3.1.3. Cloud / IP Button and LED Indicators	11	8.1. Compressor Protection and Delays.....	43
3.2. BLE Wireless Gateway	11	8.1.1. Compressor Minimum Run-Time Off-Delay.....	43
3.3. CORE Service App.....	11	8.1.2. Freezestat	43
3.4. Cloud Firmware Updates.....	11	8.1.3. Thermal Protection Switches	43
4. Updating M4 Firmware.....	12	8.1.4. High Pressure Switches	44
4.1. Confirming Current M4 Unit Controller Firmware Version...	12	8.1.5. Low Pressure Switches	
4.2. Preparing USB Flash Drive	12	(S87, S88, S97, and S98)	44
4.3. Files Needed for Update	12	8.1.6. Loss-of-Power Detection	44
4.4. Creating Folder.....	12	8.1.7. Compressor Speed Foldback.....	44
4.5. Updating Firmware.....	12	8.2. Gas Units Burner Protection and Delays	44
5. CORE Service App - Unit Operations	14	8.2.1. Primary or Secondary Limits (S10 and S99)	44
5.1. CORE Service App Menu Selection Overview	14	8.2.2. Flame Roll-Out Switches (S47 and S69)	44
5.2. Pairing CORE Service App to CORE Unit Controller	14	8.2.3. Combustion Air Inducer (CAI) Proof Switches (S18	
5.3. System Overview - Room Sensor Mode	14	and S45)	45
5.4. Active Alarms.....	15	8.2.4. Gas Valve Sensor Activation Feedback.....	45
5.5. CORE Service App General Menu + User Preference.....	15	8.2.5. Gas Heat Valve Delays	45
5.6. CORE Service App RTU Menu	15	8.3. Miscellaneous Components	45
5.6.1. Setup.....	15	8.3.1. Thermostat Bounce Delay (Wired Thermostat Mode	
5.6.2. Install Menu Navigation.....	17	Only)	45
5.6.3. Network Integration.....	18	8.3.2. Return Air Temperature Limits	45
5.6.4. Test and Balance	22	8.3.3. Safety Switch Input (A42-Optional)	46
5.7. Data.....	25	8.3.4. Air Flow Proving Switch (S52 - Optional)	46
5.7.1. Alarm History.....	25	8.3.5. Dirty Filter Switch (S27 - Optional)	46
5.7.2. Data Trending.....	25	8.3.6. Overflow Switches (S149 / S179 - Optional)	46
5.7.3. Factory	25	8.3.7. Blower On-Delay	46
5.7.4. Runtimes.....	25	8.3.8. Blower Off-Delay	47
5.7.5. System Data / Sensor Data / Output.....	26	8.3.9. Unoccupied or Night Setback Mode	47
5.8. Service	26	8.3.10. Gas and Electric Heat Warm-Up Mode (During	
5.8.1. Component Test.....	26	Occupied Time Period)	47
5.8.2. Report	28	8.3.11. Cool-Down Delay (During Occupied Time Period) 47	
5.8.3. Advanced Control.....	28	8.4. Gas Heat Operation — Gas Units	47
5.9. Settings	29	8.4.1. Heat Speeds	47
5.9.1. RTU Options	29	8.5. Electric Heat Operation	48
5.9.2. Install.....	30	8.5.1. Electric Heat Stage Delay Operation	48
		8.5.2. Primary or Secondary Limits	48
		8.6. Mechanical Heat Operation.....	48
		8.6.1. Enhanced HP Heating Efficiency – 2-Ton LH/LD	
		Units.....	48

8.7. Defrost Operation	48	12.3. How to Enable or Disable Enhanced Dehumidification Mode.....	73
8.8. Reversing Valve Operation.....	49	13. Power Exhaust Operations.....	73
9. Sensors	50	13.1. Enabling Feature.....	73
9.1. Temperature Sensors	50	13.2. Control.....	73
9.2. Room Sensor - Optional.....	50	13.3. Operation Based on Various Options	73
9.3. Relative Humidity Sensor - Optional	50	14. Economizer Operations	74
9.4. Carbon Dioxide (Indoor Air Quality) Sensor - Optional.....	51	14.1. General	74
9.5. Supply Static Pressure Sensor - Optional.....	51	14.2. Enabling Economizer and Settings	74
9.6. Enthalpy Sensor - Optional	51	14.3. Damper Feedback Calibration and Minimum Damper Position.....	74
9.7. Sensors (Strategos Heat Pump Units Only).....	51	14.4. Damper Operation During Free Cooling	74
9.7.1. High Pressure Transducer (PT7, PT10).....	51	14.5. Free Cooling Compressor Lockout Mode and Low Ambient Set Point.....	74
9.7.2. Low Pressure Transducer (PT8, PT11).....	51	14.6. Outdoor Air Suitable for Free Cooling	74
9.7.3. Liquid Pressure Transducer (PT9, PT12).....	51	14.7. Enthalpy Set Point	75
9.7.4. Discharge Line Thermistor (RT66, RT67).....	51	14.8. Free Cooling Damper Maximum Position	75
10. Outdoor Fan Operations during Various Ambient Conditions.....	52	14.9. Motorized Outdoor Air Damper	75
10.1. High Ambient Conditions - LCM/LGM B and C Box; Enlight A, B, C Box (7-1/2 to 25-ton); Strategos A Box	52	14.10. Economizer Checkout	75
10.2. Normal Ambient Conditions.....	52	15. Demand Control Ventilation (DCV) Operations	77
10.3. Low Ambient Conditions	52	15.1. General	77
10.4. Compressor / Fan Key	52	15.2. Default Operation	77
10.5. Compressor / Fan Configurations	53	15.3. Maximum and Minimum Demand Control Ventilation Damper Settings.....	77
10.6. Low Ambient Outdoor Fan Control and Cycling	56	15.4. Parameter Adjustments	77
10.6.1. A Box LCM/LGM 036U, 048U, 060U and 074U..	56	15.4.1. Set Point Control Option	78
10.6.2. B Box LCM/LGM 092U, 102U, 120U and 150U .	56	15.4.2. Determining Indoor Air Quality Inputs	78
10.6.3. C2 Box LCM/LGM 156U and 180U.....	57	16. Outdoor Air Control (OAC) Operations	79
10.6.4. C3 Box LCM/LGM 210U, 240U and 300U	58	17. Building Pressure Control (BPC) Operations	81
10.6.5. A Box LGT, LCT 036H, 048H, 060H and 072H...	59	18. Supply Air Delivery Operations.....	81
10.6.6. B Box LGT, LCT 092H, 102H, 120H and 150H...	59	18.1. Blower Delays	81
10.6.7. C1 Box LGT, LCT 156H	60	18.1.1. Gas Heat Operation	81
10.6.8. C2 Box LGT, LCT 180H	61	18.1.2. Electric Heat Operation	81
10.6.9. C2 Box LGT, LCT 210H	62	18.1.3. HP Operation	81
10.6.10. C3 Box LGT, LCT 240H, 300S, and 300H	63	18.1.4. Cooling Operation	81
10.6.11. D Box LGT, LCT 302H, 360H	64	18.2. Supply Multi-Stage Air Volume (MSAV) Control Mode	81
10.6.12. D Box LGT, LCT 302H, 360H	65	18.3. Supply Variable Air Volume (VAV) Control Mode	81
10.6.13. D Box LGT, LCT 302H and 360H.....	66	18.4. Variable Frequency Drive (VFD) Control.....	82
10.6.14. A Box LHT, LDT 024H, 036H, 048H, 060H, 072H.....	67	19. Analog Output Control Operations.....	82
10.6.15. B Box LHT, LDT 078H, 092H, 102H, 120H.....	67	19.1. Supply Manual Reset — Parameter 41	82
10.6.16. B2 Box LHT, LDT 122H and 150H.....	68	19.2. Supply Proportional Constant (P) — Parameter 31	82
10.6.17. B3 Box LHT, LDT 120H and 152H.....	68	19.3. Supply Integral Constant (I) — Parameter 32	82
10.6.18. C3 Box LHT, LDT 156H, 180H and 240H	69	19.4. Supply Derivative Constant (D) — Parameter 33	82
10.6.19. D Box LHT, LDT 302H, 360H.....	70	19.5. Parameter Adjustments and Tuning Method	82
11. Dehumidification Operations	70	19.6. Indoor Blower Auto Calibration (3 - 12.5 Ton Units Only)	83
11.1. Humiditrol+ Dehumidification Operation — (Humiditrol Reheat).....	70	19.7. Supply Airflow Measurement and Control	83
11.1.1. Option 0 — No Reheat.....	71	20. Discharge Air Control Operations	84
11.1.2. Option 3 — Humiditrol+ Reheat Operation	71	20.1. Cooling	84
11.1.3. Option 4 — Relative Humidity Measurement.....	71	20.1.1. Discharge Air Control Cooling (DACC) Outdoor Air Temperature (OAT) Reset.....	84
11.1.4. Option 5 — Humiditrol+ Reheat Operation	71	20.1.2. Discharge Air Control Cooling (DACC) Return Air Temperature (RAT) Reset	84
11.1.5. Option 6 — Humiditrol+ Reheat Operation	71	20.1.3. Discharge Air Control Cooling (DACC) Total Reset Limit	85
11.1.6. Option 7 — Humiditrol+ Reheat	71	20.2. Heating	85
11.1.7. Option 8 — Humiditrol+ reheat	71	20.2.1. Discharge Air Control Heating (DACH) Outdoor Air Temperature Reset	85
11.2. Third Party Digital Input to Control Dehumidification	71	20.2.2. Discharge Air Control Heating (DACH) Return Air Temperature Reset	86
11.2.1. Method 1	71	20.2.3. Discharge Air Control Heating (DACH) Total Reset Limit	86
11.2.2. Method 2	71	12. Enhanced Dehumidification Operations	72
12. Enhanced Dehumidification Operations	72	12.1. Dehumidification in Wired Thermostat Mode	72
12.1. Dehumidification in Wired Thermostat Mode	72	12.2. Enhanced Dehumidification in Room Sensor Mode.....	72
12.2. Enhanced Dehumidification in Room Sensor Mode.....	72	12.2.1. Enhanced Dehumidification without a Cooling Demand	72
12.2.1. Enhanced Dehumidification without a Cooling Demand	72	12.2.2. Enhanced Dehumidification with a Cooling Demand.....	72
12.2.2. Enhanced Dehumidification with a Cooling Demand.....	72		

21. Third-Party Zoning Operations	87
21.1. Air Delivery Operation	87
21.2. Occupied /Unoccupied Operation	87
21.3. Cooling Operation	87
21.3.1. Discharge Air Control Cooling Outdoor Air Reset	87
21.3.2. Discharge Air Control Cooling Return Air Reset	87
21.4. Heating Operation	87
21.4.1. Discharge Air Control Heating Outdoor Air Reset	87
21.4.2. Discharge Air Control Heating Return Air Reset	87
21.5. Power Exhaust Operation	87
21.6. Supply Bypass Damper Control	88
22. Load Shedding Options	88
23. Service Relay Operations	89
23.1. System Relative Humidity Options	89
23.2. System Indoor Air Quality / Carbon Dioxide Options	89
23.3. System Outdoor Air Temperature Operation	90
24. Sequence of Operations	92
24.1. Unit Controller Control Modes	92
24.1.1. Unit Controller In Room Sensor Mode	92
24.1.2. Unit Controller In Thermostat Mode	92
24.1.3. Operations Common to All Rooftop Units	93
24.1.4. CAV Units in Single-Zone Applications with a Lennox Room Sensor	94
24.1.5. CAV Units in Single-Zone Applications — Wired Thermostat or Third-Party Unit Controller	95
24.1.6. Discharge Air Control (4-Heat / 4-Cool)	96
24.1.7. Bypass Zoning Applications (2-Heat / 2-Cool)	97
24.1.8. Bypass Zoning Applications (4-Heat / 4-Cool)	97
25. Unit Operations Summary	99
25.1.1. Unit Operations - Model L	99
25.1.2. Unit Operations - Strategos HP	101
25.1.3. Unit Operations - Enlight/Strategos	105
26. CORE Control System - Alarms	125
26.1. Phase - Voltage Detection	125
26.2. Service Relay Contacts DO1	125
26.3. Alarm and Event Codes	126
27. CORE Control System - Parameters	140
28. CORE Firmware Update Release History	159

1. Abbreviations and Terms

Table 1. Abbreviations and Terms

Abbrev	Definition
A55	M4 board. Main RTU control board
AI	Analog input
AO	Analog output
B4	Motor, Outdoor Fan 1
B5	Motor, Outdoor Fan 2
B21	Motor, Outdoor Fan 3
B22	Motor, Outdoor Fan 4
B23	Motor, Outdoor Fan 5
B24	Motor, Outdoor Fan 6
B1	Compressor 1
B2	Compressor 2
B13	Compressor 3
B20	Compressor 4
BL	Blower
C4	Add on board for the third and fourth heating stages and third and fourth compressor and associated fans.
C1	1st stage cooling
C2	2nd stage cooling
C3	3rd stage cooling
C4	4th stage cooling
CAI	Combustion air inducer
CAVB	Constant air volume with bypass damper
COM	Electrical common
CL	Cooling
CSP	Cooling setpoint
DAC	Discharge (supply) air control
DACC	Discharge (supply) air control cooling
DACH	Discharge (supply) air control heating
DAP	Discharge (supply) air pressure
DAT	Discharge (supply) air temperature
DCV	Demand controlled ventilation
DDC	Direct digital control
DI	Digital input
Diff	Differential
DO	Digital output
FAC	Fresh air cooling control
FAH	Fresh air heating control
FAT	Fresh air tempering control. See FAC & FAH
FC	Free cooling
G	Thermostat demand, blower
GLO	Global mode or input (economizer)
GWP	Global Warming Potential
H1	1st stage heating
H2	2nd stage heating
H3	3rd stage heating
H4	4th stage heating
HP	High pressure
HSP	Heating setpoint
HT	Heating
IAQ	Indoor air quality. Often synonymous with CO ₂ level in ppm.
IDE	Indoor enthalpy. Depends on temperature and humidity.
LAH	Low Ambient Heating

Table 1. Abbreviations and Terms

Abbrev	Definition
LED	Light emitting diode. An indicator light, found either as individual elements or grouped together as segments to form characters
LP	Low pressure
LT	Limit
M4	M4 unit controller - main controller board (A55)
MGV	Modulating gas valve
MSAV	Multi Stage Air Volume
OAC	Outdoor air control
OAS	Outdoor air suitable for free cooling
OAT	Outdoor air temperature
OCP	Thermostat demand, occupied mode
ODE	Outdoor enthalpy. Depends on temperature and humidity.
PID	Proportional, integral and derivative based control loop
PPM	Parts per million (mostly used for CO ₂ measurements)
PWM	Pulse Width Modulation
RAP	Return air pressure
RAT	Return air temperature
RDS	Refrigerant Detection System
RH	Relative humidity
RS	Reset
RTU	Roof top unit
RT6	Discharge air temperature sensor
RT16	Return air temperature sensor
RT17	Outdoor air temperature sensor
SMK	Smoke detection mode (alarm)
SP	Setpoint
Stg	Stage
TB	Terminal block
UnOCP	Unoccupied
VAC	Alternating current voltage
VAV	Variable Air Volume - This function is accomplished with a variable frequency drive (VFD) in C Boxes, and an electronically commutated motor (ECM) direct drive blower in A and B Boxes.
VDC	Direct current voltage
VFD	Variable frequency drive. An AC inverter used to vary motor speed.
VT	Ventilation
w.c.	Inches of water column
W1	Thermostat demand, heat stage 1
W2	Thermostat demand, heat stage 2
W3	Thermostat demand, heat stage 3
W4	Thermostat demand, heat stage 4
Y1	Thermostat demand, cooling stage one
Y2	Thermostat demand, cooling stage two
Y3	Thermostat demand, cooling stage three
Y4	Thermostat demand, cooling stage four
ZAT	Zone air temperature

2.1.1.1. Configurable Sequences of Operation

- Single-Zone VAV (Discharge Control) Cooling with room sensor, DDC, or thermostat
- Three cooling stages (with compatible thermostat or DDC)
- Four heating stages using a room sensor (up to two with thermostat / DDC Controls)
- Four heating stages in VAV/Discharge Air Control with thermostat input to W1
- Multi-Zone VAV (Discharge Control) Heating and Cooling
- Economizer Control Options (See Economizer / Exhaust Air / Outdoor Air sections)
- Exhaust Fan Control Modes for fresh air damper position
- Configurable morning warm-up and morning cool-down
- Night Setback Mode
- Fresh Air Tempering for improved space temperature control during ventilation
- Demand Control Ventilation
- Low Ambient Controls for operation down to 0°F
- Humiditrol™ + Operation (Variable Capacity Hot-Gas Reheat)
- Enhanced Dehumidification (Latent Demand Control without reheat)

2.1.1.2. Component Protection / Unit Safeguards

- Compressor Time-Off Delay
- Adjustable Blower On/Off Delay
- Return Air Temperature Limit Control
- Safety Switch Input allows Controller to respond to an external safety switch trip
- Service Relay Output
- Thermostat Bounce Delay
- Smoke Alarm Mode has four choices (unit off, positive pressure, negative pressure, purge)
- “Strike Three” Protection
- Gas Valve Time Delay Between First and Second Stage
- Minimum Compressor Run Time
- Low GWP Refrigerant Detection System
- Compressor Map Protection
- Inverter Ampacity Limit Control
- Low and High Pressure Foldback Control

2.1.1.3. Control Methods / Interfaces

- DDC and 24V Thermostat
- BACnet (MS/TP) and IP
- LONTalk (Factory & Field Option)
- Lennox S-BUS
- Zone Temperature Sensor Input

2.1.1.4. Additional Features

- Dehumidistat and Humidity Sensor Inputs
- Air Quality Inputs (2). One IAQ Input is for report only.
- Built-in Control Parameter Defaults
- Diagnostic Code Storage
- Field Adjustable Control Parameters (Over 200 settings)
- Dirty Filter Switch Input
- Condensate Overflow
- Phase Detection
- Load Shed
- Remote Shutdown Inputs

2.1.1.5. Network Types Supported

The following are the types of communication network types supported.

Table 3. Network Types

Screen Label	Network Type
LON	LonTalk (Required Optional LON Module)
BACNET	BACnet MS/TP and IP
LCONN	L-Connection

2.1.2. Lennox® CORE Service App

The Lennox® CORE Controller allows setup and configuration with other items through the use of a free Lennox-supported smartphone app (Android and iOS devices supported) and a Bluetooth connection.

2.1.2.1. Android or iOS Device Minimum System Requirements

- Android hardware requires 2GB RAM and 2GHz Core processor. Tablets are supported.
- The service application is available for both iOS 11.0 or higher (App Store) and Android 9.0 or higher (Google Play).
- Scan the applicable QR code below to download the CORE Service App to your mobile device.



2.1.2.2. App Connectivity

- Setup menu ensures proper installation and simplified setup of the rooftop unit
- Detailed data readout updates sensor values in real time and allows trending
- Unit self-test verifies individual critical component and system performance
- Economizer test function ensures economizer is operating correctly

2.2. Lennox CORE Unit Controller - Connections, Inputs / Outputs, Jumpers, and LEDs Locations

2.2.1. Thermostat Common Isolation - TSTAT_COM Jumper

Thermostat (TSTAT) sensor commons are located on connector J298 and may be isolated if they are powered remotely. Cut jumper.

This jumper is located to the left of J297 connector. This jumper would be removed only in unique situations where the device supplying the thermostat signals to the CORE unit controller has its own power source and does not share a common reference voltage with the CORE unit controller. Otherwise the jumper would remain installed across both pins, as shipped from the factory.

2.2.2. Humidistat Common Isolation - HMD_COM Jumper

The humidity (HUM) sensor commons are located on connector J299 and may be isolated if they are powered remotely.

Cut jumper. This jumper is located to the right of J299 connector. This jumper would be removed only in unique situations where the device supplying the thermostat/humidistat signals to the CORE unit controller has its own power source and does not share a common reference voltage with the CORE unit controller. Otherwise the jumper would remain installed across both pins, as shipped from the factory.

2.2.3. W4 Control - USB Flash Drive Interface Usage

The W4 Control uses a USB type A interface. This USB port is used for downloading reports, transferring unit profiles and performing firmware updates.

On-site data collection requires use of either a USB flash drive or download and shared from the CORE Service App. Data written to the drive include date, time, serial number, catalog number, basic data, error code buffer, and unit configuration.

2.2.4. S-BUS (Smartwire™) (J304)

This is the L-connection interface which is an RS-485 network connection with other devices (NCP, comfort sensors, other RTU, etc.).

2.2.5. MODBUS Connections

This is a TIA-485 serial line over MODBUS (messaging structure) communication. This connection is used for multiple components.

2.2.5.1. MODBUS Connection (J413)

Used for blower and DSI connection. The white J413 connector is used to connect the MODBUS signal to the UTEC DSI board #1 and #2. It has three pins connected to P10 and J358.

2.2.5.2. MODBUS Connection (J358)

J358 is a four-pin white connector for connecting compressor inverter MODBUS cable.

2.2.5.3. MODBUS Connection (P10)

Not used at this time.

2.2.6. CORE Unit Controller LED Indicators

Table 4. LED Operation Indicators

LED	Status	Indication	Meaning
Heartbeat (HB) (D33)	Green	Slow Flash	Normal Operation
	Green	Fast Flash	Boot loader / firmware update mode
	No light	Steady Off	No voltage to M4 board or defective board
	Green	Steady On	Unit in configuration / test mode (not in normal mode)
S-BUS / PC Connection (D70 and D71)	BUS (green)	Flickering ON	Network traffic present
	TX (Yellow)	Flickering ON	Unit controller is transmitting
Thermostat Input	Yellow	Indicates a thermostat demand	G - Blower on
			W1 - First-Stage Heating
			W2 - Second-Stage Heating
			Y1 - First-Stage Cooling
			Y2 - Second-Stage Cooling
			OCP - Occupied
MODBUS	Two LEDs that indicate transmit (TX) and receive (RX) activity.		
	<p>Slow Flash = 1 second on; 1 second off.</p> <p>Fast Flash = ½ second on; ½ second off.</p> <p>A "flickering" LED flashes significantly faster than a "fast flash".</p> <p>NOTE: LEDs are energized by 24VAC thermostat inputs.</p>		

2.2.7. Local Interface - Push Buttons and Heart Beat

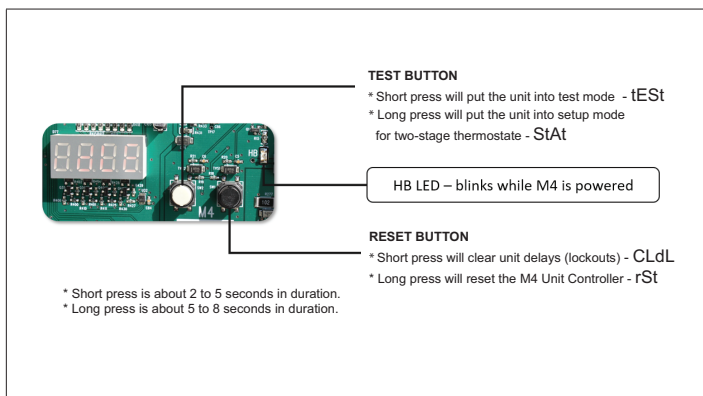


Figure 2. Push Buttons and Heart Beat

Table 5. M4 Push Button Codes

Code	Cause	Action
CLdL	Black Button: Short Press	Clear Delays
rSt	Black Button: Long Press	Reset
tEst	White Button: Short Press	TSTAT Test
StAt	White Button: Long Press (In Pre-Install state)	TSTAT Override
tEst	White Button: Long Press (NOT in Pre-Install state)	TSTAT Test
Short Press : 2 to 5 seconds. Long Press : 5 to 8 seconds.		

2.2.8. Local Interface - Four Character Seven-Segment LED - Status Codes

The "X" in some of the codes represent the percent demand.

Table 6. Status Codes

Status Code	Definition	Priority	Notes
boot	Booting	0	Appears on display throughout the boot sequence
FFt	FFT Test	1	Appears when in FFT Test (not for mobile app)
PnSt	PreInstall	2	
tEst	Testing In Progress	3	Appears on display throughout any test execution
A173	Smoke	4	
LoUt	Controller Lockout	5	
LEAK	Refrigerant leak detected	6	
Eror	Off On Alarm	7	
d300	Delay up to 5 min	8	
d020	Delay up to 20 seconds	9	
dhUM	Dehumidification	10	
ShEd	Compressor Load Shedding	11	
Prht	Morning Warm-up	12	
Strt	Start Up	13	
FdhU	Fresh Air Reheat	14	
FAh	Fresh Air Heating	15	
dC12	Defrost Compressor 1 & 2	16	Simultaneous defrost not supported. For future use.
dC1	Defrost Compressor 1	17	
dC2	Defrost Compressor 2	18	
EMht	Emergency Heating	19	
MXht	MAX Heating	20	
hXXX	Heating	21	
PrCL	Pre-Cool	22	
CEoP	Cool + Max Open Economizer	23	

Table 6. Status Codes

Status Code	Definition	Priority	Notes
CEXX	Cool + Modulate Economizer	24	100% displays as CE00
FrCL	Free Cooling	25	
FAC	Fresh Air Cooling	26	
CXXX	Cooling	27	
bXXS	Blower On - OAS	28	100% displays as b00S
bXX	Blower On	29	100% displays as b00
ioAS	No Demand - OAS	30	
idLE	No Demand	31	

2.2.9. Auto-Addressing

The CORE controller has the ability to automatically configure the MODBUS addresses of certain components as needed (e.g. when a blower or compressor is replaced in the field).

Auto-addressing is an automatic process that runs every time the unit powers up. It configures the MODBUS communication addresses for blowers and compressors, regardless of their physical installation location. Devices can be replaced without pre-programming—the Core controller board automatically detects and assigns the correct addresses.

Auto-addressing occurs on units equipped with:

- Twin EBM Blowers (two blowers)
- Two Copeland variable-speed compressors

During each power-up, the system verifies the current device addresses and re-assigns them if needed. Contactors will engage/disengage with multiple clicking sounds as devices are individually powered on and off.

Time Duration:

- 15-30 seconds (if all devices are already configured correctly)
- 1-5 minutes (if one or more devices require reprogramming)

The system verifies each device at its expected address, then powers down and reassigns addresses only if necessary.

NOTE:

- Do not power off the unit during auto-addressing - allow the process to complete uninterrupted
- Contactor cycling is normal during this process, it is not a fault condition
- Units with single blower and single compressor configurations use default addresses and do not require auto-addressing.

3. Communication Module - Connections, Buttons, and LEDs

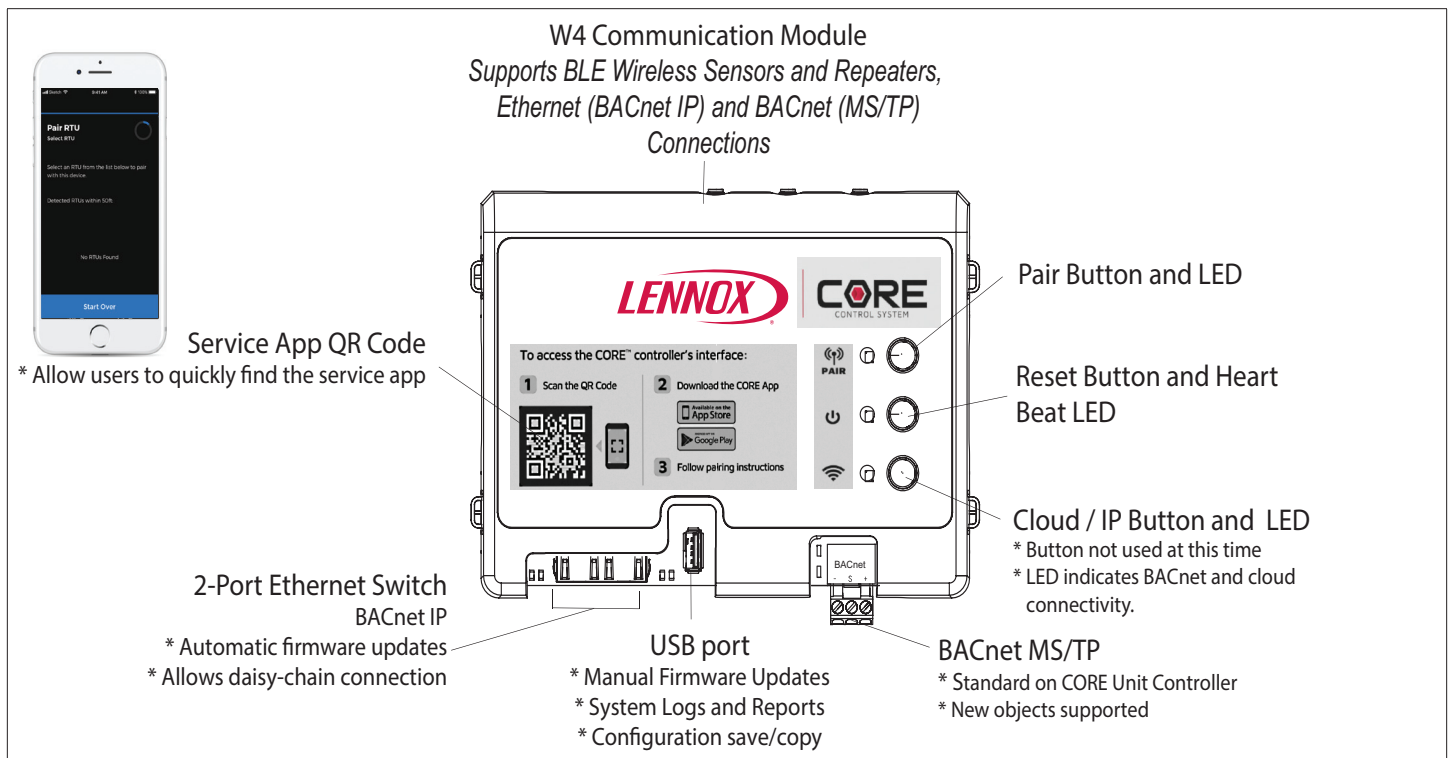


Figure 3. W4 Controller Interfaces

3.1. Buttons and LED Indicators

3.1.1. Pairing Button and LED

- Press this button for five (5) seconds to enable pairing to the application.
- LED status indicators are:
 - > **Solid blue** indicates either BLE is booting up or application is already connected.
 - > **Green** indicates ready for connection.
 - > **Blinking blue** indicates in pairing mode.

3.1.2. Reset Button and Heart Beat LED

- Press the reset button for two to eight seconds to reboot the W4 communication module.
- Blinking LED indicates W4 communication module has power.

3.1.3. Cloud / IP Button and LED Indicators

- Button is currently not available for use.
- LED indicators are:
 - > **Steady Green** indicates Ethernet is connected to the cloud and active.
 - > **Steady Amber** indicates Ethernet is connected the cloud but not active.
 - > **Steady Red** indicates Ethernet is connected but with no connection to the cloud (i.e. BACnet IP).

- > **Blinking Green** indicates firmware update is in progress.
- > **Steady Purple** indicates log data is downloading to a USB drive.

3.2. BLE Wireless Gateway

Provides the following:

- Plenum-rated BLE antenna
- Factory installed placement allows for use in vertical and horizontal applications
- Coax cable connects gateway to W4 control
- Return air duct mount enables a boosted signal from CORE unit controller to CORE Service App mobile device

3.3. CORE Service App

- Reduces installation setup and service times
- Simple component test
- Connects to the CORE unit controller via the W4 Communication Module BLE gateway
- Pairs with a simple button press (requires physical access)
- Used for install, service, and maintenance of applicable Lennox commercial systems

3.4. Cloud Firmware Updates

- Internet connection is required
- Can be set to on-demand or automatic. Default setting is set to on-demand.

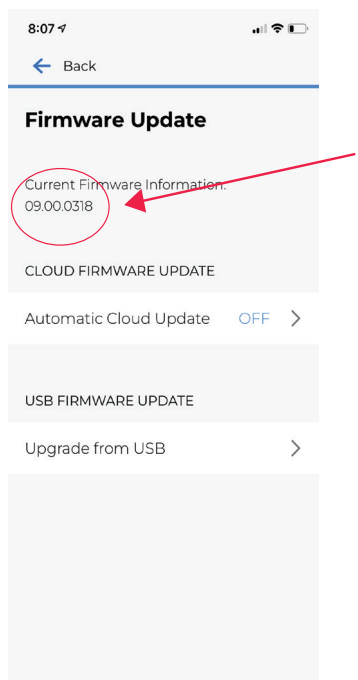
- Updates only available when CORE unit controller is connected to cloud via IP (Ethernet)
- Check firmware on-demand or set it nightly. Either method can be configured using the CORE Service Application. Updates are also available via USB interface on the CORE unit controller.

4. Updating M4 Firmware

Firmware updating is available using the M4 unit controller USB port. Use the following procedures to update the M4 Unit controller firmware.

4.1. Confirming Current M4 Unit Controller Firmware Version

Use the CORE Service app to navigate to **MENU > RTU MENU > SERVICE > FIRMWARE UPDATE**. The installed firmware version displays at the top of the screen.



Scan the QR code. The QR code directs you to the current M4 firmware version found at <https://www.lennox.com/commercial>.



4.2. Preparing USB Flash Drive

Use the FAT32 file system to format the USB flash drive media. A 32GB capacity USB flash drive is recommended.

4.3. Files Needed for Update

COREXXXXXXXXX.C1F is required to upgrade the M4 unit controller from the USB flash drive.

NOTE: All CAPS is recommended, but not mandatory.

NOTE: The xxxxxxxx are place holders for major and minor versions and build number information in the actual file name and varies from one version to the next.

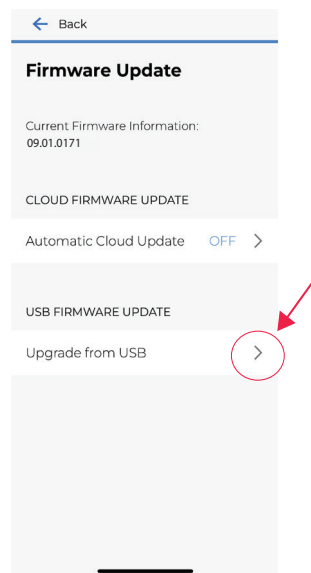
4.4. Creating Folder

- Step 1.** Create a folder on the root of the USB flash drive called "Firmware".
- Step 2.** Create a sub-folder under the "Firmware" folder called "M4."
- Step 3.** Place a copy of the COREXXXXXXXXX.C1F file into the sub-folder labeled "M4".

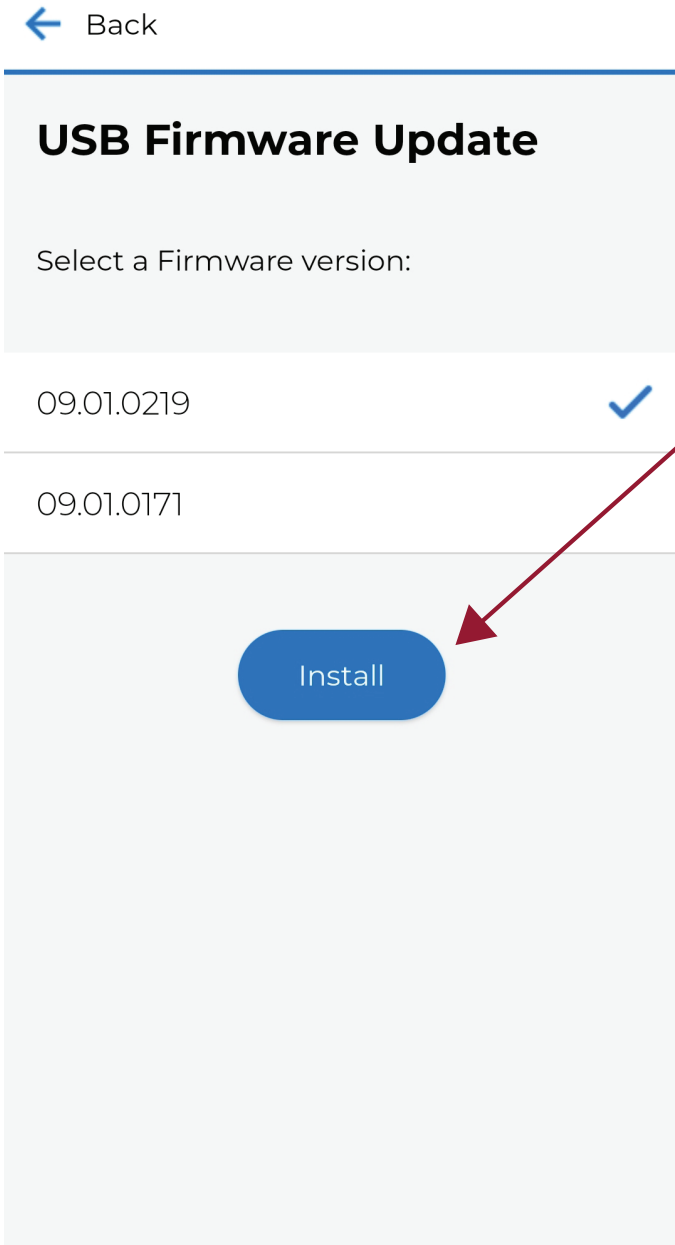
4.5. Updating Firmware

The firmware can be updated via the CORE Service app:

- Step 1.** Insert the USB flash drive into the CORE unit controller USB port.
- Step 2.** Navigate to **MENU > RTU MENU > SERVICE > FIRMWARE UPDATE** and select **Upgrade from USB**.



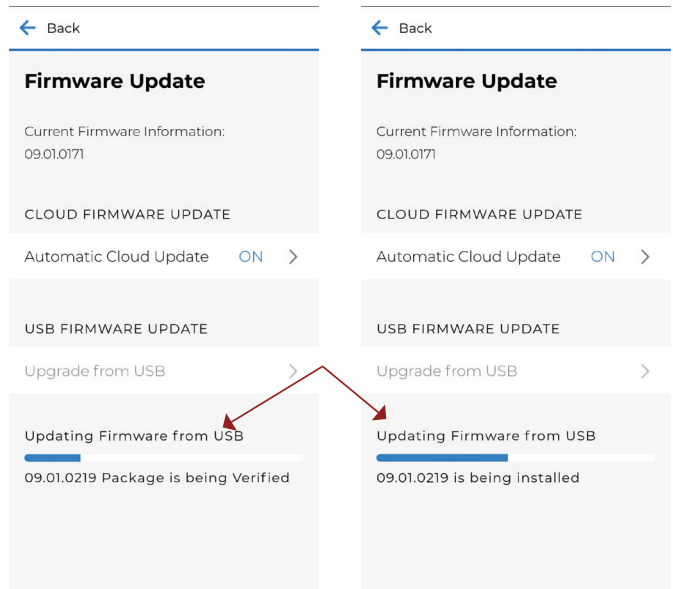
The firmware version on the USB flash drive displays on the next screen.



Step 3. Select **Install** to proceed.

NOTE: A firmware upgrade lasts for 10 to 15 minutes.

The next screen displays the firmware update status.



After the firmware update completes, a confirmation screen displays, which indicates the update is complete. The system will reboot.

Step 4. Repeat steps 1 and 2 to verify the firmware is updated after the unit controller reboots and the CORE Service App reconnects.

NOTE: Firmware information is also listed on the unit controller's seven segment display during boot-up. The firmware is listed in the following order:

- Major
- Minor
- Build

NOTE: Firmware updates do not alter the unit controller configuration settings. All settings are retained after the firmware update.

5. CORE Service App - Unit Operations

This section describes the display and control buttons, how to configure the unit, and how to read stored configuration data, status, and alarms.

- The CORE unit controller is an input and output junction point.
- If in the thermostat mode, thermostat inputs at P297 result in an output to unit components.
- If the heartbeat LED is not flashing, see “Table 4. LED Operation Indicators” on page 9 for heartbeat operation.
- If the thermostat input indicating lights are not responding appropriately, check the thermostat or a DDC control acting as thermostat inputs into P297.
- Basic cooling and heating functions may be energized to test major unit components by using the CORE unit controller testing function or by using jumper wires on the Field Wiring Termination plug P297.

5.1. CORE Service App Menu Selection Overview

Refer to “11.1. Humiditrol+ Dehumidification Operation — (Humiditrol Reheat)” on page 70 for details for Setup, Data, Service and Settings options.

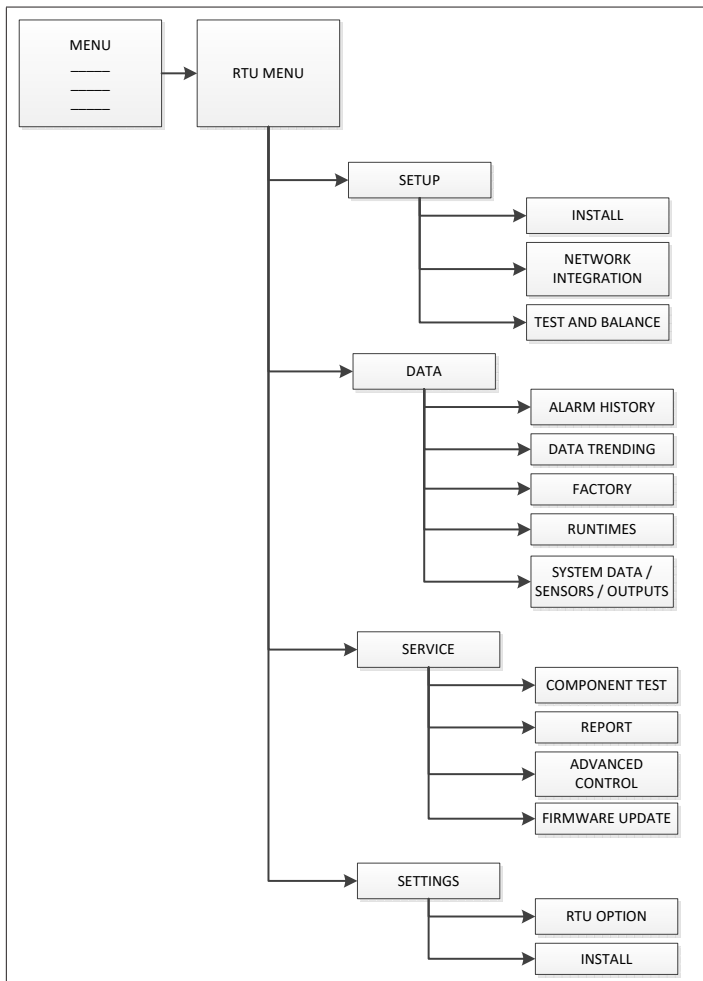


Figure 4. CORE Service App Menu Overview

5.2. Pairing CORE Service App to CORE Unit Controller

The CORE Service App is the user interface for the CORE unit controller. The CORE Service App locates the CORE unit controller if it is within 50 feet of the mobile device.

- The CORE Service App lists the units by signal strength.
- The unit friendly name displays.
- Select the unit from the list. The four-digit code on the unit displays in the list.
- A connection to the mobile device occurs within 10 seconds.
- The RTU name, model number, serial number, and CORE controller bundle firmware version displays after pairing is complete.

5.3. System Overview - Room Sensor Mode

- The system overview emphasizes the zone temperature and RH.
 - The zone temperature / rh indicates a “_ _” if out of range.
 - The RH value will not display if not configured.
- The system overview in room sensor mode places emphasis on the current operating modes.
- The system overview indicates all active operating modes with a priority on heating and cooling associated modes.

NOTE: If dehumidification mode is active, this is displayed and not cooling for example.

- The system overview lists the following parameters at the top of the screen:
 - Return Temperature
 - Discharge Temperature
 - Set Points (Heating and Cooling)
 - Network Status

The system overview also indicates:

- > Occupancy
- > RH setpoint (if applicable)
- > Outdoor Air Temperature
- > Damper Position (if equipped)
- > Active Alerts

- List of Operating Modes

- Test
- Smoke
- Off on Alarm
- Delay up to 5 minutes
- Delay up to 20 seconds
- Start up
- Low Ambient Lockout
- Morning Warm-Up

- Defrost Comp 1
- Defrost Comp 2
- Defrost Comp 1 & 2
- Emergency Heating
- Max Heat
- Booting
- Pre-Cool
- Free Cooling
- Cooling
- Heating
- Dehumidification
- Fresh Air Cooling
- Fresh Air Heating
- Cool + Max Open Economizer
- Cool + Modulate Economizer
- Compressor Load Shedding
- Blower On - OAS
- Blower On
- No Demand - OAS

5.4. Active Alarms

The CORE Service App:

- Indicates active alarm information.
- Indicates the number of occurrences of an alarm in the previous thirty (30) days.
- For alarm details, go to “26. CORE Control System - Alarms” on page 125.

5.5. CORE Service App General Menu + User Preference

- Allows the user to set the temperature units (°F or °C).
- Allows the user to set the screen mode, options are dark or light modes.

5.6. CORE Service App RTU Menu

The following options are available under this menu selection:

5.6.1. Setup

5.6.1.1. Install

This section includes the following:

- Date and time and the option to use the mobile device data and time setting.
- RTU Name
- Model Number (see “Figure 5. Model Number”) and serial number. Model, serial, and catalog numbers are located on the RTU nameplate.
- RTU Information. Configuration ID 1 and 2 can be entered here. See “Figure 6. Configuration ID 1” on page 16 and “Figure 7. Configuration ID 2” on page 16 for further details.

This section addresses the requirement that specific configuration information must be completed using the SETUP / INSTALL feature if a new unit controller was being installed. Other requirements are the addition of accessories that were not factory-installed. Model number, configuration ID 1 and 2, catalog number, serial number and RTU description are all key items required to be completed for the system to operate correctly. Running the SETUP / INSTALL wizard allows the installer to verify all fields have been completed as required.

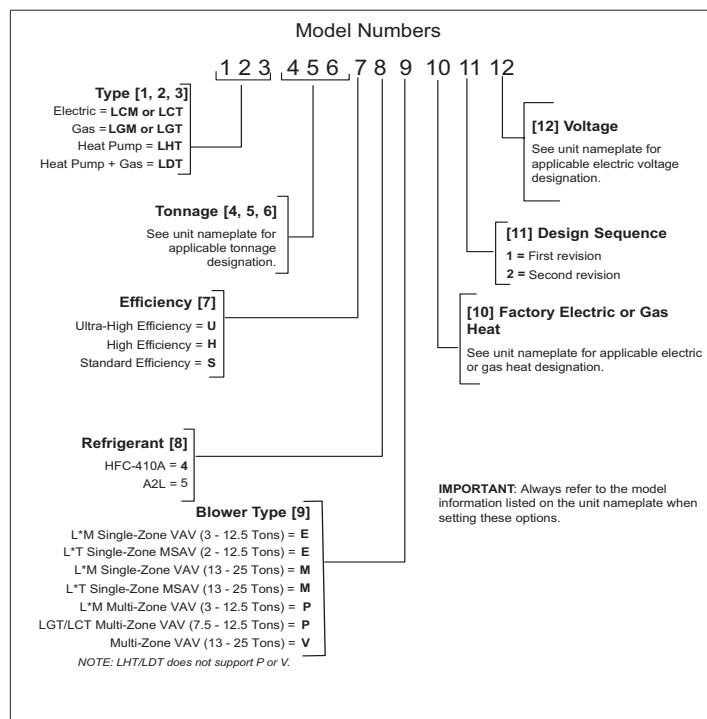


Figure 5. Model Number

5.6.2. Install Menu Navigation

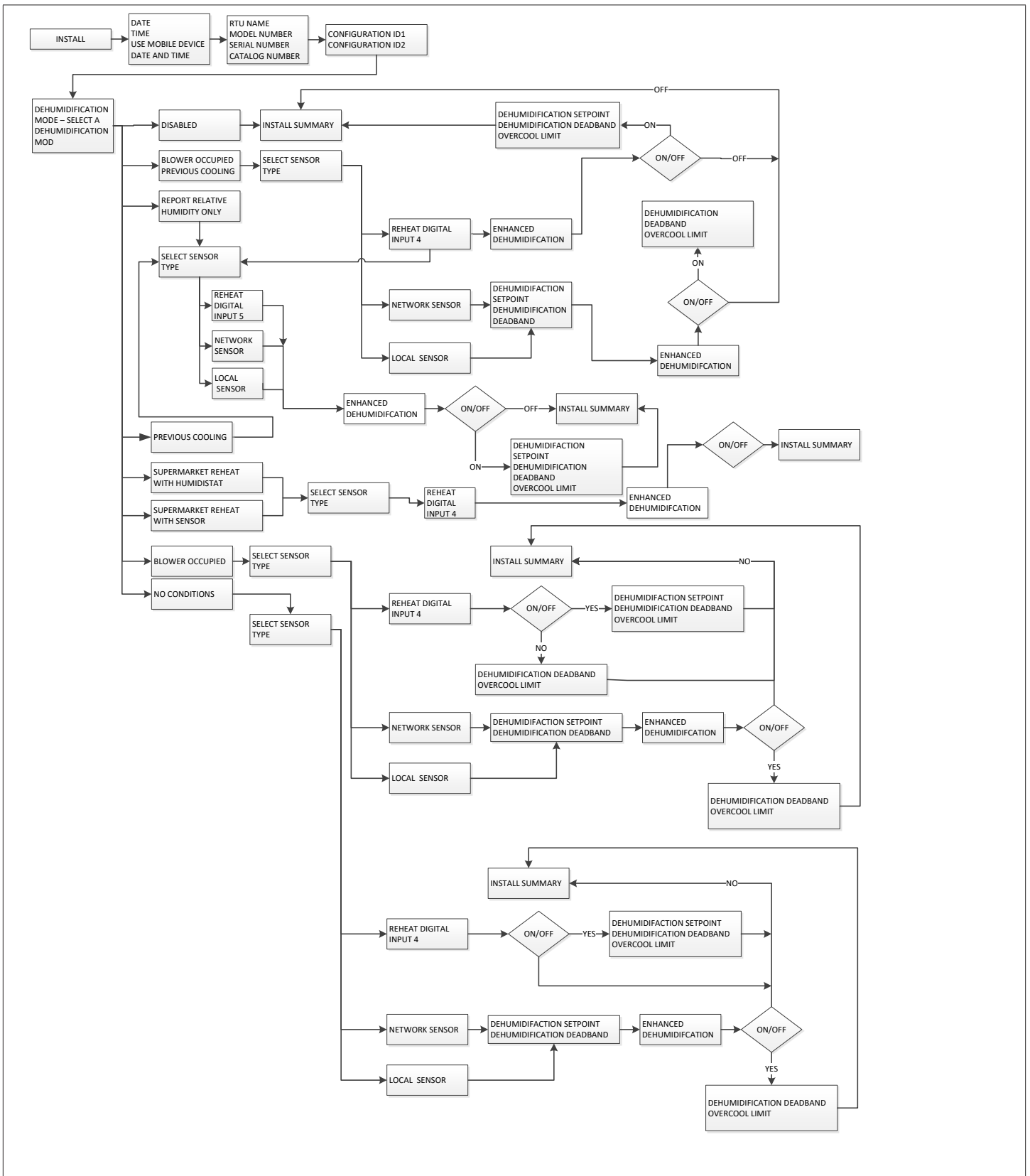


Figure 8. Install Menu Structure

5.6.3. Network Integration

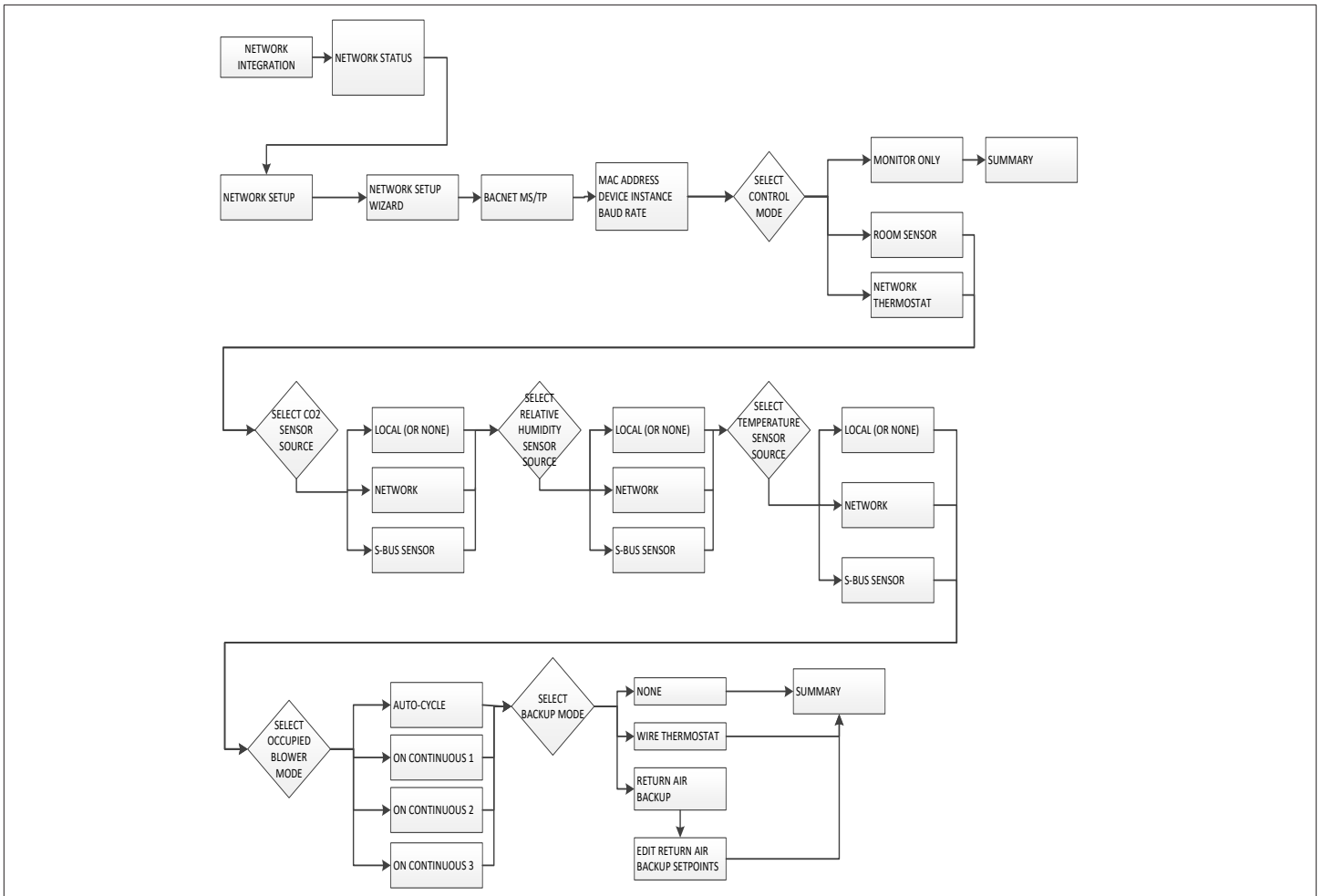


Figure 9. BACNet MS/TP Menu Structure

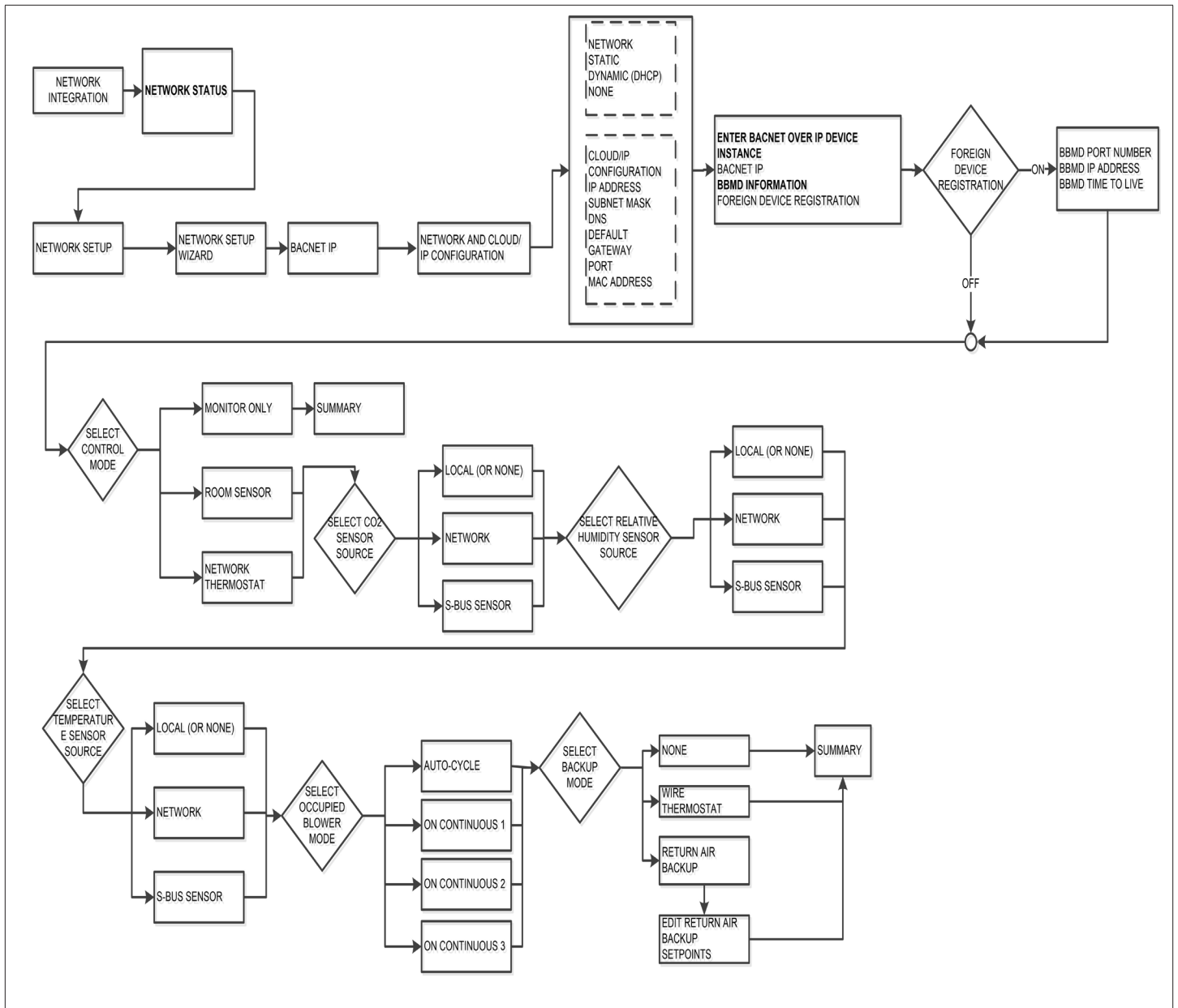


Figure 10. BACNet IP Menu Structure

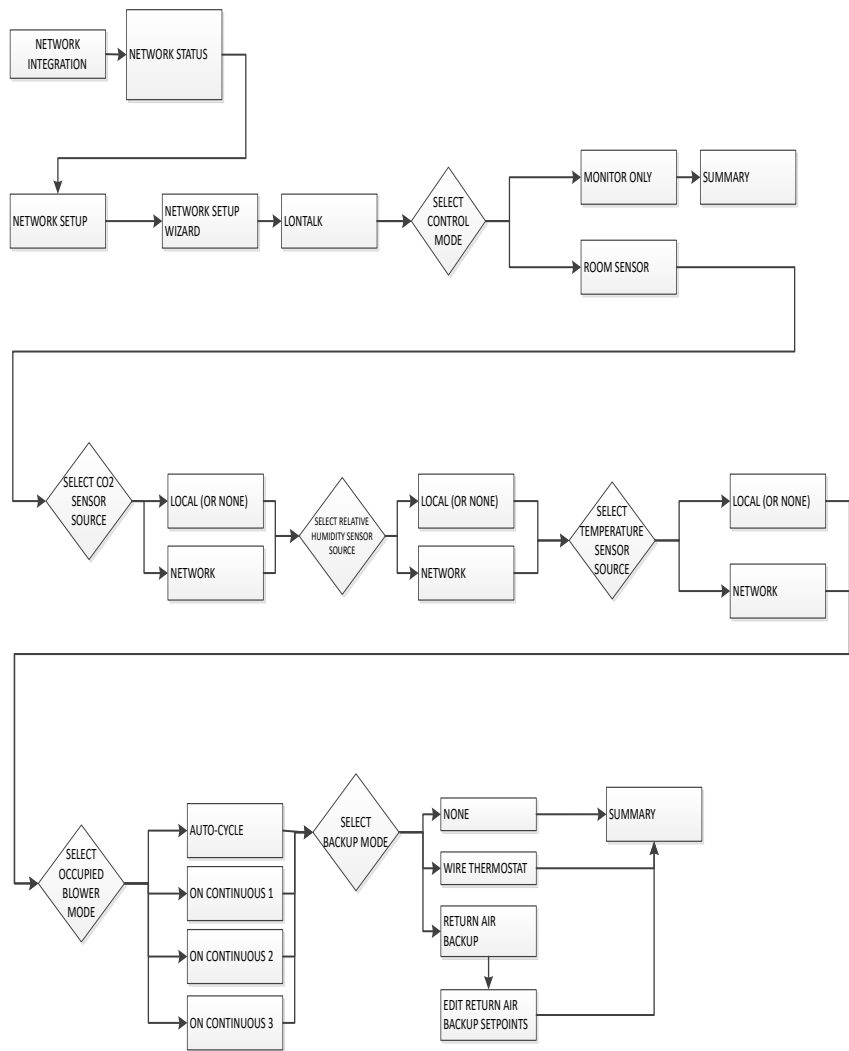


Figure 11. LonTalk Menu Structure

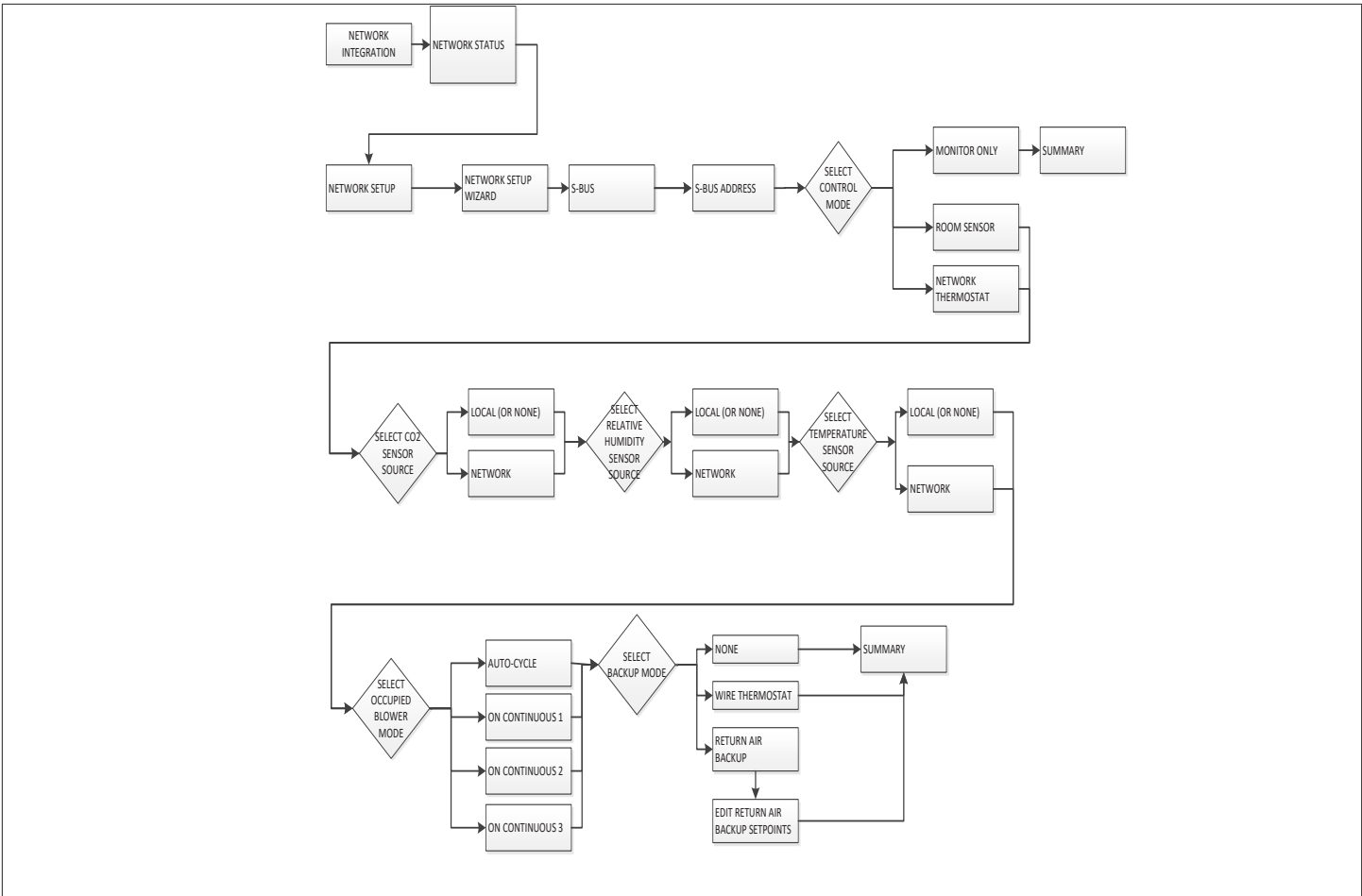


Figure 12. S-BUS Menu Structure

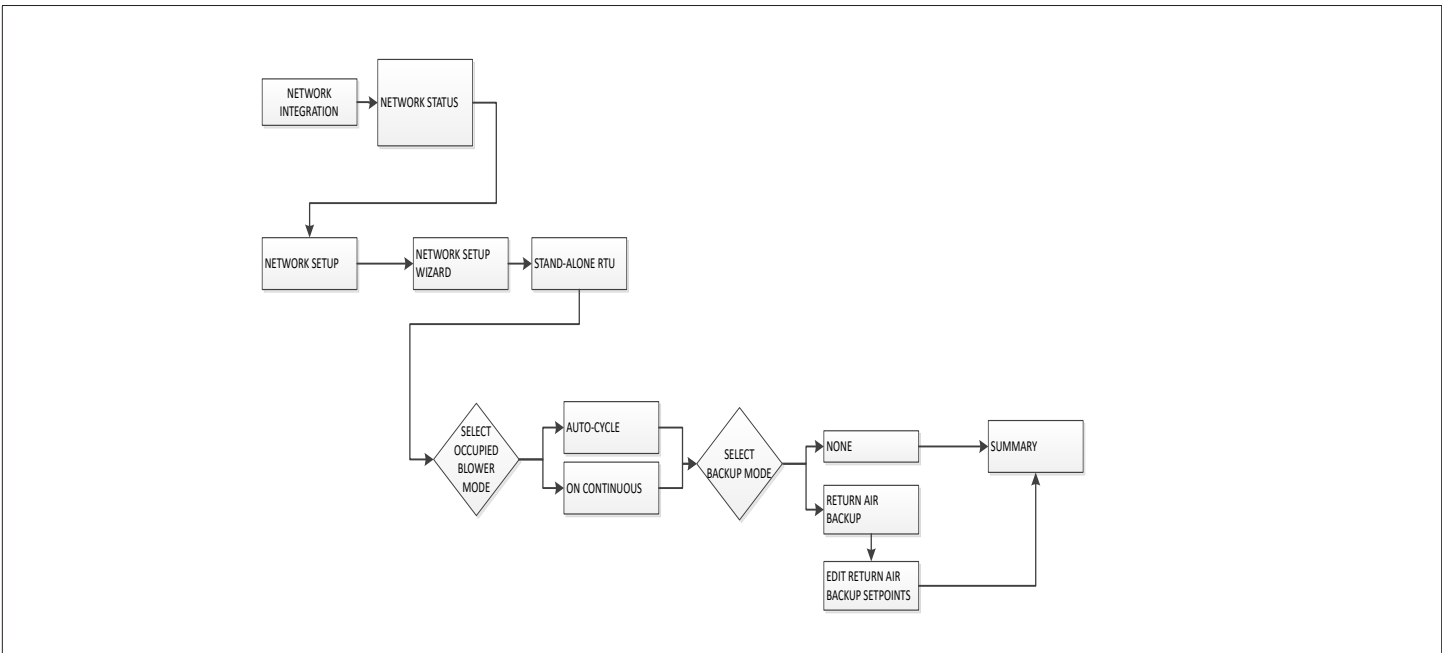


Figure 13. Standalone RTU Menu Structure

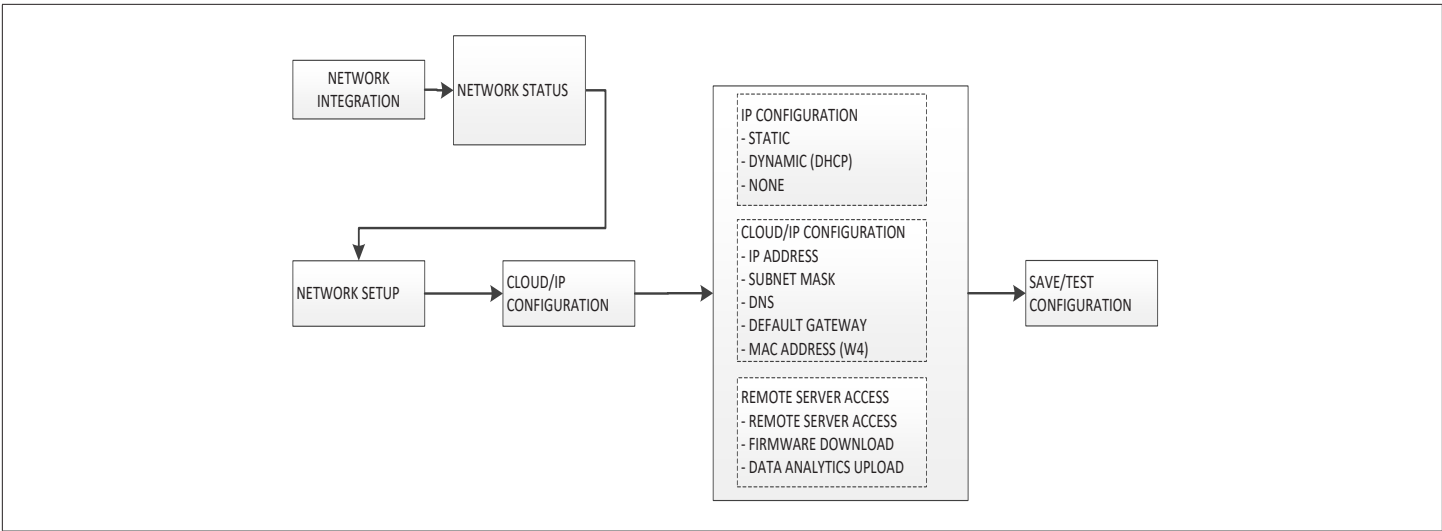


Figure 14. Cloud/IP Configuration Menu Structure

5.6.4. Test and Balance

- Blower: Includes Blower Calibration, SZVAV Blower and VAV Calibration
- Damper: Includes Economizer Options, Free Cooling, Damper Calibration (closed and open)

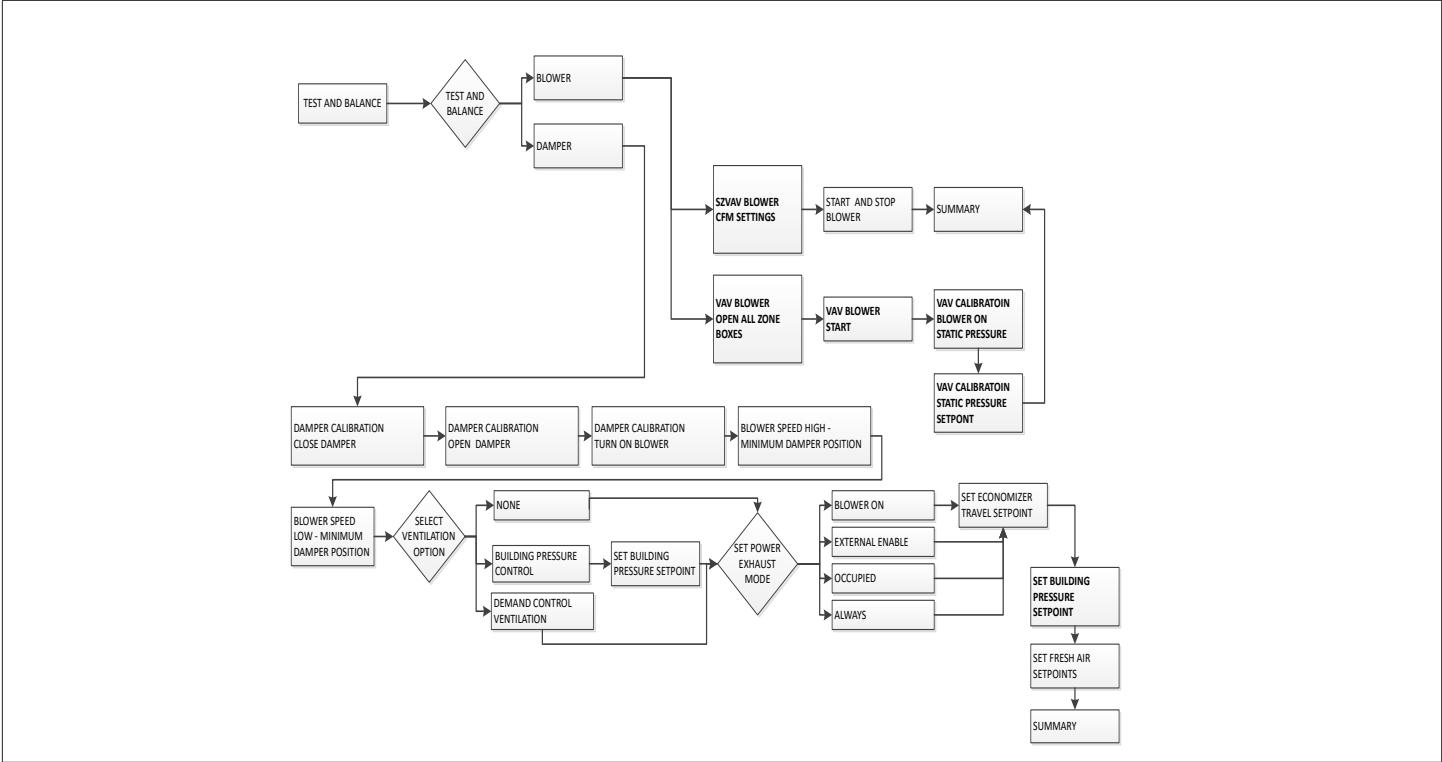


Figure 15. Motorized Outdoor Air Damper Only Menu Structure

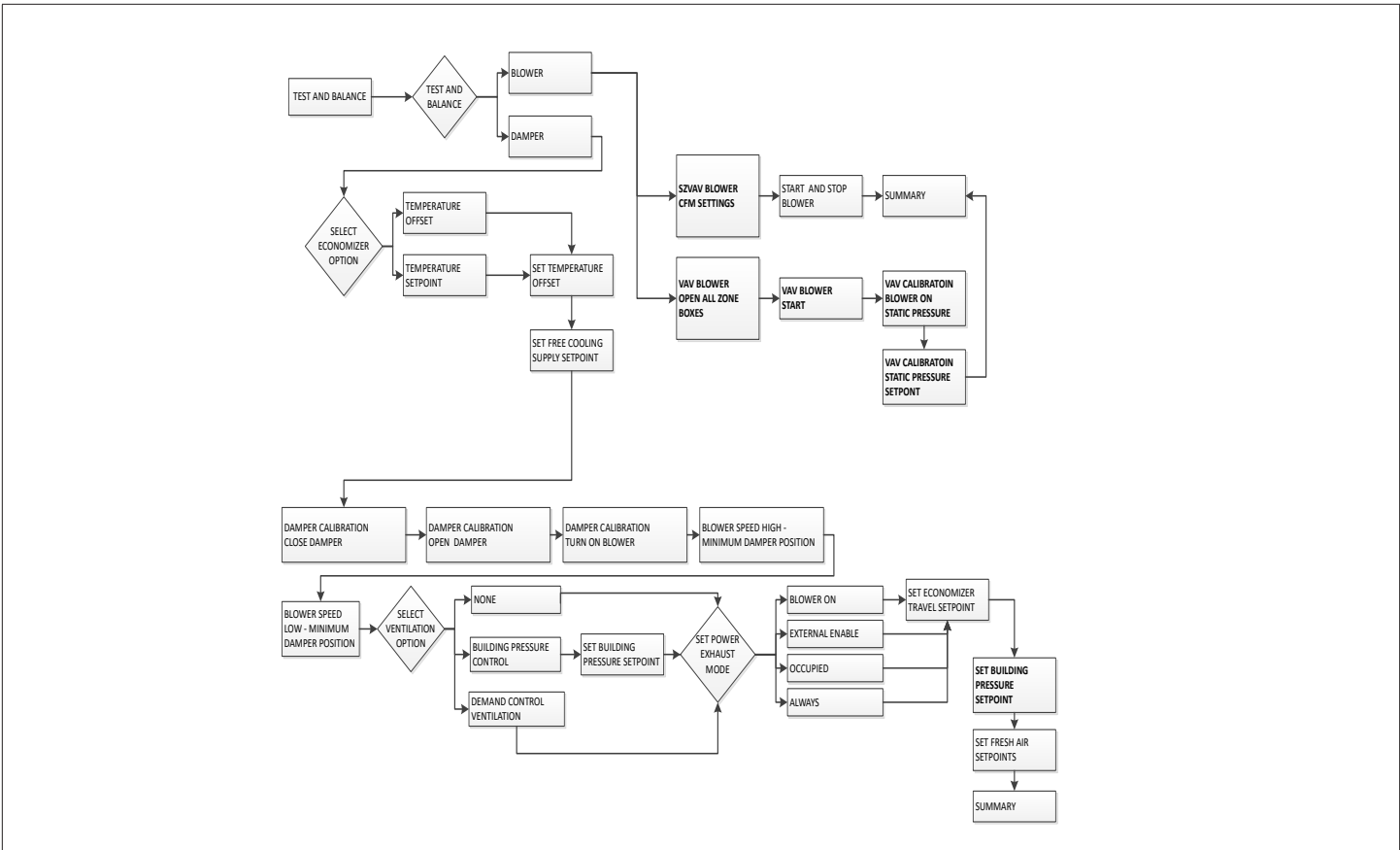


Figure 16. Economizer - Temperature Menu Structure

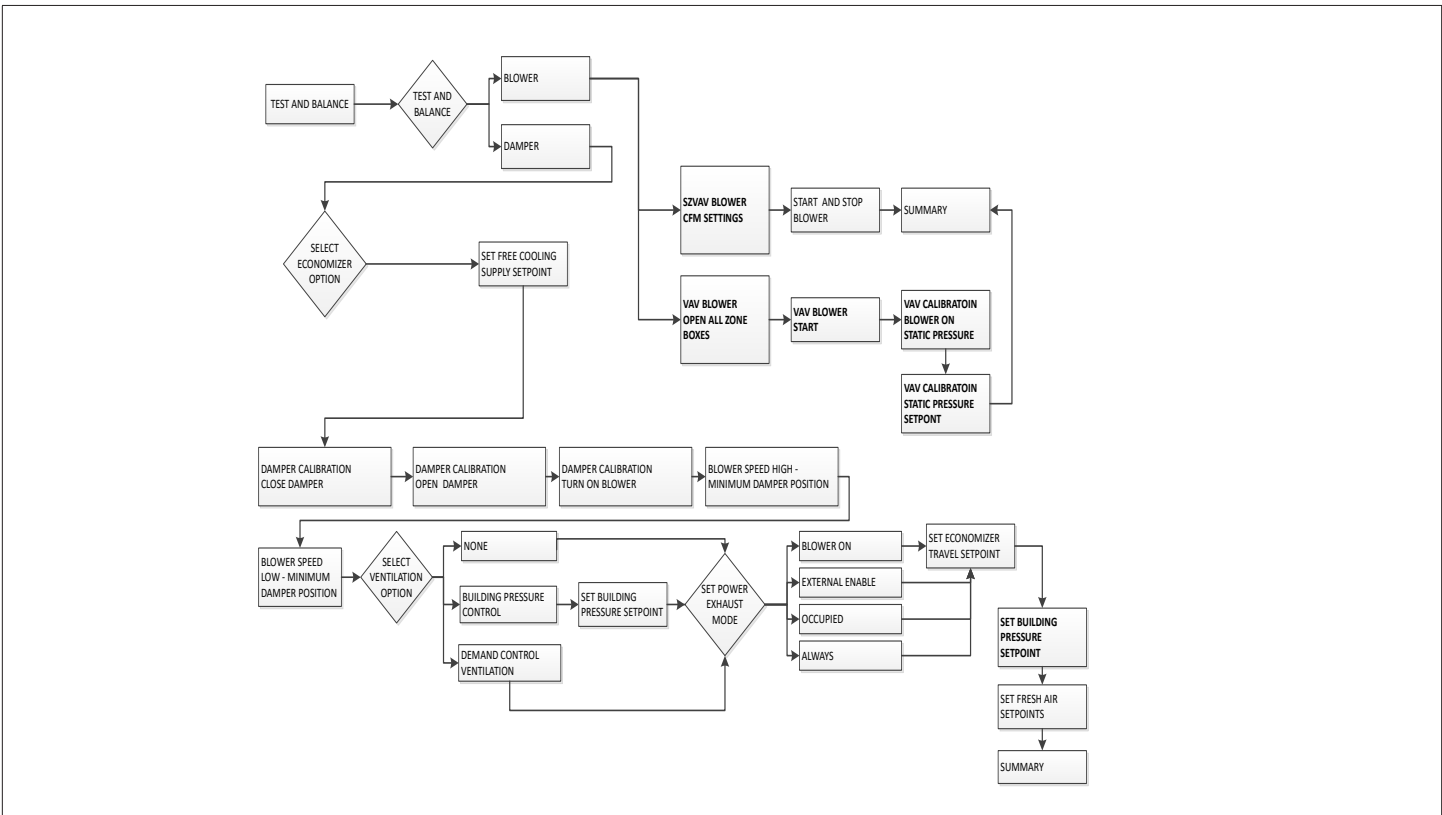


Figure 17. Economizer - Global Menu Structure

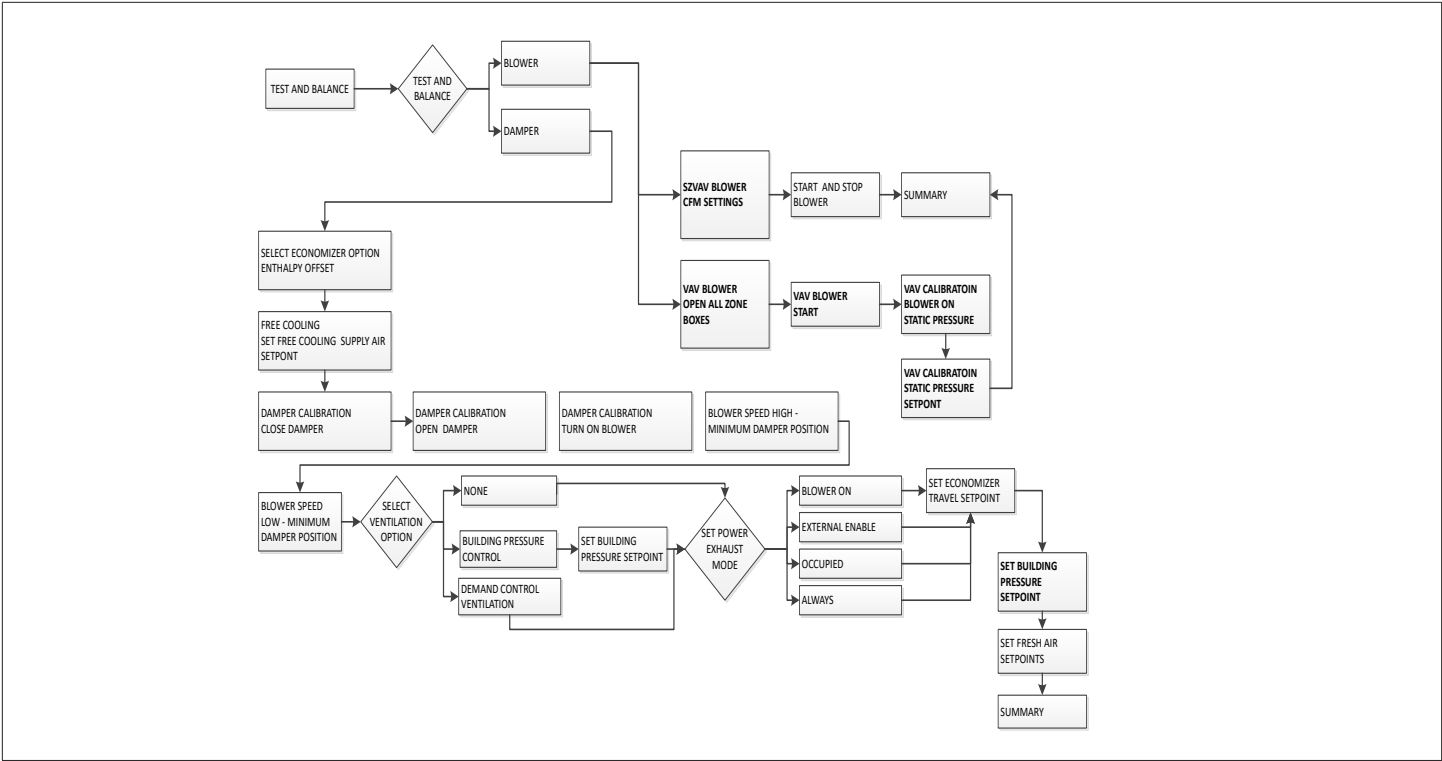


Figure 18. Economizer - Single or Dual Enthalpy Menu Structure

5.7. Data

5.7.1. Alarm History

The M4 unit controller produces active and past alarm codes. As such, the mobile application shows all active alarm codes, and a limited history of formerly-active alarm codes, based upon the storage capacity of the M4 unit controller. The CORE Service Application:

- Displays alarm information received from the M4 unit controller.
- Alarms display in chronological order from most severe to least severe.
- Displays other alarm information such as time of occurrence and troubleshooting information.
- Indicates all alarm information per the active alarm requirements.
- Indicates the number of occurrences of an alarm in the past thirty (30) days.

See “26. CORE Control System - Alarms” on page 125 for alarm details.

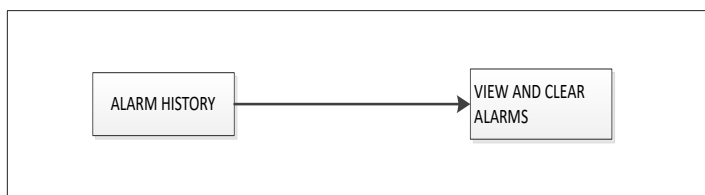


Figure 19. Alarm Menu Structure

5.7.2. Data Trending

The CORE Unit controller allows the user to trend data in real time. The mobile app allows the user to trend sensors and heating/cooling stages. This data is exportable via the app in a comma-separated value (CSV) format.

The main purpose of this feature is for troubleshooting a unit. Having granular, time-sensitive information is critical for this purpose. By default, the trending function will display 15 minutes of data, starting when the user navigates to this menu.

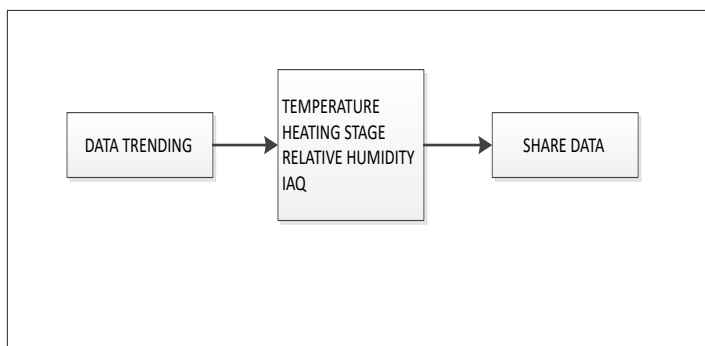


Figure 20. Data Trending Menu Structure

5.7.3. Factory

This section displays the software version, RTU description, catalog number, model number, serial number and configuration IDs 1 & 2.

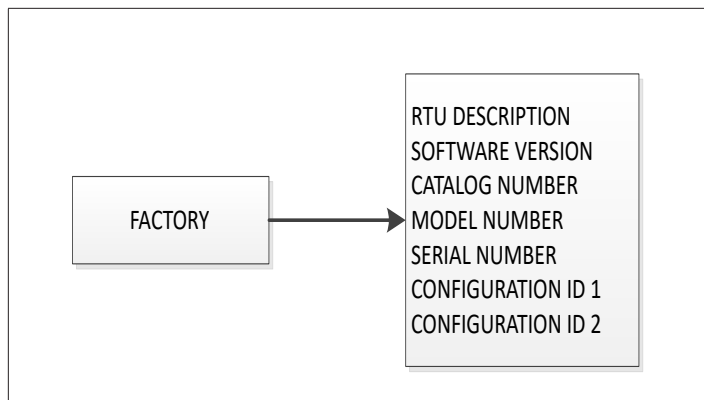


Figure 21. Factory Menu Structure

5.7.4. Runtimes

The mobile application allows the user to view the runtimes of the different system components.

- **Component Runtime** - The mobile application displays hours of runtime for each component. The precision of the measurement is hours:minutes.
- **Runtime Cycles** - The mobile application displays cycles of runtime by component.
- **Clearing of Runtimes** - The mobile application supports clearing of runtime on a component basis.

The available component runtimes are:

- Blower
- Belt
- Compressor(s)
- Condenser Fan(s)
- Filter
- Heat Stage(s)
- Dehumidification Operations
- Power On
- Pre-Install
- Reversing Valve(s)
- Free Cooling Operation
- Power Exhaust Operation

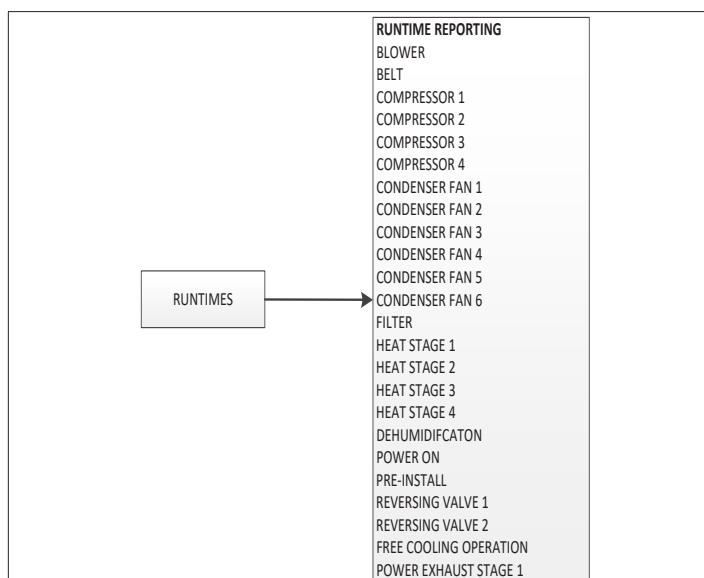


Figure 22. Runtimes Menu Structure

5.7.5. System Data / Sensor Data / Output

The inputs and outputs are as follows:

- Local Inputs. Examples are local thermostat inputs, sensors, digital inputs, setpoints and advanced.
- Network Inputs. Examples are BACnet MS/TP, BACnet IP, Lontalk and S-BUS
- Outputs. Examples are compressor, reheat coil, outdoor fans, heat status, damper, blower, power exhaust and other service relay output and Crankcase Heater 1 through 4.

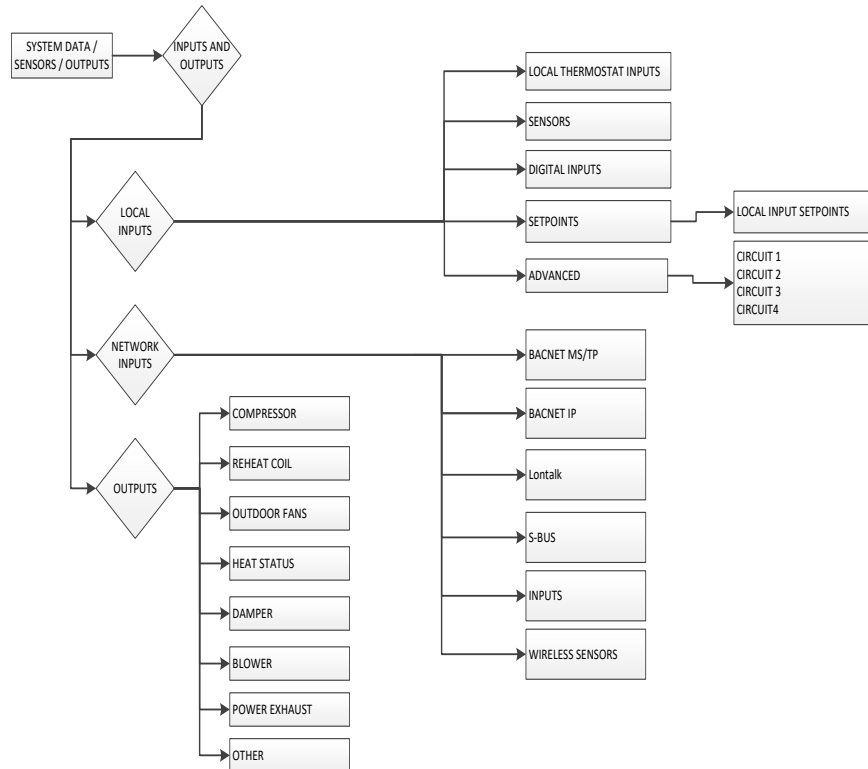


Figure 23. System Data / Sensors / Outputs Menu Structure

5.8. Service

5.8.1. Component Test

For cooling, users can run the following tests:

- Cooling Stages 1 through 4 - Tests are discharge and return air temperatures, compressor status and percent demand.
- SuperHeat and Subcool values of each compressor circuit displays while testing is ongoing for Model L. The blower speed is adjustable during the cooling test.

For heating, users can run the following tests:

- Heat Stages 1 through 4 - Tests are discharge and return air temperatures, and percent demand.

For HP heating (Enlight Models), the following tests can be run:

- Heat Pump Only - temperatures and compressor status are shown during the test.
- HP + Electric - temperatures, compressor status and heater status are shown during the test.

Other tests:

- Blower Speed
- Damper Position
- Outdoor Fans
- Dehumidification
- Outputs
- Defrost (Enlight Models)

See “Figure 24. Component Test Menu Structure” on page 27.

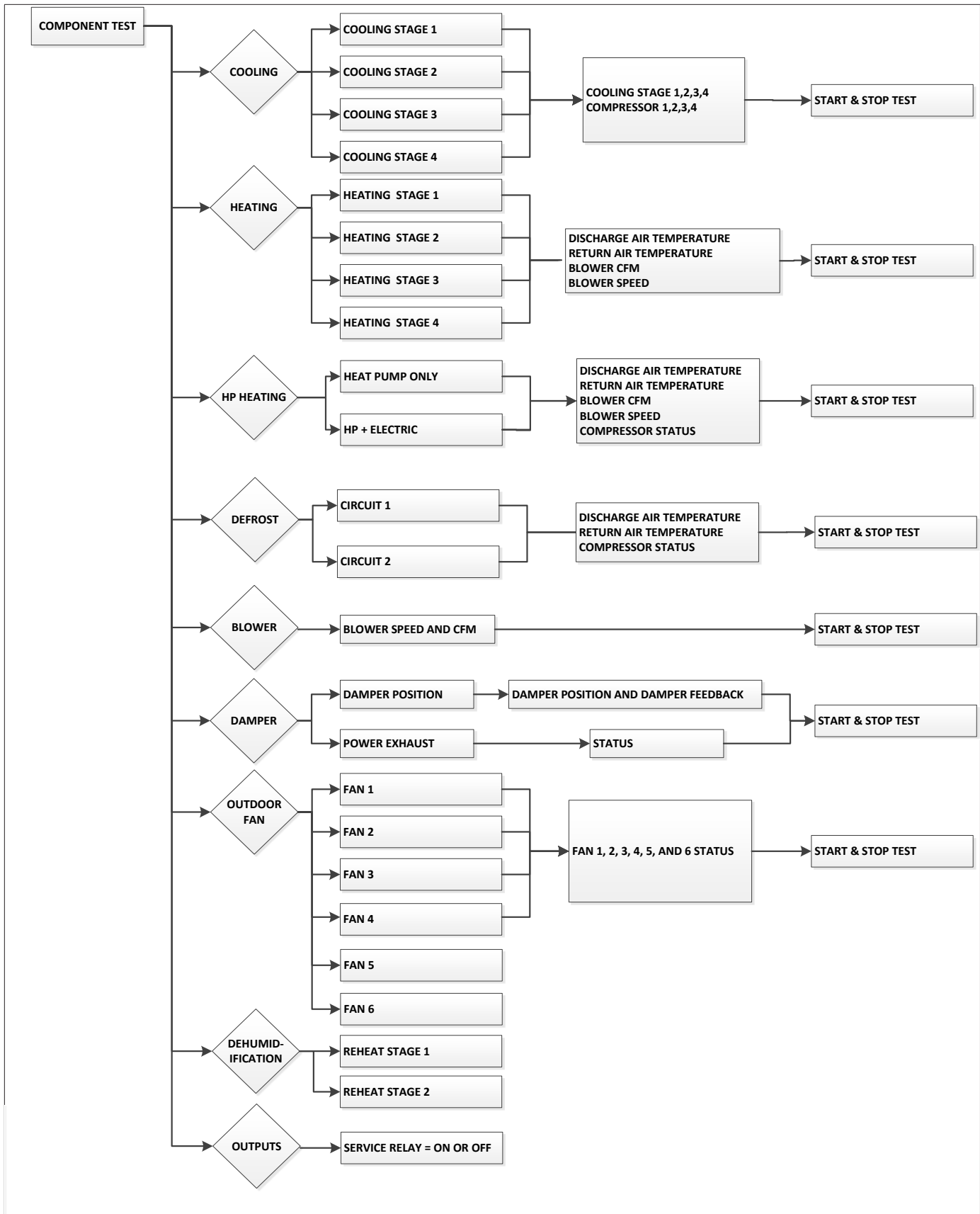


Figure 24. Component Test Menu Structure

5.8.2. Report

This section provides service reports, system logs, system profile and user profile. All logs and reports can be downloaded to a USB flash drive when inserted in the W4 module USB port.

- Service Reports - These reports are saved to the root directory of the USB storage device. In addition, users can save the report to the mobile device or text or e-mail the report.
- System Logs - These logs are saved to the root directory of the USB storage device. In addition, users can save the report to the mobile device, e-mail or share the log using the device's share feature. There is also an option for data analytic uploads.
- System and User Profile - The profile is saved to the root directory of the USB storage device. In addition, users can save the profile to the mobile device or e-mailed to an e-mail account. Users can also explore the option of loading a system profile from the USB. System profiles can be used to copy configuration from and to similar units.

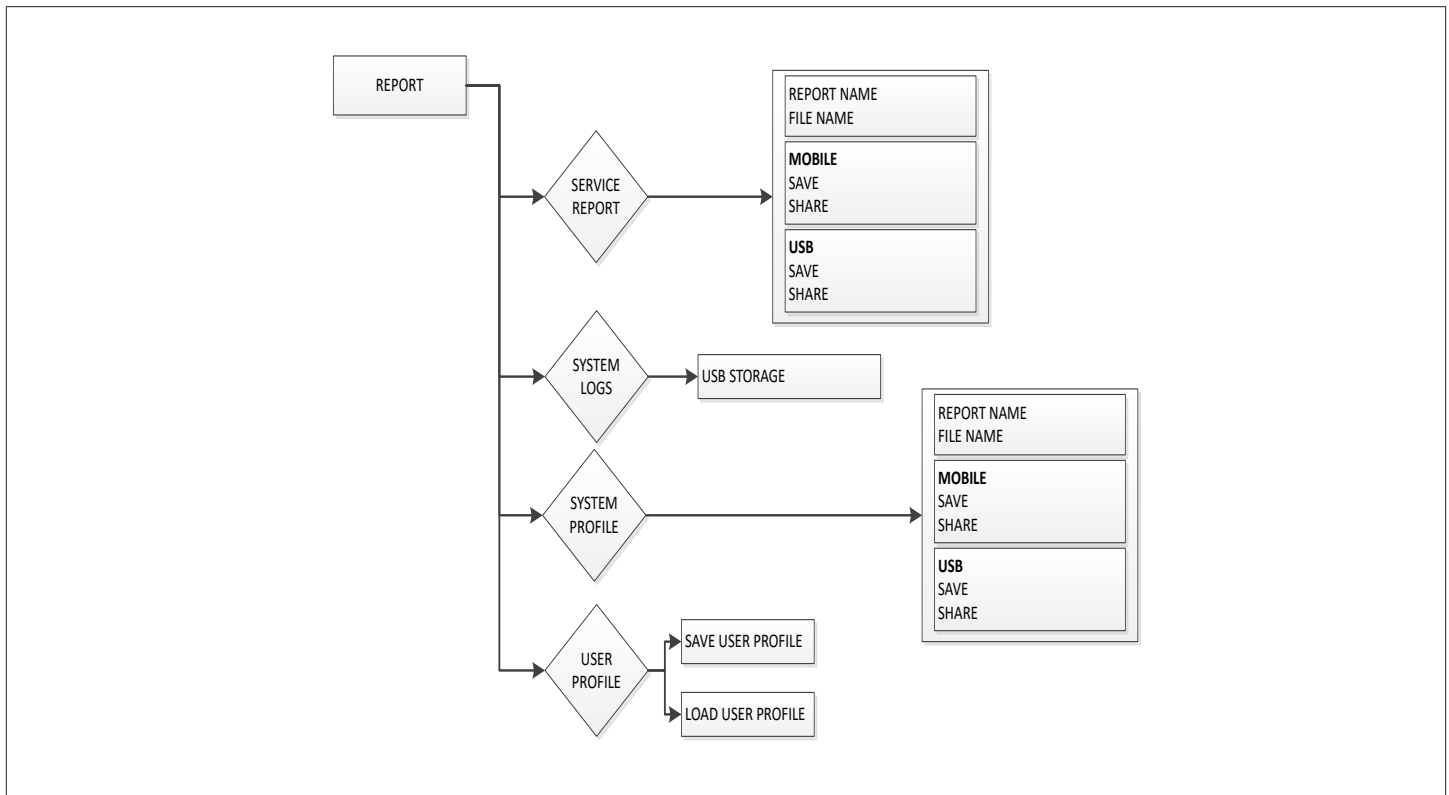


Figure 25. Report Menu Structure

5.8.3. Advanced Control

Features are:

- **Controller Reset (Reboot)** - This button asks for confirmation before performing a power reset on the M4 Controller.

NOTE: The mobile app must be paired (again) to the controller after reboot occurs.

- **Clear Delays** - This functionality clears system delays and timers. This includes staging timers and safety delays.
- **Controller Lockout** - Prevents the controller from operating the unit to meet any space comfort demands while it is Locked Out. In this locked out state, the unit can still be monitored on the network but can not operate the RTU.

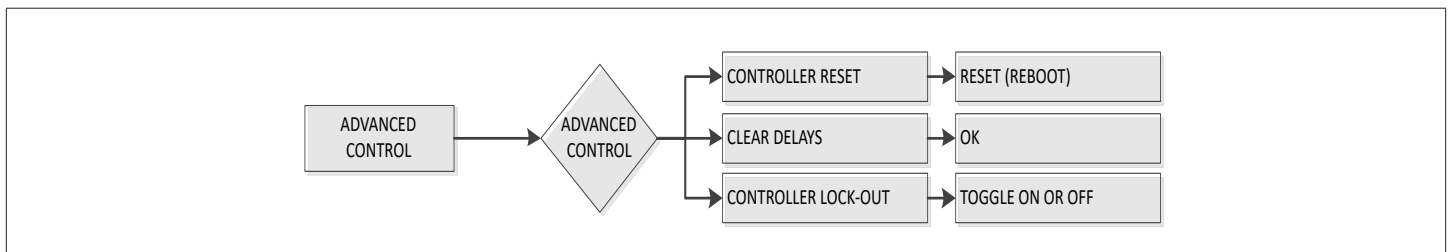


Figure 26. Advanced Control Menu Structure

5.9. Settings

5.9.1. RTU Options

Settings available are:

- Blower - Speed and VFD Bypass options
- Damper - Economizer Temperature and Economizer type with settings for Temperature offset and setpoint
- Dehumidifier
- Power Exhaust
- Edit Parameters - Categories are cooling, heating, air flow, VAV, economizer, control options, and miscellaneous

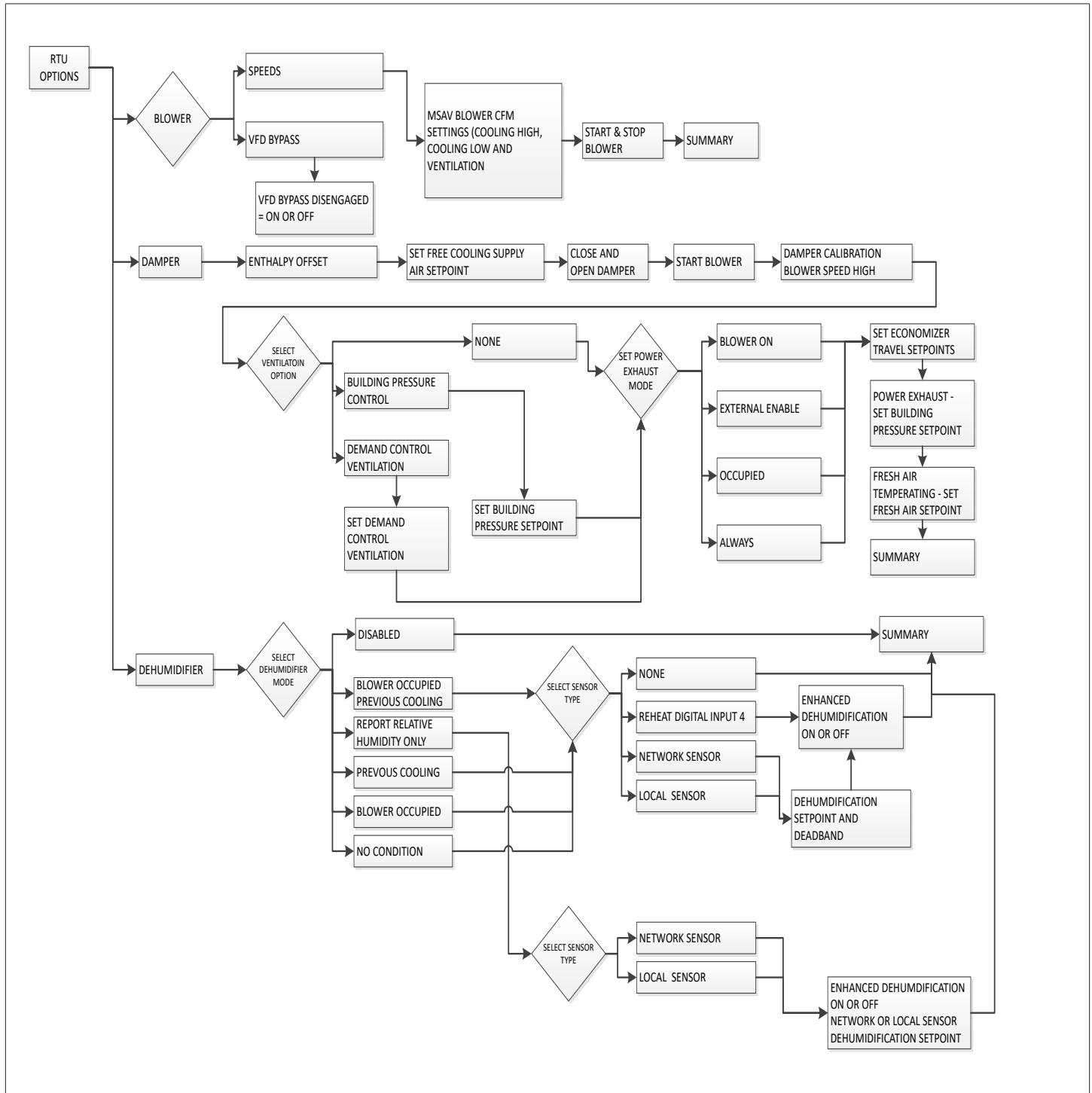


Figure 27. RTU Options - Blower, Damper, and Dehumidifier

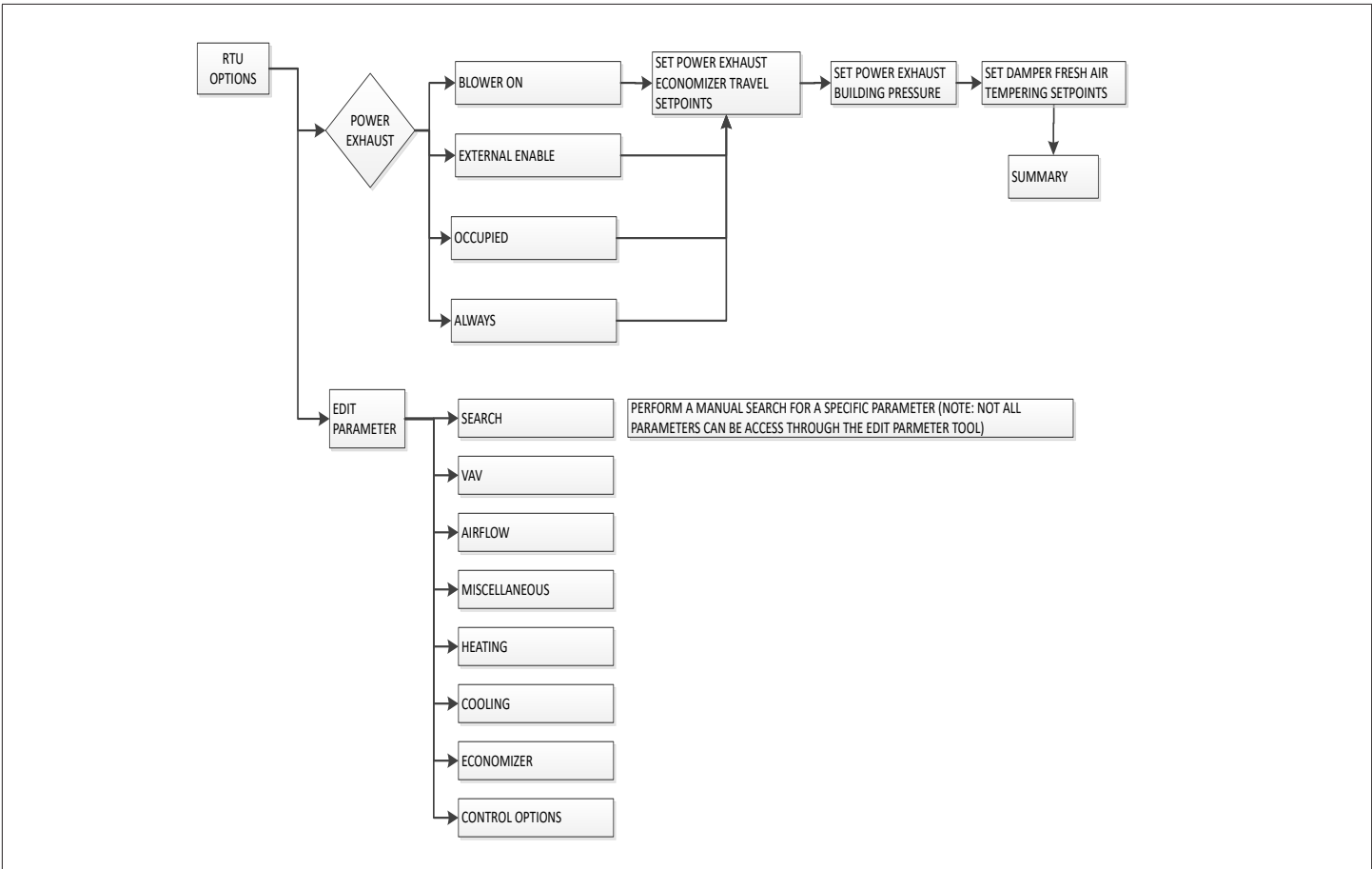


Figure 28. Settings - Power Exhaust and Edit Parameter

5.9.2. Install

The mobile application provides a menu to run “New Unit Setup.”

- New Unit setup directs the user towards the install menu.
- The mobile application provides a menu to run “Install New M4” (CORE unit controller).
- Install new CORE unit controller confirms whether the user wants to “Clear All Configuration.”
- If the user confirms to “Clear All Configuration,” the app asks the user if they are sure.
- If the user confirms, the menu directs the user towards the Setup >RTU Menu > INSTALL.
- If the user cancels at any point, the user is directed back to the Setup >RTU Menu > INSTALL.

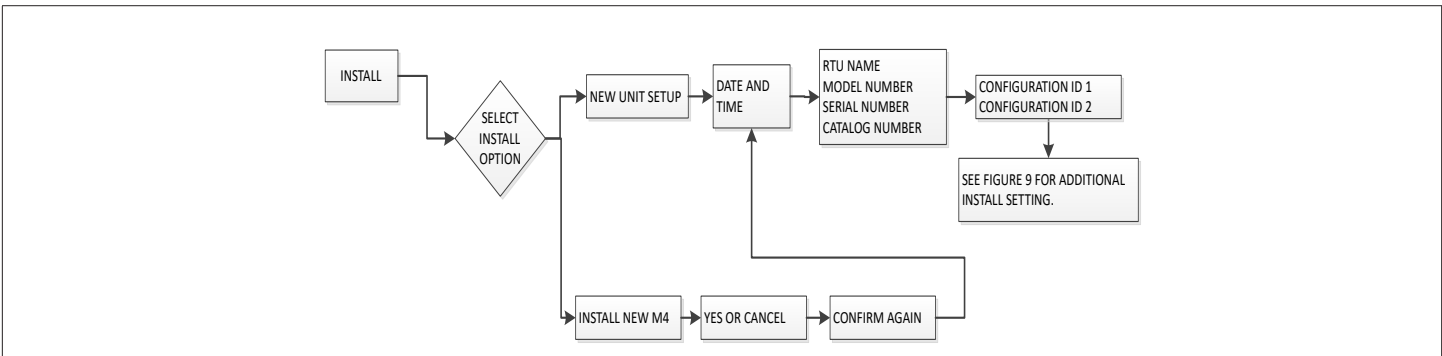


Figure 29. Settings - Install

6. Main Controller Operations

6.1. Control Type - Thermostat

The M4 unit controller operates the system from a wired thermostat, room sensor, or zoning system based on the System Mode selected in:

Go to RTU MENU > NETWORK INTEGRATION > NETWORK SETUP WIZARD > WIRED THERMOSTAT

The default control type is wired thermostat.

Direct Digital Control (DDC) applications use thermostat mode for two- or three-stage cooling and two or three-stage heating. Units are shipped from the factory configured for control type using a wired thermostat. The M4 unit controller will operate two-stages of heating and cooling based on the thermostat Y1, Y2, W1, W2, G, and OCP (occupied) demands.

6.1.1. Cooling Stages

The M4 unit controller allows five different staging options:

Go to RTU MENU > RTU OPTIONS > EDIT PARAMETER > (search)111 >
111 COOL STAGING OPTION

- **Option 0. No cooling operation.**
- **Option 1. Two Cooling Stages:** Y2 demand brings on all mechanical stages of cooling during economizer operation.

NOTE: Option 1 does not apply to Model L units.

- **Option 2. (Default) Two Cooling Stages:** Cooling operation is shown in “Table 7. Thermostat Mode Operation Default (Two Cooling Stages Parameter 111)” on page 32. Y2 demand brings 1/2 or 2/3 mechanical stages of cooling during economizer operation.
- **Option 3. Three Cooling Stages:** Cooling operation is shown in “Table 8. Thermostat Mode Operation (Three Cooling Stages Parameter 111)” on page 32; this option requires the use of a three-stage cool thermostat and a K27 relay. See wiring pictorial in “Figure 30. Third-Stage Cool (Parameter 111) Wiring” on page 31 and C section control wiring diagram.
- **Option 4. Discharge Air Control - Up to Four Stages:** Discharge Air Control Cooling (DACC) option automatically cycles up to four stages of cooling to maintain a discharge air temperature within specific tolerances of discharge air control cooling setpoint (occupied or unoccupied). See Parameters 180 and 181.

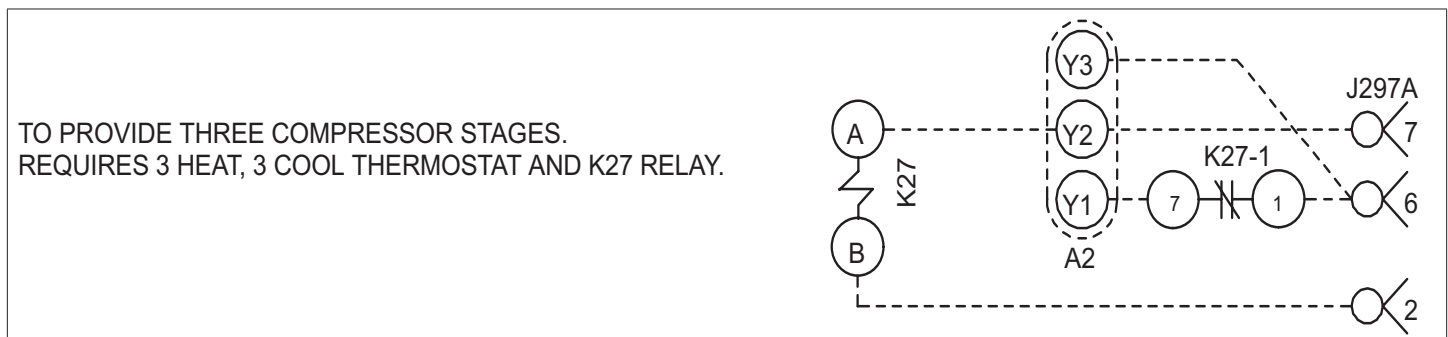


Figure 30. Third-Stage Cool (Parameter 111) Wiring

6.1.1.1. Model L

**Table 7. Thermostat Mode Operation Default
(Two Cooling Stages Parameter 111)**

Economizer	Demand	Compressor 1	Compressor 2 - 4 (if present)	Blower	Y2 Demand Adds
NO	Y1	Modulate to maintain DAT setpoint (parameter 375)	As needed to maintain DAT	Low	Tracks blower CFM
	Y2			High	
YES*	Y1	OFF	OFF	Low/High**	Modulate to maintain FC DAT setpoint (parameter 159)
	Y2	Modulate to maintain 45°F DAT setpoint (parameter 159)	As needed to maintain DAT	High	Max Open

* Assumes outdoor air is suitable for cooling.

** If damper is full open for 5 minutes blower goes to High.

Compressor 1 is a Variable Speed Compressor.

**Table 8. Thermostat Mode Operation
(Three Cooling Stages Parameter 111)**

Economizer	Demand	Compressor 1	Compressor 2 - 4 (if present)	Blower	Y2 Demand Adds
NO	Y1	Modulate to maintain DAT setpoint (parameter 375)	As needed to maintain DAT	Low	Tracks blower CFM
	Y2			Med_Hi	
	Y3			High	
YES*	Y1	OFF	OFF	Low/Med_Hi**	Modulate to maintain FC DAT set point (parameter 159)
	Y2	Modulate to maintain 45°F DAT setpoint (parameter 159)	As needed to maintain DAT	Med_Hi	Max Open
	Y3			High	

* Assumes outdoor air is suitable for cooling.

** If damper is full open for 5 minutes blower goes to Med_Hi.

Compressor 1 is a Variable Speed Compressor.

6.1.1.2. Enlight / Strategos

**Table 9. Enlight / Strategos Thermostat Mode Operation
(Two Cooling Stages Parameter 111 Default)**

Number of Compressors	No Economizer		With Economizer*	
	Y1 Demand	Y2 Demand Adds	Y1 Demand	Y2 Demand Adds
1 (2-Stage)	CP1@PL	CP1@FL	Free Cool	CP1@PL
2 (2-Stage + Fixed Speed)	CP1@FL	CP2	Free Cool	CP1@FL
3 (All Fixed Speed)	CP1 + CP2	CP3	Free Cool	CP1 + CP2 (1)
4 (All Fixed Speed)	CP1 + CP2	CP3 + CP4	Free Cool	CP1 + CP2 (1)

CP1 = Compressor 1; CP2 = Compressor 2; CP3 = Compressor 3; CP4 = Compressor 4

For 2-Stage Compressors (@PL = Partial Load, @FL = Full Load

(1) - Parameter 111, option 1 will start all available mechanical cooling

*Assumes outdoor air is suitable for cooling.

**Table 10. Enlight Heat Pump (D Box) Thermostat Mode Operation
(Two Cooling Stages Parameter 111 Default)**

Number of Compressors	No Economizer		With Economizer*	
	Y1 Demand	Y2 Demand Adds	Y1 Demand	Y2 Demand Adds
1 (2-Stage)	CP1@PL	CP1@FL	Free Cool	CP1@PL
2 (All Fixed Speed)	OFF	CP2	Free Cool	OFF

CP1 = Compressor 1; CP2 = Compressor 2

For 2-Stage Compressors (@PL = Partial Load, @FL = Full Load

(1) - Parameter 111, option 1 will start all available mechanical cooling

*Assumes outdoor air is suitable for cooling.

**Table 11. Enlight Heat Pump (D Box) Thermostat Mode Operation
(Three Cooling Stages Parameter 111 Default)**

Number of Compressors	No Economizer			With Economizer*		
	Y1 Demand	Y2 Demand Adds	Y3 Demand Adds	Y1 Demand	Y2 Demand Adds	Y3 Demand Adds
1 (2-Stage)	CP1@PL	CP1@FL	CP1@FL	Free Cool	CP1@PL	CP1@PL
2 (All Fixed Speed)	OFF	CP2	CP2	Free Cool	OFF	CP2

CP1 = Compressor 1; CP2 = Compressor 2
 For 2-Stage Compressors (@PL = Partial Load, @FL = Full Load
 (1) - Parameter 111, option 1 will start all available mechanical cooling
 *Assumes outdoor air is suitable for cooling.

**Table 12. Enlight / Strategos Thermostat Mode Operation
(Three Cooling Stages Parameter 111)**

Number of Compressors	No Economizer			With Economizer*		
	Y1 Demand	Y2 Demand Adds	Y3 Demand Adds	Y1 Demand	Y2 Demand Adds	Y3 Demand Adds
1 (2-Stage)	CP1@PL	CP1@FL	NO CHANGE	Free Cool	CP1@PL	CP1@FL
2 (2-Stage + Fixed Speed)	CP1@PL	CP2	CP1@FL	Free Cool	CP1@PL	CP1@FL
3 (All Fixed Speed)	CP1	CP2	CP3	Free Cool	CP1	CP2
4 (All Fixed Speed)	CP1 + CP2	CP3	CP4	Free Cool	CP1 + CP2	CP3

CP1 = Compressor 1; CP2 = Compressor 2; CP3 = Compressor 3; CP4 = Compressor 4
 For 2-Stage Compressors (@PL = Partial Load, @FL = Full Load
 (1) - Parameter 111, option 1 will start all available mechanical cooling
 *Assumes outdoor air is suitable for cooling.

6.1.1.3. Strategos (Heat Pump)

**Table 13. Strategos Heat Pump Thermostat Mode Operation
(Two Cooling Stages Parameter 111 Default)**

Economizer	Demand	Compressor 1	Compressor 2 (if present)	Blower	Damper Status
NO	Y1	Modulate to maintain DAT setpoint (parameter 375)	As needed to maintain DAT	Low	Not Applicable
	Y2			High	
YES*	Y1	OFF	OFF	Low/Med_Hi**	Modulate to maintain FC DAT set point (parameter 159)
	Y2	Modulate to maintain 45°F DAT setpoint	As needed to maintain DAT	High	Max Open

* Assumes outdoor air is suitable for cooling.
 ** If damper is full open for 5 minutes blower goes to High.
 Compressor 1 and compressor 2 are variable speed compressors.

**Table 14. Strategos Heat Pump Thermostat Mode Operation
(Three Cooling Stages Parameter 111)**

Economizer	Demand	Compressor 1	Compressor 2 (if present)	Blower	Damper Status
NO	Y1	Modulate to maintain DAT setpoint (parameter 375)	As needed to maintain DAT	Low	Not Applicable
	Y2			Med_Hi	
	Y3			High	
YES	Y1	OFF	OFF	Low/Med_Hi**	Modulate to maintain FC DAT set point (parameter 159)
	Y2	Modulate to maintain 45°F DAT setpoint	As needed to maintain DAT	Med_Hi	Max Open
	Y3			High	

* Assumes outdoor air is suitable for cooling.
 ** If damper is full open for 5 minutes blower goes to Med_Hi.
 Compressor 1 and compressor 2 are variable speed compressors.

6.1.2. Heating Stages

The Lennox® CORE unit controller allows four different staging options.

Go to RTU MENU > SETTINGS > RTU OPTIONS > EDIT PARAMETER = 112 (HEAT STAGING OPTION)

Available sections are:

- **Option 0. No heating operation.**
- **Option 1. Discharge Air Control - Up to Four Stages.** The Discharge Air Control Heating (DACH) option automatically cycles up to four stages of heating to maintain a discharge air temperature within specific tolerances of discharge air control heating setpoints (occupied or unoccupied). See Parameters 174 and 175.
- **Option 2. (Default) Thermostat or Room Sensor operation.** SC, SG, LC and LG units with two, two-stage heat sections support up to four-stage operation in Room Sensor mode. LH and LD units with two-stage secondary heat support up to three-stage operation in Room Sensor mode. All other units support up to two stages in Room Sensor control mode. See the tables below for details.
- **Option 3. Three Stage Thermostat.** SH and SD units with two stage secondary heat support up to three stage operation in Thermostat mode. This option requires the use of a three stage heat thermostat and K98 relay. See "Figure 31. Third Stage Heat (Parameter 112) Wiring" on page 34 and C section control wiring diagram.

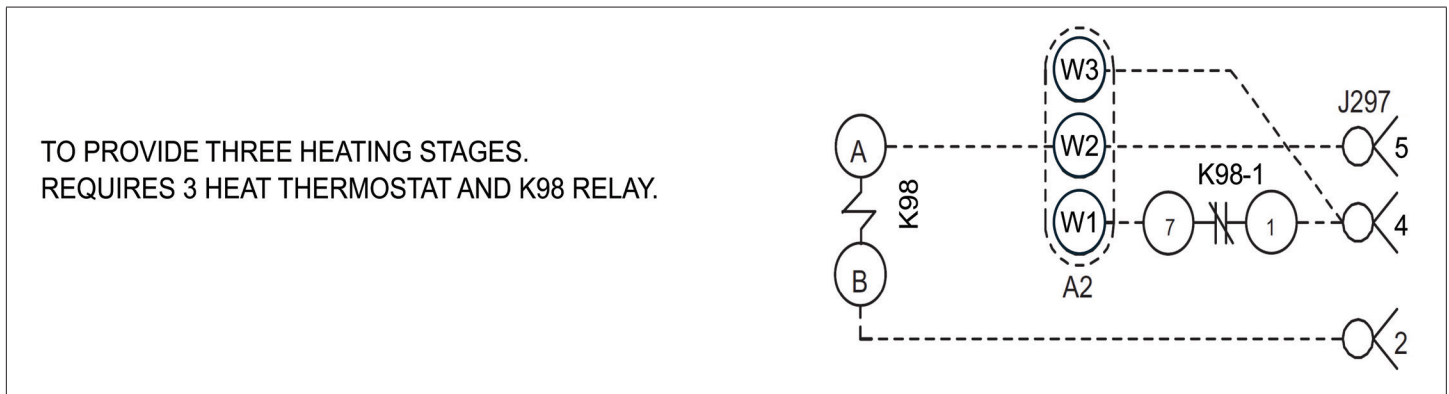


Figure 31. Third Stage Heat (Parameter 112) Wiring

6.1.2.1. Model L, Enlight, and Strategos Electric / Gas (LCM, LCT, LGM, LGT, SCH & SGH)

Electric and Gas staging are identical for these models. The heat section or gas valve is denoted in the tables as "HS."

Table 15. Thermostat Mode Operations (Default) - Electric/Gas Heat

Heat Equipment		W1 Demand	W2 Demand
1 Section	1 Stage	HS1	N/A
	2 Stages	HS1@Low	HS1@High
2 Sections	1 Stage	HS1 + HS2	N/A
	2 Stages	HS1@Low + HS2@Low	HS1@High + HS2@High

HS1 = Electric/Gas Heat Section 1; HS2 = Electric/Gas Heat Section 2

Table 16. Room Sensor Mode Operation - Electric / Gas Heat

Heat Equipment		H1 Demand	H2 Demand	H3 Demand	H4 Demand
1 Section	1 Stage	HS1	N/A	N/A	N/A
	2 Stages	HS1@Low	HS1@High	N/A	N/A
2 Sections	1 Stage	HS1 + HS2	N/A	N/A	N/A
	2 Stages	HS1@Low	HS1@Low + HS2@Low	HS1@High + HS2@Low	HS1@High + HS2@High

HS1 = Electric/Gas Heat Section 1; HS2 = Electric/Gas Heat Section 2

6.1.2.2. Enlight Heat Pump (LHT)

Table 17. Thermostat Mode Operation (Default) - Heat Pump w/Electric Heat

Electric Heat Equipment		W1 Demand	W2 Demand
None	N/A	HP	N/A
1 Section	1 Stage	HP	HP + ES1
	2 Stages	HP	HP + ES1@High
2 Sections	1 Stage	HP	HP + ES1 + ES2
	2 Stages	HP	HP + ES1@High + ES2@High

HP = Heat Pump; ES1 = Electric Heat Section 1; ES2 = Electric Heat Section 2

Table 18. Room Sensor Mode Operation - Heat Pump w/Electric Heat

Electric Heat Equipment		H1 Demand	H2 Demand	H3 Demand
None	N/A	HP	N/A	N/A
1 Section	1 Stage	HP	HP + ES1	N/A
	2 Stages	HP	HP + ES1@Low	HP + ES1@High
2 Sections	1 Stage	HP	HP + ES1 + ES2	N/A
	2 Stages	HP	HP + ES1@Low + ES2@Low	HP + ES1@High + ES2@High

HP = Heat Pump; ES1 = Electric Heat Section 1; ES2 = Electric Heat Section 2

6.1.2.3. Enlight Dual Fuel (LDT)

Table 19. Thermostat Mode Operation (Default) - Dual Fuel

Gas Valve Equipment		W1 Demand	W2 Demand
1 Gas Valve	1 Stage	HP	GV1
	2 Stages	HP	GV1@High
2 Gas Valves	1 Stage	HP	GV1 + GV2
	2 Stages	HP	GV1@High + GV2@High

HP = Heat Pump; GV1 = Gas Valve 1; GV2 = Gas Valve 2

Table 20. Room Sensor Mode Operation - Dual Fuel

Gas Valve Equipment		H1 Demand	H2 Demand	H3 Demand
1 Gas Valve	1 Stage	HP	GV1	N/A
	2 Stages	HP	GV1@Low	GV1@High
2 Gas Valves	1 Stage	HP	GV1 + GV2	N/A
	2 Stages	HP	GV1@Low + GV2@Low	GV1@High + GV2@High

HP = Heat Pump; GV1 = Gas Valve 1; GV2 = Gas Valve 2

6.1.2.4. Enlight Heat Pump and Dual Fuel (LHT/LDT) During Heat Pump Lockout

When mechanical heating is locked-out because the outdoor air temperature is below parameter 526/527/528, or for other reasons, the secondary heat source will be activated instead. Electric and Gas staging is identical in this case, and the heat section or gas valve is denoted in these tables as HS.

Table 21. Thermostat Mode Operation (Default) During Heat Pump Lockout - LHT/LDT

Heat Equipment		W1 Demand	W2 Demand
None	N/A	No Heat	N/A
1 Section	1 Stage	HS1	HS1
	2 Stages	HS1@Low	HS1@High
2 Sections	1 Stage	HS1 + HS2	HS1 + HS2
	2 Stages	HS1@Low + HS2@Low	HS1@High + HS2@High

HP = Heat Pump; HS1 = Electric/Gas Heat Section 1; HS2 = Electric/Gas Heat Section 2

Table 22. Room Sensor Mode Operation During Heat Pump Lockout - LHT/LDT

Heat Equipment		H1 Demand	H2 Demand	H3 Demand
None	N/A	No Heat	N/A	N/A
1 Section	1 Stage	HS1	HS1	N/A
	2 Stages	HS1@Low	HS1@High	HS1@High
2 Sections	1 Stage	HS1 + HS2	HS1 + HS2	N/A
	2 Stages	HS1@Low + HS2@Low	HS1@High + HS2@High	HS1@High + HS2@High

HP = Heat Pump; HS1 = Electric/Gas Heat Section 1; HS2 = Electric/Gas Heat Section 2

6.1.2.5. Strategos Heat Pump (SHH)

Table 23. Thermostat Mode Operation 2-Stg (Default) - Heat Pump w/Electric Heat

Electric Heat Equipment			W1 Demand	W2 Demand
None			HP	HP
1 Section	Emergency Heat	1 Stage	HP	HP
		2 Stages	Not Available	
	Auxiliary Heat	1 Stage	HP	HP+ES1
		2 Stages	HP	HP+ES1@High
2 Sections	Emergency Heat	1 Stage	HP	HP
		2 Stages	Not Available	
	Auxiliary Heat	1 Stage	HP	HP+ES1+ES2
		2 Stages	HP	HP+ES1@High+ES2@High

HP = Heat Pump; ES1 = Electric Heat Section 1; ES2 = Electric Heat Section 2

Table 24. Thermostat Mode Operation 3-Stg - Heat Pump w/Electric Heat

Electric Heat Equipment			W1 Demand	W2 Demand	W3 Demand
None			HP	HP	HP
1 Section	Emergency Heat	1 Stage	HP	HP	HP
		2 Stages	Not Available		
	Auxiliary Heat	1 Stage	HP	HP+ES1	HP+ES1
		2 Stages	HP	HP+ES1@Low	HP+ES1@High
2 Sections	Emergency Heat	1 Stage	HP	HP	HP
		2 Stages	Not Available		
	Auxiliary Heat	1 Stage	HP	HP+ES1+ES2	HP+ES1+ES2
		2 Stages	HP	HP+ES1@Low+ES2@Low	HP+ES1@High+ES2@High

HP = Heat Pump; ES1 = Electric Heat Section 1; ES2 = Electric Heat Section 2

6.1.2.6. Strategos Heat Pump (SHH) During Heat Pump Lockout

Table 25. Thermostat Mode Operation 2-Stg (Default During Heat Pump Lockout) - Heat Pump w/Electric Heat

Electric Heat Equipment			W1 Demand	W2 Demand
None			No Heat	
1 Section	Emergency Heat	1 Stage	ES1	ES1
		2 Stages	Not Available	
	Auxiliary Heat	1 Stage	ES1	ES1
		2 Stages	ES1@Low	ES1@High

HP = Heat Pump; ES1 = Electric Heat Section 1; ES2 = Electric Heat Section 2

Electric Heat Equipment			W1 Demand	W2 Demand
2 Sections	Emergency Heat	1 Stage	ES1+ES2	ES1+ES2
		2 Stages	Not Available	
	Auxiliary Heat	1 Stage	ES1+ES2	ES1+ES2
		2 Stages	ES1@Low+ES2@Low	ES1@High+ES2@High

HP = Heat Pump; ES1 = Electric Heat Section 1; ES2 = Electric Heat Section 2

Table 26. Thermostat Mode Operation 3-Stg (During Heat Pump Lockout) - Heat Pump w/Electric Heat

Electric Heat Equipment			W1 Demand	W2 Demand	W3 Demand
None			No Heat		
1 Section	Emergency Heat	1 Stage	ES1	ES1	ES1
		2 Stages	Not Available		
	Auxiliary Heat	1 Stage	ES1	ES1	ES1
		2 Stages	ES1@Low	ES1@High	ES1@High
2 Sections	Emergency Heat	1 Stage	ES1+ES2	ES1+ES2	ES1+ES2
		2 Stages	Not Available		
	Auxiliary Heat	1 Stage	ES1+ES2	ES1+ES2	ES1+ES2
		2 Stages	ES1@Low+ES2@Low	ES1@High+ES2@High	ES1@High+ES2@High

HP = Heat Pump; ES1 = Electric Heat Section 1; ES2 = Electric Heat Section 2

6.1.2.7. Strategos Dual Fuel (SDH)

Table 27. Thermostat Mode Operation 2-Stg - (Default) - Dual Fuel

Gas Valve Equipment		W1 Demand	W2 Demand
1 Gas Valve	2 Stages	HP	GV1@High
2 Gas Valves	2 Stages	HP	GV1@High+GV2@High

HP = Heat Pump; GV1 = Gas Valve 1; GV2 = Gas Valve 2

Table 28. Thermostat Mode Operation 3-Stg - Dual Fuel

Gas Valve Equipment		W1 Demand	W2 Demand	W3 Demand
1 Gas Valve	2 Stages	HP	HP	GV1@High
2 Gas Valves	2 Stages	HP	HP	GV1@High+GV2@High

HP = Heat Pump; GV1 = Gas Valve 1; GV2 = Gas Valve 2

6.1.2.8. Strategos Heat Pump (SDH) During Heat Pump Lockout

Table 29. Thermostat Mode Operation 2-Stg (Default) - Dual Fuel

Gas Valve Equipment		W1 Demand	W2 Demand
1 Gas Valve	2 Stages	GV1@Low	GV1@High
2 Gas Valves	2 Stages	GV1@Low+GV2@Low	GV1@High+GV2@High

HP = Heat Pump; GV1 = Gas Valve 1; GV2 = Gas Valve 2

Table 30. Thermostat Mode Operation 3-Stg - Dual Fuel

Gas Valve Equipment		W1 Demand	W2 Demand	W3 Demand
1 Gas Valve	2 Stages	GV1@Low	GV1@High	GV1@High
2 Gas Valves	2 Stages	GV1@Low+GV2@Low	GV1@High+GV2@High	GV1@High+GV2@High

HP = Heat Pump; GV1 = Gas Valve 1; GV2 = Gas Valve 2

6.2. System Mode - Room Sensor

The Room Sensor Mode allows the M4 unit controller to use internal setpoints and input from a room sensor or the unit return air sensor to operate the unit. An additional thermostat or energy management system is not required but can also provide setpoints to the system.

Options for Room Sensor include:

- RTU Standalone: The unit can operate with a room sensor without a building automation system. Setpoints are set using the CORE Service App.
- BACnet: The unit can operate with a BACnet automation system (either IP or MS/TP).
- LonTalk: The unit can operate with a LonTalk building automation system.

Go to RTU MENU > SETUP > INSTALL > (select) RTU DATE AND TIME > RTU INFORMATION > CONFIGURATION ID 1

NOTE: To select LonTalk, Configuration ID 1, position 5 needs to be set to L.

- L-Connection: The unit will operate with a Network Control Panel (NCP) or standalone with a CS8500 Network Sensor.

The room sensor is wired directly to each unit P298-6 and P298-7 (marked GND and TMP on the Field Wiring Termination Plugs). The room sensor wiring diagram key number is A2. Sensor values can also be sent from the network in lieu of a physical sensor. Sensor values must be sent regularly to the controller.

6.3. Room Sensor Primary Modes:

Use the CORE Service App setup wizard to configure a primary mode option. This is not needed in standalone operation.

Go to RTU MENU > SETUP > NETWORK INTEGRATION > NETWORK SETUP WIZARD

NOTE: Select the appropriate menu option to determine the room sensor primary mode. The following options are available:

- MONITOR ONLY allows the L-Connection, BACnet, or LonTalk system to monitor system details while a conventional thermostat controls operation of the unit.
- ROOM SENSOR is the typical room sensor operational mode when operating with a building automation system as the main control system, using setpoints to determine demand.
- NETWORK THERMOSTAT is available for L-Connection and BACnet systems. Network thermostat allows control of the unit with thermostat commands that are sent over the network system instead of setpoint control.

6.3.1. Room Sensor Back-up Modes

Use the CORE Service App setup wizard to configure a back-up mode option.

Go to RTU MENU > SETUP > NETWORK INTEGRATION > NETWORK SETUP WIZARD

NOTE: Select the appropriate menu option to determine the room sensor back-up mode. The back-up mode is used in the event that the A2 room sensor fails or is disconnected. The following options are available:

- **NONE** has no back-up mode of control should the A2 room sensor fail.
- **ROOM SENSOR** option is only available if the control mode is set to NETWORK THERMOSTAT.
- **RETURN AIR BACKUP** will default to return air sensor RT16 (should the A2 room sensor fail). The M4 unit controller will switch over and operate based on the temperature from the return air sensor. RT16 is standard on all units; therefore, M4 unit controller return air backup is the recommended backup mode when units are setup in the room sensor mode.
- **THERMOSTAT** will default to a local thermostat if one is installed (should the A2 room sensor fail). The M4 unit controller will switch over and operate based on the signals from the room thermostat.

NOTE: The RT16 sensor has a lower resolution than the A2 room sensor and should only be used as back-up.

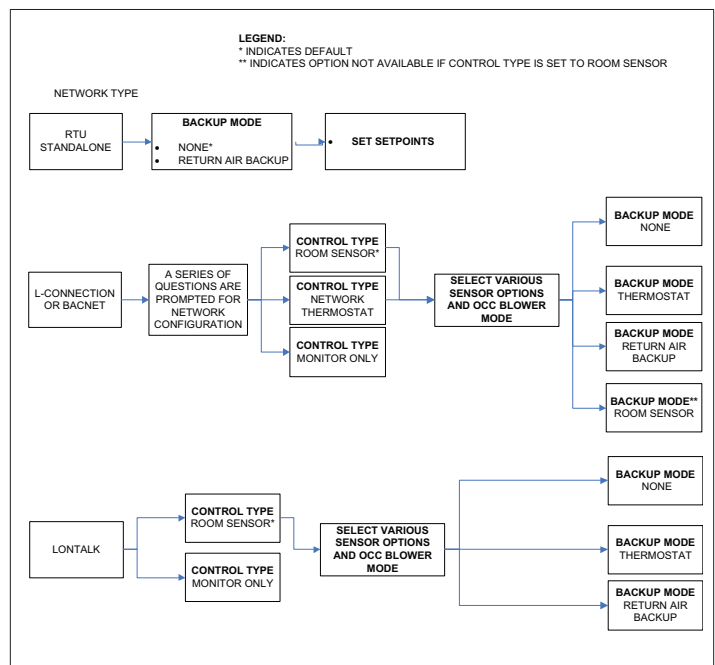


Figure 32. Backup Mode

6.3.2. Room Sensor Back-Up Mode Set Points

Using the CORE Service App, the following setpoints are available when primary mode is set to NETWORK THERMOSTAT and the backup sensor mode is set to either RETURN AIR BACKUP or ROOM SENSOR. All available setpoints have a range of 40.0°F to 95.0°F (4.4°C to 35°C).

The listed values below are defaults.

- Occupied Heating setpoint: 70.0°F (21°C)
- Unoccupied Heating setpoint: 60.0°F (15.5°C)
- Occupied Cooling setpoint: 75.0°F (23.8°C)
- Unoccupied Cooling setpoint: 85.0°F (29.4°C)

Use Parameters 142 and 151 for stage differential and dead-band options to adjust setpoints in room sensor mode.

6.3.3. L Connection Network Back-Up Mode

Use the CORE Service App setup wizard to configure a back-up mode option. The following references the wizard path to the backup mode setting.

Go to RTU MENU > SETUP > NETWORK INTEGRATION > NETWORK SETUP WIZARD

Back-up mode option is used when the communication link has been lost on the L Connection® system bus. Five minutes after communication is interrupted, the M4 unit controller will start using the configured back-up mode and applicable setpoints. The M4 unit controller will default to back-up setpoints for occupied heat or cool modes.

During normal room sensor operation with a network control panel, the occupied demands are sent over the network and the occupied input on P297-8 is ignored. The occupied input on P297-8 is only read if the network communication link is lost and the backup mode is set to local thermostat.

The Room Sensor Mode will default to **Occupied**. If communication is lost the system will remain in the last state it received until communication is restored or power is cycled.

After the delays, the units will go to an **Occupied Back-up** mode regardless of any input at P297-8, which will be ignored.

6.3.4. Heating and Cooling Stages in Room Sensor Mode

In Room Sensor Mode default operation, the M4 unit controller controls up to four stages of heating and cooling. See “Figure 33. Room Sensor Stages for Gas / Electric Units - Heating (default values shown)” on page 40 and “Table 77. CORE Control System Unit Parameters” on page 140.

On units with economizers, outside air is used for free cooling. One or more compressors may be turned on during free cooling to meet demand if the zone air temperature is far from setpoint (i.e. the blower PI control loop error is large).

6.3.4.1. Model L LCM/LGM Sizes -036U through -074U

Three through six ton units feature a fully variable compressor, indoor blower, and outdoor fan. For cooling, the M4 unit controller actively monitors space temperature from the room sensor and discharge air temperature.

Based on this information, the M4 unit controller modulates the indoor blower to meet the space temperature setpoint and modulates the compressor to meet the discharge air temperature setpoint.

The outdoor fan is controlled based on compressor speed. In this way, the unit controller uses only the capacity needed to meet the space temperature and discharge air temperature setpoints, which improves unit efficiency, reliability, and comfort.

Due to the variability of the compressor and indoor blower, there are infinitely many stages of cooling depending on the setpoints and load in the space, which differs from traditional commercial rooftop HVAC units that have fixed stages of cooling. The unit controller will cease unit operation in cooling mode after the cooling demand in the space has been satisfied.

If the outdoor air is suitable and the unit features an economizer, instead of using mechanical cooling to meet a low cooling demand, the M4 unit controller will try to meet the demand by opening the economizer and using outdoor air. The economizer damper will modulate to maintain Parameter 159 setting (supply air temperature) and satisfy the cooling demand.

If the unit is unable to satisfy the cooling demand using outdoor air, then the unit will react to the high cooling demand by initiating mechanical cooling while keeping the economizer at the fully open position. The unit controller will modulate mechanical cooling capacity based on the cooling load until the cooling demand has been satisfied.

6.3.4.2. Model L LCM/LGM sizes -092U through -300U

Ultra-High efficiency models with multiple compressors have a single variable-speed compressor and one or more fixed-speed compressors.

The behavior is the same as described above for the single compressor units except that a combination of fixed and variable speed compressors are used to provide continuously variable mechanical cooling across the tonnage range of the unit.

6.3.4.3. Strategos HP SHH/SDH Sizes -036U through -120U

Three through ten ton Strategos Ultra-High efficiency heat pump units feature a single fully variable compressor, indoor blower, and outdoor fans. For mechanical cooling and heating, the M4 unit controller actively monitors space temperature from the room sensor and discharge air temperature.

Based on this information, the M4 unit controller modulates the indoor blower to meet the space temperature setpoint and modulates the compressor to meet the discharge air temperature setpoint.

The outdoor fans are controlled based on compressor speed. In this way, the unit controller uses only the capacity needed to meet the space temperature and discharge air temperature setpoints, which improves unit efficiency, reliability, and comfort.

Due to the variability of the compressor and indoor blower, there are infinitely many stages of mechanical cooling or heating depending on the setpoints and load in the space, which differs from traditional commercial rooftop HVAC units that have fixed stages of mechanical cooling and heating. The unit controller will cease unit operation after the cooling or heating demand in the space has been satisfied.

If the outdoor air is suitable and the unit features an economizer, instead of using mechanical cooling to meet a low cooling demand, the M4 unit controller will try to meet the demand by opening the economizer and using outdoor air. The economizer damper will modulate to maintain Parameter 159 setting (supply air temperature) and satisfy the cooling demand.

If the unit is unable to satisfy the cooling demand using outdoor air, then the unit will react to the high cooling demand by initiating mechanical cooling while keeping the economizer at the fully open position. The unit controller will modulate mechanical cooling capacity based on the cooling load until the cooling demand has been satisfied.

6.3.4.4. Strategos HP SHH/SDH Sizes -180U through -240U

Fifteen and 20 ton Strategos Ultra-High efficiency heat pump units feature two variable-speed compressors.

The behavior is similar to what is described above for the single compressor units except that a second compressor may be staged up or down to meet the cooling or heating demand. Also a second blower is used to meet the airflow demand. After an initial startup period for each compressor, both compressors modulate at the same RPM to provide continuously variable mechanical cooling and heating across the tonnage range of the unit. The two blowers always run at the same speed.

6.3.4.5. Start-up Delay in Room Sensor Mode

In Room Sensor Mode, the M4 unit controller initiates a start up delay on any power-up or reboot (two minute default). During the delay, no blower, heating, or cooling operation will occur. This delay may be adjusted using Parameter 133 to stagger the start of each unit, reducing the initial power demand. Adjustable range is 2 to 30 minutes.

Go to RTU MENU > SETTINGS > RTU OPTION > EDIT PARAMETER = 133 (ZONE SENS STRTUP DLY)

6.3.4.6. Blower Operation (Occupied) in Room Sensor Mode

In Room Sensor Mode (default operation) the M4 unit controller cycles the blower with a heat/cool demand. The menu path as listed in table 9 on page 11 will allow a change to continuous blower operation. The following are the OCC (OCCUPIED) blower mode description:

- **AUTO CYCLE:** Blower cycles with demand.
- **ON-CONTINUOUS 1:** Blower is on when either the occupancy sensor or occupancy scheduler indicate occupied.
- **ON-CONTINUOUS 2:** Blower is on only WHEN BOTH the occupancy sensor and occupancy scheduler indicate occupied.
- **ON-CONTINUOUS 3:** Blower is only on when both the occupancy sensor and occupancy scheduler indicates occupied. Blower will be on a minimum of 25% of the time when occupancy scheduler indicates occupied but the occupancy sensor indicates not occupied. The 25% minimum is achieved by turning blower on for 30 minutes and off for 90 minutes.

6.3.4.7. Room Sensor Parameters (LCM/LGM Model L Ultra-High Efficiency and SHH/SDH Strategos Heat Pump Units)

Any of the parameters listed can be directly modified using the following method:

Heating

Go to RTU MENU > SETTINGS > RTU OPTION > EDIT PARAMETER = (see Parameters 137 - 152)

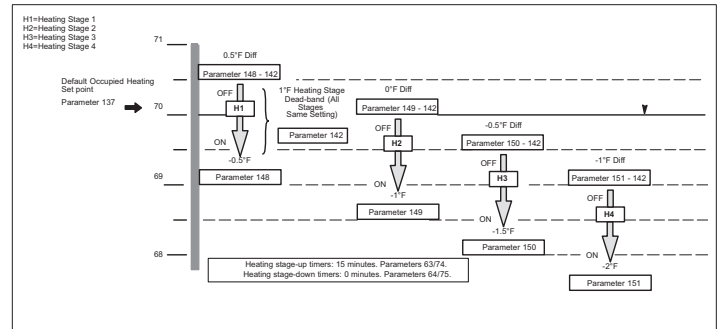


Figure 33. Room Sensor Stages for Gas / Electric Units - Heating (default values shown)

For Strategos Heat Pump units

The output of the variable-speed compressor (C1) modulates to maintain the discharge air temperature set in parameter 629 with a default setting of 95°F (35°C).

For multi-compressor units

The controller will add or remove additional variable-speed compressors (C2) as needed to maintain DAT. Both compressors when energized run at the same speed to provide efficient mechanical heating operation.

- SHH units: For Non-Emergency units, Auxiliary heating is energized in addition to mechanical heating if needed to satisfy a demand. For Emergency units, mechanical heating and auxiliary heating won't be energized at the same time.
- SDH units: Gas heat is energized under suitable conditions if needed to satisfy a demand. Gas heating and mechanical heating won't be energized at the same time.

Cooling

For Model-L units

The output of the variable-speed compressor (C1) modulates to maintain the discharge air temperature set in parameter 375 with a default setting of 55°F (12.7°C).

For multi-compressor units

The controller will add or remove additional fixed speed compressors (C2-4) as needed to maintain DAT according to the thresholds shown in "Figure 34. Room Sensor Stages for

Gas / Electric Units - Cooling (default values shown)

When staging up or down, the variable-speed compressor will be lowered or raised in speed accordingly to provide a smooth transition in the amount of mechanical cooling delivered.

The on/off thresholds are controlled by parameters 444 and 445. The staging up or down may be delayed by a variety of factors (compressor minimum run/off times, stage minimum run time, cooling state changes, variable compressor rate, DAT settling time, etc.)

For Strategos Heat Pump units

The output of the variable-speed compressor (C1) modulates to maintain the discharge air temperature set in parameter 375 with a default setting of 55°F (12.7°C).

For multi-compressor units

The controller will add or remove additional variable-speed compressors (C2) as needed to maintain DAT. Both compressors when energized run at the same speed to provide efficient cooling operation.

The on/off thresholds are controlled by parameters 444 and 445. The staging up or down may be delayed by a variety of factors (compressor minimum run/off times, stage minimum run time, cooling state changes, variable compressor rate, DAT settling time, etc.)

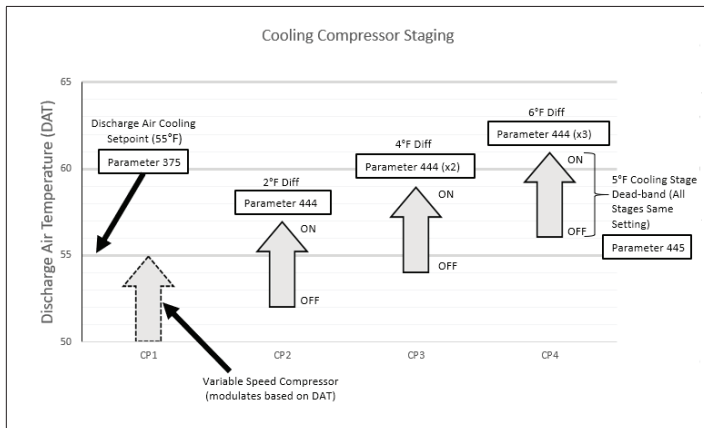


Figure 34. Room Sensor Stages for Gas / Electric Units - Cooling (default values shown)

6.3.4.8. Room Sensor Parameters (LGT/LCT/LHT/LDT/SCH/SGH Enlight and Strategos High Efficiency Units)

Any of the parameters listed can be directly modified using the following method:

Go to SETTINGS > RTU OPTION > EDIT PARAMETER = (see Parameters 63, 64, 74, 75, 101 - 104, 133, 137 - 152, 534 & 535)

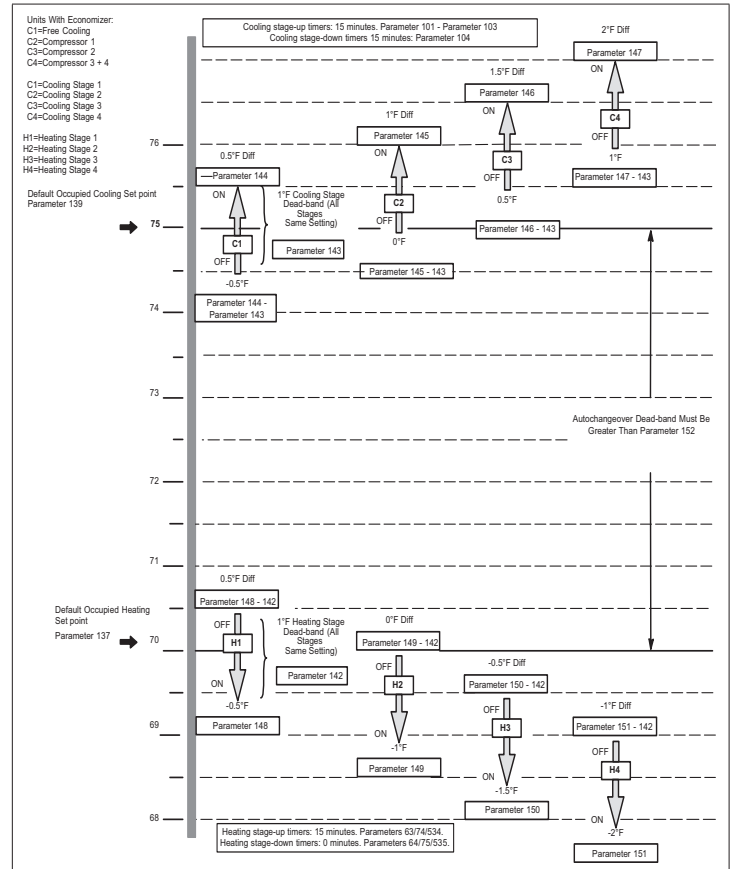


Figure 35. Room Sensor Stages for Gas / Electric Units (default values shown)

7. Lennox® Low GWP Refrigerant Detection System (RDS)

The CORE controller incorporates a refrigerant detection system (RDS) to ensure safe operation of Lennox commercial HVAC systems that employ low GWP (Global Warming Potential) refrigerant. This system is required for all systems using R-454B refrigerant.

The RDS provides refrigerant dispersion and operator notification in the event of a refrigerant leak. When a refrigerant leak is detected, the controller turns on devices that can disperse the refrigerant and lower its concentration within the unit's cabinet.

The RDS is active during normal operation and is not active during modes where the RTU is being serviced or configured to prevent equipment from turning on or off unexpectedly when a technician is present.

After power-up, the sensors used in the RDS have a 30-second warm-up period before HVAC demands can be serviced.

7.1. Sensors

The system supports up to two (2) refrigerant detection sensors placed at various locations in the RTU. The number and placement of these sensors is determined by the model and cannot be changed. If an RTU requires sensors to be installed and they are not present or not functional, the RTU will operate with blower and outdoor fans on until the sensor(s) are replaced.

Sensors can only be replaced with Lennox-approved replacement parts.

7.2. Alarms

The system uses existing alarm reporting features to alert the operator of a refrigerant leak or faulty sensor(s).

Refrigerant Sensor No.	1	2
Area	Indoor	Control Panel/ Compressor
Leaked Detected by Sensor	Alarm 152	Alarm 153
Sensor Faulty or Missing	Alarm 257	Alarm 258

In addition, there is a dedicated dry contact relay that can be connected to a customer-supplied audible alarm to alert the operator of a leak or faulty sensor. The relay is closed when a leak is detected. If a sensor is faulty or missing, the relay may be configured to close for five (5) seconds. This five (5) second closure for non-leak events can be enabled or disabled via Parameter 543.

7.3. Mitigation Actions

7.3.1. Actions on a Refrigerant Leak

In the event of a refrigerant leak the following mitigation actions are taken:

Step 1.	Blower, outdoor fan(s), and combustion air blower (if present) are turned on to disperse and dilute the leaked refrigerant.
Step 2.	Compressor, gas heat, and electric heat are turned off. Free-cooling is allowed to operate.

In VAV applications, the blower runs to maintain a configurable duct static pressure specifically for RDS mitigation (Parameter 541).

7.3.2. Actions on a Faulty or Missing Sensor

In the event of a faulty or missing sensor, the following preventative actions are taken:

Step 1.	Blower and fan run continuously to disperse refrigerant regardless of demand.
Step 2.	If positive blower proof* can be established, cooling and heating demands are serviced.
* Blower proof is required for all models using R-454B refrigerant. Blower proof is determined from either a physical blower proving switch or via RPM feedback (MODBUS or 0-5V PWM signal) depending on the model.	

In VAV applications, the blower runs to maintain a configurable duct static pressure specifically for RDS mitigation (parameter 541).

7.4. User Test

The operator may test the RDS response via the component test menu. This operation simulates a leak condition and allows the operator to verify the mitigation actions described in the preceding section.

7.5. Sensor Placement

	Model	# of Sensors	Sensor 1 (Indoor)	Sensor 2 (Control Panel/ Compressor)
Model L (A Box)	LGM	2	Y	Y
Model L (A Box)	LCM	1	Y	NA
Model L (B Box)	LGM/LCM	1	Y	NA
Model L (C Box)	LGM/LCM	2	Y	Y
Enlight (A Box)	LGT/LDT	2	Y	Y
Enlight (A Box)	LCT/LHT	1	Y	NA
Enlight (B Box)	LGT/LCT/LHT/LDT	1	Y	NA
Enlight (C Box)	LGT/LCT/LHT/LDT	2	Y	Y
Enlight (D Box)	LGT/LCT/LHT/LDT	2	Y	Y
Strategos (A Box)	SGH/SDH	2	Y	Y
Strategos (A Box)	SCH/SHH	1	Y	NA
Strategos (B Box)	SGH/SDH	2	Y	Y
Strategos (B Box)	SCH/SHH	1	Y	NA
Strategos (D Box)	SCH/SGH/SHH/SDH	2	Y	Y

8. Unit Component Operation - Protection, Delays, and Switches

8.1. Compressor Protection and Delays

If Parameter 89 is set with a minimum off delay and there is a new demand, the M4 unit controller display will indicate the demand is active (i.e., cooling). However, the compressor(s) will not come on until the delay time specified has been met.

8.1.1. Compressor Minimum Run-Time Off-Delay

Model L Ultra-High Efficiency Units will always have both compressor Minimum Run-Time (default 240 seconds) and Minimum Off-Delay (default 300 second) enabled. This method cannot be altered. However, parameter time settings can be adjusted. Enlight and Strategos units apply either a compressor Minimum Run Time or Minimum Off Delay depending on line voltage.

Go to RTU MENU > SETTINGS > RTU OPTION > EDIT PARAMETER = 91 (COMP MIN RUN TIME)

Go to RTU MENU > SETTINGS > RTU OPTION > EDIT PARAMETER = 89 (COMP MIN OFF DELAY)

8.1.2. Freezestat

Model L, Enlight, and Strategos (non-heat pump) units employ temperature sensors attached to the evaporator coils to determine coil temperature. Strategos heat pump units calculate an evaporator coil temperature from suction pressure transducer measurements.

For frozen coil detection the controller monitors the Saturated Suction Temperature sensor (or Suction Pressure for Strategos heat pump units) for each compressor circuit.

When an evaporator coil temperature approaches freezing, the corresponding compressor is de-energized. After the coil temperature rises, the controller allows compressor operation.

The corresponding compressor is locked out after three occurrences (default) during a single demand cycle (mechanical cooling only), which is set using Parameter 81. The adjustable range is one (1) to three (3) occurrences.

When a compressor is de-energized due to a detected freeze condition, Alarm 32 (compressor circuit 1), 34 (circuit 2), 36 (circuit 3) or 38 (circuit 4) is issued.

When a compressor is locked out due to a detected freeze condition, Alarm 33 (circuit 1), Alarm 35 (circuit 2), Alarm 37(circuit 3), Alarm 39 (circuit 4) are issued.

NOTE: No alarms are recorded during off cycles between cooling calls. In addition, even if Parameter 81 is set to an alternate occurrence number, the alarm itself will always indicate three strikes.

NOTE: Freezestat alarms will not indicate an OFF ON ALARM state.

NOTE: (Model L and Strategos Heat Pump Units only) Freezestat detection is momentarily paused during certain conditions that may cause temporary fluctuations in the coil temperature (staging up compressors, cooling state changes, etc.).

Go to RTU MENU > SETTINGS > RTU OPTION > EDIT PARAMETER = 81 (MAX FREEZE STAT OCC)

8.1.3. Thermal Protection Switches

NOTE: Not all models use all of the referenced switches. Verify with unit wiring diagram to confirm switch(es) used. Also refer the unit installation instruction for switches used and operation.

Thermal protection switches open on a temperature rise to de-energize the corresponding compressor. Switches automatically reset when temperature drops. The corresponding compressor is locked out after three occurrences (default) of either high pressure or high temperature conditions during a demand cycle. The number of occurrences can be changed using Parameter 98. Adjustable range is one (1) to seven (7) occurrences.

On certain compressors, these switches are in series with the high pressure switches, and will cause a 300 second delay (default), which is set using Parameter 110. This will also set off an alarm. Adjustable delay range is 64 to 1800 seconds.

Go to RTU MENU > SETTINGS > RTU OPTION > EDIT PARAMETER = 98 (MAX HP OCCURRENCES)

Go to RTU MENU > SETTINGS > RTU OPTION > EDIT PARAMETER = 110 (ERR TIME OFF DELAY)

8.1.4. High Pressure Switches

- High pressure switches open on a pressure rise to de-energize the corresponding compressor for 300 seconds (default), which is set using Parameter 110.
- High pressure switches automatically reset when pressure drops.

The corresponding compressor is locked out after three occurrences (default), which is set using Parameter 98. Adjustable range is one (1) to seven (7) occurrences. When a compressor is de-energized due to an open high pressure switch, Alarm 12 (S4 switch), 14 (S7 switch), 16 (S28 switch) or 18 (S96) is issued.

NOTE: (Model L units only) The S4 switch is connected to the variable speed compressor inverter power, rather than the compressor itself. Disconnecting S4 will prevent the inverter drive from operating.

NOTE: The outdoor fan on 3 to 6 ton models continue to run even after a high pressure switch trip.

NOTE: Outdoor fans continue to run after a high pressure switch trip for all Enlight and Strategos GE/EE models.

NOTE: Only the displayed alarm(s) will indicate that the applicable compressor has been de-energized. The system status on the display will only indicate the current demand type in this scenario.

NOTE: High pressure switch alarms will not indicate an OFF / ON ALARM state.

The corresponding compressor is locked out after three occurrences (default), which is set using Parameter 98.

Go to RTU MENU > SETTINGS > RTU OPTION > EDIT PARAMETER = 98 (MAX HP OCCURRENCES)

8.1.5. Low Pressure Switches (S87, S88, S97, and S98)

Depending on the model, one to four low pressure switches may be employed. Refer to the unit installation instruction or wiring diagram to verify the number of switches.

Low pressure switches may trip during lower outdoor temperatures, especially with longer time periods between compressor cycling. Each compressor stage has low pressure switch protection which:

- De-energizes the compressor for five minutes (default) if the low pressure switch trips.
- The controller will ignore the low pressure switch for a specified period of time after thermostat demand.
- The specified ignore time period can be adjusted using Parameter 100. Default is 120 seconds. Setting range is 0 to 600 seconds.
- The default ignore time period is 90 seconds if the compressor starts to run for the heat pump heat demand.

Go to RTU MENU > SETTINGS > RTU OPTION > EDIT PARAMETER = 100 (LP SW IGNORE TIME)

The controller locks out the compressor stage if the low pressure switch trips three times (default) within the same thermostat demand (after the ignore time period has elapsed).

When a compressor is de-energized due to an open low pressure switch, Alarm 22 (circuit 1), Alarm 24 (circuit 2), Alarm 26 (circuit 3), Alarm 28 (circuit 4) are issued.

When a compressor is locked out due to LP switch trips, Alarm 23 (circuit 1), Alarm 25 (circuit 2), Alarm 27 (circuit 3), Alarm 29 (circuit 4) are issued.

The default setting can be changed by using Parameter 99. The valid number of occurrence range is 1 through 7.

Go to RTU MENU > SETTINGS > RTU OPTION > EDIT PARAMETER = 99 (MAX LP OCCURRENCES)

NOTE: Only the displayed alarm(s) will indicate that the applicable compressor has been de-energized. The system status on the display will only indicate the current demand type in this scenario.

NOTE: Low pressure switch alarms will not indicate an OFF ON ALARM state.

8.1.6. Loss-of-Power Detection

The CORE controller will stop unit operation and shutdown if a loss of power is detected. If power becomes stable or is restored, the CORE Controller will power on and resume operation.

Go to RTU MENU > SETTINGS > RTU OPTION > EDIT PARAMETER = 110 (ERR TIME OFF DELAY)

8.1.7. Compressor Speed Foldback

Strategos Heat Pump units employ pressure sensors that monitor high-side and low-side pressures. When those pressure values go beyond a threshold, the variable-speed compressor(s) reduces its speed to protect the compressor. Under certain conditions, the controller can de-energize the compressor to protect it and raise the corresponding alarm. Similar safety features are available using compressor discharge temperature and compressor current consumption. The controller resumes compressor operation when the above-mentioned parameters read nominal values.

8.2. Gas Units Burner Protection and Delays

The S10, S18, S21, S45, S47, S69, S99, and S100 switches are built into direct spark ignition (DSI) control board. The DSI board must manually reboot in order to reset the aforementioned switches.

8.2.1. Primary or Secondary Limits (S10 and S99)

If primary or secondary limits open during heating, the M4 unit controller will de-energize the gas valve and energize the blower. If primary or secondary limits open three times during a thermostat cycle, the heat section operation will lock out for one hour.

8.2.2. Flame Roll-Out Switches (S47 and S69)

If the roll-out switch opens, the gas valve will de-energize and a manual reset of the flame roll-out (ROL) switch is required to restart.

8.2.3. Combustion Air Inducer (CAI) Proof Switches (S18 and S45)

8.2.3.1. Open Proof Sequence of Operations

- The M4 unit controller will set Alarm 166 or 167 (or both) if either S18 or S45 are not proved open while the combustion air blower is not energized. If gas heat demand is still present, the M4 unit controller will attempt to prove either S18 or S45 are in an open condition every 60 seconds.
- If either S18 or S45 are proven as open, the M4 unit controller will proceed with the gas heat demand (i.e., energize the combustion air blower).
- Even while lockout Alarm(s) 168 and/or 169 are active, the M4 unit controller will continue attempting if either S18 or S45 are open. Parameter 72 - Max CAI No Open Proof Occurrences default setting is 5 and it is adjustable from 1 to 15 occurrences.
- The M4 unit controller will set Alarm(s) 168 or 169 (or both) (instead of 166/167) if either S18 or S45 are not proved open while the combustion air blower is not energized, for 5 consecutive times during a single cycle. Even while Alarm(s) 168 and/or 169 are active, the M4 unit controller will continue attempting to prove that either S18 and/or S45 are open.

Go to RTU MENU > SETTINGS > RTU OPTION > EDIT PARAMETER = 72 (MAX CAI NO PRF OCC)

8.2.3.2. Open Proof Alarms

Open proof alarms are 166 through 169.

8.2.3.3. Closed Proof Sequence of Operations

- a. The M4 unit controller will set an alarm(s) (Alarm 56 or 66) if either:
 - S18 or S45 switches are not sensed as closed within 30 seconds of energizing the combustion air inducer.
 - S18 or S45 switches are sensed as open for three seconds while gas heat demand is active.
- b. The M4 unit controller will set an alarm(s) 57 and/or 67 when three-strikes occur during a single-demand. Parameter 71 default setting is 3 and is adjustable from one (1) to five (5) occurrences. To view or change the number of occurrences setting:

Go to RTU MENU > SETTINGS > RTU OPTION > EDIT PARAMETER = 71 (MAX CAI NO SW OCC).

NOTE: In addition, even if Parameter 71 is set to an alternate occurrence number, the alarm itself will indicate three strikes.

8.2.3.4. Closed Proof Alarms

Closed proof alarms are 56, 57, 66, and 67.

8.2.4. Gas Valve Sensor Activation Feedback

If M4 unit controller does not detect that gas valve is energized within two minutes after a heating demand, it will

display and store error code 58 for gas heat section 1 and Alarm 68 for gas heat section 2.

If the gas valve is energized and de-energized three times (default) during a single heating demand, the M4 will display and store error code 59 for the gas heat section 1 and Alarm 60 for gas heat section 2.

The service relay activates if configured.

The default setting for Parameter 73 is three occurrences with a valid range setting of 1 to 5.

Go to RTU MENU > SETTINGS > RTU OPTION > EDIT PARAMETER = 73 (MAX GV SENSE OCC)

If the gas valve is energized without a heating demand the M4 unit controller will de-energize all heat control outputs. The Service Output turns off if it is configured for alarm reporting (default setting).

8.2.5. Gas Heat Valve Delays

The M4 unit controller has a model dependent time delay setting (Parameter 69 - HT GAS HI FIRE DLAY) between first and second stages. Configurable delay options for Parameter 69 are 30 to 300 seconds.

Parameter 70 - HT GAS OFF DELAY provides timed-off delay that prevents gas heat operation until 100 seconds (factory default) has passed from the previous cycle. Configurable delay options for Parameter 70 are 30 to 300 seconds.

Go to RTU MENU > SETTINGS > RTU OPTION > EDIT PARAMETER = 70 (HT GAS OFF DELAY)

8.3. Miscellaneous Components

8.3.1. Thermostat Bounce Delay (Wired Thermostat Mode Only)

The M4 unit controller automatically ignores wired thermostat inputs for three seconds to prevent sporadic on/off cycling. The function is non-adjustable.

8.3.2. Return Air Temperature Limits

The M4 unit controller may be set up to monitor return air temperature and interrupt the demand if return temperature is above (in heating) or below (in cooling) adjustable limits. Alarm codes 40 or 41 are displayed, but are not stored in memory for recall.

- Adjusting Parameter 113 enables return air temperature limits. Default is 2 (Heating). Options are 0 = Disabled, 1 = Cooling RAT Limit, 2 = Heating RAT Limit and 3 = Cooling and Heating RAT Limit

Go to RTU MENU > SETTINGS > RTU OPTION > EDIT PARAMETER = 113 (EN RET AIR TMP LMT)

- Parameter 114 is used to adjust the cooling limit temperature. Default is 65.0°F. Adjustable range is 60.0°F to 80.0°F.

Go to RTU MENU > SETTINGS > RTU OPTION > EDIT PARAMETER = 114 (COOL RET AIR LIMIT)

- Parameter 115 is used to adjust the heating limit temperature. Default is 85.0°F. Adjustable range is 60.0°F to 100.0°F.

Go to RTU MENU > SETTINGS > RTU OPTION > EDIT PARAMETER = 115 (HEAT RET AIR LIMIT)

Smoke Detector (A171 and A172 - Optional)

A171 is for return air and A172 is for supply air. If the smoke detector senses smoke, normally open contacts close. The M4 unit controller by default turns off the unit and closes the economizer dampers. Variations in damper position, power exhaust, and blower operation may be changed by Parameter 109.

Go to RTU MENU > SETTINGS > RTU OPTION > EDIT PARAMETER = 109 (SMOKE ALARM CONTROL)

Table 31. Smoke Alarm Control

Parameter 109 Option	Blower	Exhaust (1 or 2 Stage)	Exhaust (VFD)	Fresh Air Damper	Description
0	Off	Off	Off	Closed	Unit Off
2	Off	On	Off	Closed	Negative Pressure with blower exhaust fan at fixed speed.
4	Off	Off	On	Closed	Negative Pressure. Exhaust Fan Modulates.
9	On	Off	Off	Open	Positive Pressure.
10	On	On	Off	Closed	Negative Pressure with blower exhaust fan at fixed speed.
11	On	On	Off	Open	Purge - Exhaust fan at fixed speed.
12	On	Off	On	Closed	Negative Pressure with Blower. Exhaust Fan Modulates.
13	On	Off	On	Open	Purge - Exhaust Fan Modulates.

8.3.3. Safety Switch Input (A42-Optional)

The M4 unit controller has 24VAC optional inputs (DI-2 or DI-3), which may be used for additional safety switches (such as a loss of phase protection, or supply duct high pressure limit switch). Wire the safety switch in series with the input.

When the normally closed Safety Switch A42 is open, the M4 unit controller will turn off all outputs and display Alarm 20. After the switch has been physically installed, perform the following procedure to enable safety switch monitoring:

Go to RTU MENU > SETUP > INSTALL > CONFIGURATION ID 2

Position 5 must be set to either 2 or 3 depending on whether A42 is wired on DI-2 or DI-3.

8.3.4. Air Flow Proving Switch (S52 - Optional)

Virtual air flow proving is used on all direct drive blowers that have RPM feedback. When a blower initially starts, if the RPM feedback does not reach 50 rpm within the first 16 seconds, the blower is de-energized and alarm 5 is raised. Virtual blower proving is not manually enabled or disabled. It is enabled automatically on blowers that can support it. If a physical air flow proving switch is used, it will take precedence over the virtual air flow proving.

The air flow switch closes during normal unit operation. If air flow is not established (S52 closed) within 16 seconds of blower start or if the S52 opens at any time after that, the M4 unit controller de-energizes the compressor, gas valves, electric heat, and closes economizer damper. The service alarm output will turn on.

Go to RTU MENU > SETUP > INSTALL > CONFIGURATION ID 2

Position 1 and set to **C** to enable the air flow proving switch monitoring via the M4 Unit controller.

NOTE: The Blower Proving Switch (S52) is not available on 3 to 6 ton LCM/LGM Model L Ultra-High Efficiency units.

If S52 is physically connected to a DDC controller and Configuration ID 2 position 1 is set to **D**, then the M4 unit controller will not monitor S52 using this configuration.

8.3.5. Dirty Filter Switch (S27 - Optional)

The dirty filter switch is open during normal unit operation. A dirty filter closes S27. The M4 unit controller displays and stores the error code and turns on the service alarm output (if configured).

Go to RTU MENU > SETUP > INSTALL > CONFIGURATION ID 2

Position 2 must be set to **C**. This enables the dirty filter switch when installed.

8.3.6. Overflow Switches (S149 / S179 - Optional)

The N.C. overflow switch or switches are connected to the M4 unit controller (A55) in series (when applicable) through a dedicated input at J387-5. When the switch opens, the unit controller de-energizes the compressor. After a five-minute time-out, the unit controller verifies the overflow switch position and restarts the compressor(s) as long as a cooling demand is present (if the switch has closed).

Go to RTU MENU > SETUP > INSTALL > CONFIGURATION ID 2

Position 3 must be set to **Y** to enable the overflow switch, if installed.

NOTE: Overflow switch alarms will not indicate an OFF ON ALARM state.

8.3.7. Blower On-Delay

- For electric heat, the Blower On-Delay is disabled and is not adjustable.
- For gas heat, the blower is delayed 40 seconds (default), which is set using Parameter 66 after the gas valve is energized. The adjustable range is 8 to 60 seconds.

Go to RTU MENU > SETTINGS > RTU OPTION > EDIT PARAMETER = 66 (HT GAS BLR ON DELAY)

- For 3 to 6 ton gas models, the blower on is delayed 20 seconds (default) after the gas valve energizes. This value is fixed and cannot be changed.
- For mechanical heat, the blower is delayed zero seconds (default). This can be modified using Parameter 531. The adjustable range is 0 to 60 seconds.

Go to RTU MENU > SETTINGS > RTU OPTIONS > EDIT PARAMETER = 531 (HT PUMP BL ON DLAY)

- On LH units with a secondary heat source, if both mechanical and electric heat are activated at demand start, the shortest of the two delays will apply.
- For cooling, the blower is delayed zero seconds (default). This can be modified using Parameter 79. The adjustable range is 0 to 60 seconds.

Go to RTU MENU > SETTINGS > RTU OPTION > EDIT PARAMETER = 79 (COOL BLR ON DELAY)

- On 3 to 6 ton (LCM/LGM models), blower on-delay for cooling is disabled and not adjustable.

8.3.8. Blower Off-Delay

- For electric heat, the blower off is delayed 20 seconds (default) from the time the heating call is terminated. The blower delay is adjustable using Parameter 60. The parameter range is 0 to 300 seconds.

Go to RTU MENU > SETTINGS > RTU OPTION > EDIT PARAMETER = 60 (HT ELEC BL OFF DLAY)

- For gas heat, the blower off is delayed 120 seconds (default) from the time the heating call is terminated. The blower delay is adjustable using Parameter 67. The parameter range is 80 to 300 seconds.

Go to RTU MENU > SETTINGS > RTU OPTION > EDIT PARAMETER = 67 (HT GAS BLR OFF DLAY)

- For 3 to 6 ton gas models, the blower off is delayed 180 seconds (default) from the time the heating call is terminated. This value is fixed and cannot be changed.
- For mechanical heat, the blower off is delayed 20 seconds (default). This can be modified using Parameter 532. The adjustable range is 0 to 300 seconds.

Go to RTU MENU > SETTINGS > RTU OPTIONS > EDIT PARAMETER = 532 (HT PUMP BL OFF DLAY)

- On LH units with a secondary heat source, if both mechanical and electric heat are active when demand is terminated, the longer of the two delays will apply.
- For cooling, the blower off is delayed 60 seconds (default) from the time the cooling call is terminated. The blower delay is adjustable using Parameter 80. The parameter range is 0-240 seconds.

Go to RTU MENU > SETTINGS > RTU OPTION > EDIT PARAMETER = 80 (COOL BLR OFF DELAY)

- On 3 to 6 ton (LCM/LGM) models, blower off-delay for cooling is disabled and not adjustable.

8.3.9. Unoccupied or Night Setback Mode

During an unoccupied time period dampers do not operate at minimum position (no minimum ventilation requirements during unoccupied period).

8.3.9.1. Wired Thermostat Mode

The unoccupied time period occurs when there is no input at A55_P297-8.

8.3.9.2. Room Sensor Mode

The occupied time period is controlled by the optional

network control panel when installed. The 24VAC input at unit is ignored while in room sensor mode except during back-up operation.

8.3.10. Gas and Electric Heat Warm-Up Mode (During Occupied Time Period)

Many building codes require a percentage of fresh outdoor air when a conditioned space is occupied. A 24VAC input at unit A55_P297-8 energizes the “occupied” (usually daytime) time period. A field-provided and installed thermostat or energy management system provides the input.

- The first 60 minutes (default) of the first heating demand of the occupied time period is called the warm-up mode.
- During the warm-up mode the M4 unit controller keeps economizer dampers closed to conserve energy (Parameters 58, 65, and 533). Default for each parameter is 3600 seconds. Range setting is 0 to 8160 seconds.

Go to RTU MENU > SETTINGS > RTU OPTION > EDIT PARAMETER = 58 (HT ELEC WARMUP DLAY)

Go to RTU MENU > SETTINGS > RTU OPTION > EDIT PARAMETER = 65 (HT GAS WARMUP DELAY)

Go to RTU MENU > SETTINGS > RTU OPTION > EDIT PARAMETER = 533 (HT PUMP WARMUP DLAY)

- The warm-up mode may be bypassed by going to the user interface and clear delays.

Go to RTU MENU > SERVICE > ADVANCED CONTROL > CLEAR DELAYS = YES or NO

8.3.11. Cool-Down Delay (During Occupied Time Period)

To conserve energy, the M4 unit controller ignores second-stage cooling demand and the economizer opens the first 30 minutes (default) OR one cooling cycle (whichever happens first) when the occupied time period starts. The cool-down delay applies only when outdoor air is suitable for free cooling (Parameter 78).

Go to RTU MENU > SETTINGS > RTU OPTION > EDIT PARAMETER = 78 (COOL DOWN DELAY)

The cool-down delay may be bypassed by going to the user interface and clear delays.

Go to RTU MENU > SERVICE > ADVANCED CONTROL > CLEAR DELAYS

8.4. Gas Heat Operation — Gas Units

The CORE Control System has gas heat output control for up to two gas heat sections with two-stage gas valves.

NOTE: M4 unit controller controls the first heat circuit and C4 controls the second heat circuit.

8.4.1. Heat Speeds

When heating option is set to B, Q, X (10th character in the model number), and 12th character is set to ‘P’ (single phase) the blower speed is as follows:

- W1 - Low Heat Speed
- W2 - High Heat Speed

When heating option is set to any other character, the blower speed is as follows:

- W1 - High Heat Speed
- W2 - High Heat Speed

8.5. Electric Heat Operation

8.5.1. Electric Heat Stage Delay Operation

First-stage heating demand energizes first-stage electric heat (K15 and K17). Second-stage heating demand energizes second-stage electric heat (K16 and K18). When first-stage and second-stage heating demands are simultaneous, a delay will occur between stage one and two (Parameter 62). Default delay is 12 seconds. Optional range setting is 12 to 60 seconds.

Go to RTU MENU > SETTINGS > RTU OPTION > EDIT PARAMETER = 62 (HT ELEC STAGE DELAY)

8.5.2. Primary or Secondary Limits

- If an electric heat limit (S15 or S63) opens, electric heat de-energizes.
- If an electric heat limit opens three times (default) during a thermostat cycle, in addition, the service alarm output turns on. Valid options for Parameter 61 are 1 through 15.

Go to RTU MENU > SETTINGS > RTU OPTION > EDIT PARAMETER = 61 (HT ELEC MAX LT OCC)

8.6. Mechanical Heat Operation

Heat Pump models activate heat sources based on heating demand and suitability of outdoor air temperature. Mechanical (compressor) heating is the primary heat source, and it will activate for first-stage heating demands during standard operation. The secondary heat source, if equipped, will be used for higher heating demand stages. LHT (and a select few SHH) Heat Pump units may activate the electric heat while mechanical heating is active to provide greater heat output. Dual Fuel (LDT/SDH) units shall operate either mechanical heating or gas heating for a given demand; mechanical and gas heating will not operate concurrently. See the tables for LHT/SHH and LDT/SDH operation in section "6.1.2. Heating Stages" on page 34.

The controller will lockout mechanical heating when the ambient outdoor air temperature is too low for efficient operation. The temperature at which mechanical heating is disabled/locked-out is configured using the following parameters. Weigh the comfort / cost benefit when changing these setpoints.

Go to RTU MENU > SETTINGS > RTU OPTIONS > EDIT PARAMETER = 526 (HP DF BALANCE POINT)

Temperature setpoint 526 controls when mechanical heat operation is locked-out for Dual Fuel (LDT/SDH) units. If OAT is below this balance point when a heating demand is received, the controller will not use (lockout) mechanical heating and instead use gas heating. This is only checked upon a change in demand; the controller will continue with the selected heat source until a change in heating demand is received. If the OAT sensor on an LDT/SDH unit fails, the controller will assume OAT is not suitable for HP use and

use gas heat instead. Note that this is only applicable to first-stage heating demands, because gas heat is used for higher stages regardless of OAT.

Go to RTU MENU > SETTINGS > RTU OPTIONS > EDIT PARAMETER = 527 (HP LAH COMP LKOUT TMP LO)

Go to RTU MENU > SETTINGS > RTU OPTIONS > EDIT PARAMETER = 528 (HP LAH COMP LKOUT TMP HI)

Temperature setpoints 527 and 528 control when mechanical heat operation is locked-out for LHT/SHH Heat Pump units. If OAT becomes less than parameter 527 while mechanical heating is operating, mechanical heating will be deactivated & locked-out. If OAT is below setpoint 528 when a heating demand is received, the controller will not use (lockout) mechanical heating. In either case, the secondary heat source will be activated if equipped. If the OAT sensor on an LHT/SHH unit fails, the controller will assume OAT is suitable for HP use.

8.6.1. Enhanced HP Heating Efficiency – 2-Ton LH/LD Units

2-ton units may automatically increase mechanical heating at low ambient outdoor temperatures to boost heating efficiency. No configuration or user intervention is required to activate this enhanced operation.

8.7. Defrost Operation

Frost develops on the outdoor coil during mechanical heating based on ambient temperature and humidity level. The controller will automatically perform periodic defrost cycles to remove this frost and restore operational efficiency. The secondary heat source will be activated during a defrost cycle on units with one compressor circuit to provide heating and prevent cooling of the space. For LHT units with no secondary heat source, the conditioned space may experience brief periods of cool discharge air during a defrost cycle. If heating demand is still present once the defrost cycle is complete, the circuit returns to heating operation, and other circuits may enter defrost if needed. Some defrost cycle behavior may be modified with the following parameters.

Go to RTU MENU > SETTINGS > RTU OPTIONS > EDIT PARAMETER = 45 (HP MAX DFST TIME)

Parameter 45 is the length of time that any one circuit will remain in defrost. Ideally, the defrost cycle will end before this time when the outdoor coil temperature reaches the defrost exit temperature setpoint, parameter 48.

Go to RTU MENU > SETTINGS > RTU OPTIONS > EDIT PARAMETER = 46 (HP MIN DFST INTVL)

Parameter 46 defines the minimum time required before a subsequent defrost cycle may run on a particular circuit. For example, if circuit 2 just completed a defrost cycle, circuit 2 will not begin another defrost cycle for 30 minutes (default) even if there is a need for defrosting before this time.

For Strategos HP models: If the unit has 2 compressors, then the compressor not in defrost will run in heating at the same speed as the compressor in defrost. This will provide neutral air to the space. For one compressor systems, the secondary heat source will be activated if present. For systems that do not have a secondary heat source, a configurable option is available that will allow the user to disable the blower during defrost. Parameter 606 (No

Blower Defrost): The default of this parameter is 0, which means the blower will run during defrost. If this parameter is changed to a 1, then the blower will turn off during defrost to prevent cold air going into the space. This feature is only available on single compressor systems without a secondary heat source.

**Go to RTU MENU > SETTINGS > RTU OPTIONS > EDIT
PARAMETER = 47 (HP DFST LO TMP)**

The controller tracks the accumulated low-temperature runtime of the mechanical heating and uses this runtime to initiate defrost cycles. Parameter 47 defines the outdoor coil temperature below which the runtime is considered low-temperature. Increasing this setpoint value will result in more defrost cycles, which may be more than necessary - decreasing efficiency and heating capacity; decreasing the setpoint will result in fewer defrost cycles, which may allow an increased buildup of ice - decreasing efficiency and heating capacity.

**Go to RTU MENU > SETTINGS > RTU OPTIONS > EDIT
PARAMETER = 48 (HP DFST EXIT TMP)**

Parameter 48 is the temperature at which the outdoor coil is considered defrosted and the defrost cycle will end. If the outdoor coil temperature has not reached this value during the defrost cycle before the time set in parameter 45 has elapsed, the cycle will terminate anyway, and the circuit will resume heating.

8.8. Reversing Valve Operation

Heat Pump units use a reversing valve to reverse the flow of refrigerant to achieve either cooling or heating of the conditioned space. The reversing valve defaults to its unenergized state which enables heating operation, and the reversing valve is energized to enable cooling or defrost operation. By default, the controller stops the compressor any time the reversing valve needs to change state. This behavior can be modified using this parameter:

**Go to RTU MENU > SETTINGS > RTU OPTIONS > EDIT
PARAMETER = 57 (HP COMP STOP ON RV STATE SW)**

Binary parameter 57 determines whether the compressor will stop when the reversing valve needs to change state, for example switching to a defrost cycle from mechanical heating. The default of True (1) pauses compressor operation for the RV to actuate; False (0) will actuate the reversing valve while the compressor continues operating.

NOTE: *Disabling this feature may result in a loud percussive sound upon actuation of the valve due to hammer effect of the refrigerant. This note DOES NOT apply to Strategos models.*

For Strategos HP models: The compressor does not need to stop in order to change the reversing valve state. When a defrost is needed for a compressor, the speed of the compressor is changed to the defrost speed. Once the compressor reaches the defrost speed, the reversing valve is energized for the defrost cycle. When the defrost cycle is over, the reversing valve is de-energized without stopping the compressor. The compressor speed is then changed to the heating speed.

9. Sensors

The M4 unit controller is only compatible with sensors provided with the unit or purchased separately as specified in the Product Specification.

IMPORTANT

All 0-10 VDC sensors require two separate twisted pair cables with shield. One cable is used for the 24VAC power and one cable is used for the 0-10 VDC output. Room sensors require a single twisted pair cable with shield. The shield drain wires must be connected to the common at the unit field wiring terminal block only. The shield drain wires must not be connected to common at the sensor. Non-communicating temperature sensors require single twisted pair wire only.

9.1. Temperature Sensors

The following various temperature sensors are used in Model L roof-top units:

Table 32. Model L and Enlight Temperature Sensors

Sensor Type	Component Key			
Return Air	RT16			
Discharge Air	RT6			
Outdoor Air	RT17			
Compressor Suction	RT42	RT43	RT54	RT55
Compressor Liquid	RT44	RT45	RT56	RT57
Compressor Saturated Suction	RT46	RT47	RT50	RT51
Compressor Saturated Liquid	RT48	RT49	RT52	RT53

RT42 through RT57, Temp Range is -40°F to 150°F (170°F Sat. Liq.), Resistance at 10,000 ohms is 77°F (25°C), Tolerance is +/- 1% and Type is NTC

Table 33. Resistance Vs. Temperature

Temp. °F (°C)	Resistance +/-2%	Temp °F (°C)	Resistance +/-2%	Temp. °F (°C)	Resistance +/-2%
-40 (-40)	335,671	40 (4.4)	26,106	90 (32.2)	7,332
-20 (-28.9)	164,959	50 (10)	19,904	100 (37.8)	5,826
0 (-17.8)	85,323	60 (15.6)	15,313	120 (48.9)	3,756
20 (-6.7)	46,218	70 (21.1)	11,884	130 (54.4)	3,047
30 (-1.1)	34,566	80 (26.7)	9,298		

9.2. Room Sensor - Optional

Room sensor (A2) is a two-wire thermistor with 1k series resistor. The unit controller can be configured to operate with 10k traditional room sensors by setting Parameter 421 to a value of 1 (Default 0).

Table 34. Two-Wire Thermistor

Temp. °F (°C)	Resistance +/-2%	Temperature °F (°C)	Resistance +/-2%	Temp. °F (°C)	Resistance +/-2%
40 (4.4)	27,102	60 (15.6)	16,313	80 (26.7)	10,299
45 (7.2)	23,764	65 (18.3)	14,474	85 (29.4)	9,249
50 (10)	20,898	70 (21.1)	12,882	90 (32.2)	8,529
55 (12.8)	18,433	75 (23.9)	11,498		

9.3. Relative Humidity Sensor - Optional

The indoor relative humidity sensor (J298.5) is an analog sensor with a 0-10 VDC output over a relative humidity range of 0-100% relative humidity. The sensor is powered with 24VAC.

9.4. Carbon Dioxide (Indoor Air Quality) Sensor - Optional

The indoor carbon dioxide sensor (J298.3) is an analog sensor with a 0-10 VDC output over a carbon dioxide range of 0-2000 ppm as shown in the following table. The sensor is powered with 24VAC.

Table 35. Carbon Dioxide Range

Carbon Dioxide PPM	DC Voltage	Carbon Dioxide PPM	DC Voltage	Carbon Dioxide PPM	DC Voltage	Carbon Dioxide PPM	DC Voltage
0	0	600	3	1200	6	1800	9
200	1	800	4	1400	7	2000	10
400	2	1000	5	1600	8		

9.5. Supply Static Pressure Sensor - Optional

The supply duct differential static pressure sensor (J378) is an analog sensor with a 0-10 VDC output over a range of 0-5"w.c as shown in the following table. The sensor is powered with 24VAC.

Table 36. Supply Static Pressure Sensor

Pressure "w.c.	DC Voltage	Pressure "w.c.	DC Voltage	Pressure "w.c.	DC Voltage	Pressure "w.c.	DC Voltage
0	0	1.5	3	3	6	4.5	9
0.5	1	2	4	3.5	7	5	10
1	2	2.5	5	4	8		

9.6. Enthalpy Sensor - Optional

The optional enthalpy sensors (J384.5 for negative side, and J384.12 or J384.14 for positive side for the outdoor sensor) used with the economizer have an output of 4-20mA. The sensor is powered with 18VAC provided by M4 unit controller.

9.7. Sensors (Strategos Heat Pump Units Only)

9.7.1. High Pressure Transducer (PT7, PT10)

- PT7: All Units
- PT10: SDH180-SDH240 units

The High Pressure Transducer monitors the compressor discharge pressures and protects from abnormal conditions.

9.7.2. Low Pressure Transducer (PT8, PT11)

- PT8: All Units
- PT11: SDH180-SDH240 units

The Low Pressure Transducer monitors the compressor suction pressures and protects from abnormal conditions.

9.7.3. Liquid Pressure Transducer (PT9, PT12)

- PT9: All Units
- PT12 SDH180-SDH 240 units

The Liquid Pressure Transducer monitors the compressor liquid pressures and protects from abnormal conditions.

9.7.4. Discharge Line Thermistor (RT66, RT67)

- RT66: All Units
- RT67: 180-240 Units

The Discharge Line Thermistor monitors and protects the compressor from excessive temperatures.

10. Outdoor Fan Operations during Various Ambient Conditions

10.1. High Ambient Conditions - LCM/LGM B and C Box; Enlight A, B, C Box (7-1/2 to 25-ton); Strategos A Box

Under high ambient conditions (outdoor air temperature greater than 105°F), if one or both compressors are running, then all the fans corresponding to that circuit, run at speed set in Parameter 96 - FAN HI AMBIENT SPD. When the outdoor air temperature drops below 100°F, the fans will switch to normal ambient condition speed.

NOTE: The high ambient fan operations are not applicable to the non ECM fan configurations.

10.2. Normal Ambient Conditions

During normal ambient operation, the fan speed is based on the compressor speed and compressor status (fixed speed compressors).

10.3. Low Ambient Conditions

Enlight and Strategos

The unit will enter low ambient cooling state when the temperature for low ambient is 55°F (parameter 84 DIN_LAC_SP_Temp_2).

The unit will exit low ambient cooling state when below the conditions are met:

- The SLT \geq MAX(LAC_SLT_exit_limit, LA_HIGH_SLT_THRESH + 5) (new DIN "LAC_SLT_exit_limit [80,140,110] F) for continuous duration of LAC_SLT_persistence_time (new DIN "LAC_SLT_persistence_time" [0,180,30] seconds)

AND

- Single fan operation has been ON for continuous duration of LAC_Fan_ON_time (new DIN "LAC_Fan_ON_time" [0,600,300] seconds)

OR

- Demand is removed or satisfied.

OR

- When the OAT sensor has not failed and its value is greater than 62°F if the compressors are not running.

At low outdoor temperatures, each fan is either turned OFF or run at a rate determined by the condenser coil Saturated Liquid Temperature (SLT) for the compressor circuit(s) associated with that fan.

When fan speed is being controlled based on SLT, the controller algorithm will run in one of three modes: 1) Fan OFF 2) Fan at MIN SPEED or 3) Modulate fan speed according to SLT

During low ambient operation, the fan may cycle between these three modes as needed to maintain the desired Saturated Liquid Temperature.

NOTE: If the outdoor air temperature sensor fails, outdoor fans will follow the Normal Ambient Conditions.

10.4. Compressor / Fan Key

Table 37. Key

Key	Description	Key	Description
A55	M4 board. Main RTU control board.	K14	Contactors, Compressor 3
A178	Panel, Compressor 3 and 4, C4 second stage heat.	K146	Contactors, Compressor 4
B4	Motor, Outdoor Fan 1	PWM	Pulse Width Modulated Signal
B5	Motor, Outdoor Fan 2	SLT	During low ambient conditions, various outdoor fans are cycled by saturated liquid temperature (SLT) thermistors RT48, RT52, RT49, RT53.
B21	Motor, Outdoor Fan 3		
B22	Motor, Outdoor Fan 4		
B23	Motor, Outdoor Fan 5		
B24	Motor, Outdoor Fan 6		
B1	Compressor 1		
B2	Compressor 2		
B13	Compressor 3		

Table 37. Key

Key	Description	Key	Description
B20	Compressor 4		
K1	Contactora, Compressor 1		
K2	Contactora, Compressor 2		
S11 or PWM	Relay, Outdoor Fan 1		

10.5. Compressor / Fan Configurations

See unit installation instruction or service manual for specific operational details.

Table 38. LCM/LGM - Number of Compressor / Fans and Fan Layouts


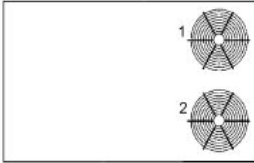
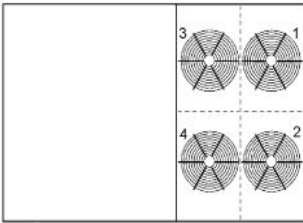
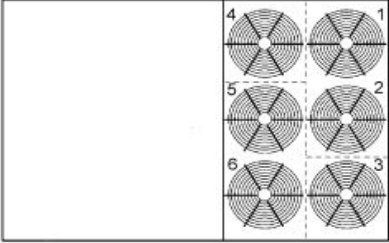
Box Size	Fan Layout	Models	Compr.	Fans
A BOX		LCM, LGM 036U, 048U, 060U and 074U	1 (variable)	1 (variable)
B BOX		LCM, LGM 092U, 102U, 120U and 150U	1 (variable) + 1 Single-Stage	2 (variable)
C2 BOX		LCM, LGM 156U and 180U	1 (variable) + 2 Single Stage	4 (Variable)
C3 BOX		LCM, LGM 210U, 240U and 300U	1 (variable) + 3 Single Stage	6 (variable)

Table 39. LGT/LCT/SCH/SGH - Number of Compressor / Fans and Fan Layouts


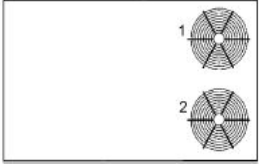
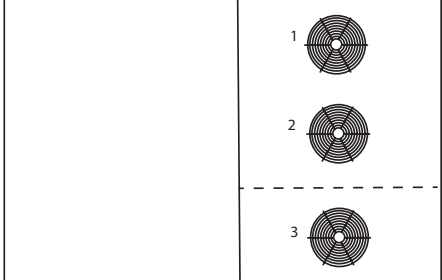
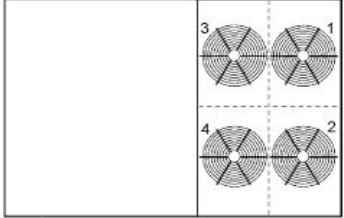
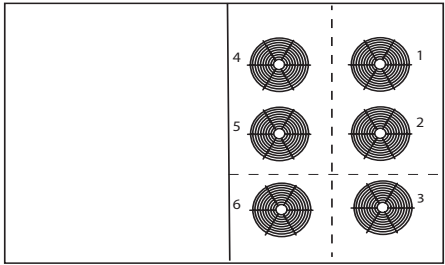
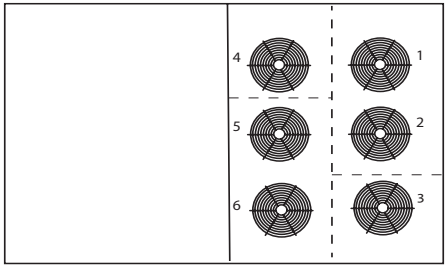

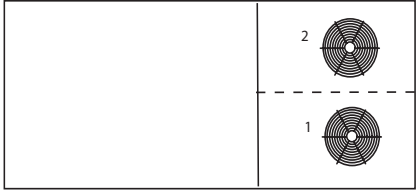
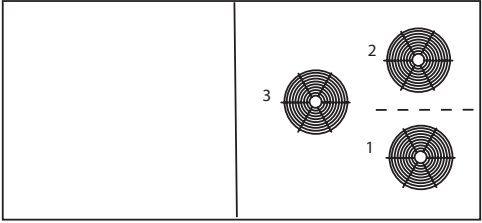
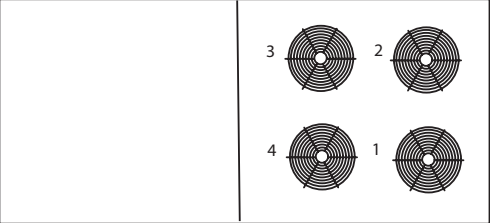
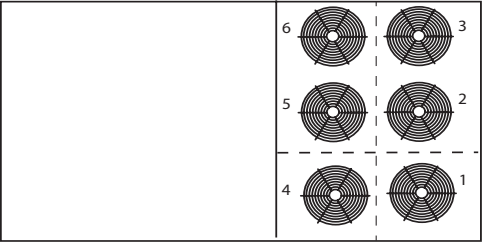
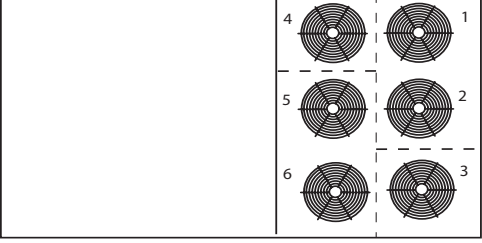
Box Size	Fan Layout	Models	Compr.	Fans
A BOX		LGT, LCT 036H, 048H, 060H and 072H	1 Two-Stage	1 (variable)
B BOX		LGT, LCT 092H, 102H, 120H and 150H	1 Two-Stage + 1 Single Stage.	2 (fixed)
C1 BOX		LGT, LCT 156H	1 Two-Stage + 1 Single Stage	2 fixed + 1 variable
C2 BOX		LGT, LCT 180H, 210H	3 Single Stage (180H) and 4 Single Stage (210H)	2 fixed + 2 variable
C3 BOX		LGT, LCT 240H, 300S, and 300H	4 Single Stage	4 fixed + 2 variable
D BOX		LGT, LCT 302H and 360H SGH/SCH 240H	4 Single Stage	6 (fixed speed)

Table 40. LHT/LDT - Number of Compressor / Fans and Fan Layouts













Box Size	Fan Layout	Models	Compr.	Fans
A BOX		LHT, LDT 024H, 036H, 048H, 060H, 072H NOTE: 072H is A2L refrigerant only.	1 Two Stage	1 (variable)
B BOX		LHT, LDT 078H, 092H, 102H, and 120H NOTE: 120H is A2L refrigerant only.	1 (Two-Stage) + 1 Single-Stage	2 (variable)
B2 BOX		LHT, LDT 122H and 150H	1 Two-Stage + 1 Single Stage	3 (variable)
B3 BOX		LHT, LDT 152 NOTE: A2L refrigerant only.	1 Two Stage + 1 Single Stage	4 Variable
C3 Box		LHT, LDT 156H, 180H and 240H	1 Two-Stage + 1 Single Stage	6 (fixed speed)
D Box		LHT, LDT 302H	1 Two-Stage + 1 Single Stage	6 (fixed speed)

10.6. Low Ambient Outdoor Fan Control and Cycling

During low ambient conditions, various outdoor fans are cycled by saturated liquid temperature thermistors RT48, RT52, RT49, RT53. The M4 unit controller will also de-energize fans due to low outdoor temperature. See the following tables for further details.

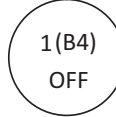


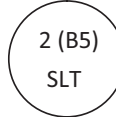
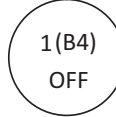


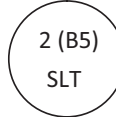
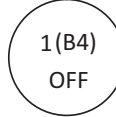


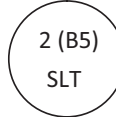
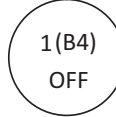


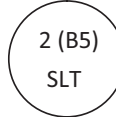
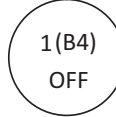


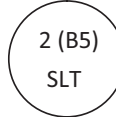
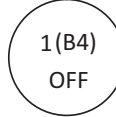


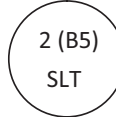
10.6.1. A Box LCM/LGM 036U, 048U, 060U and 074U

Table 41. Low Ambient Outdoor Fan Control and Cycling - A Box

Models	Fan	Associated Compressor	Entry is OAT < 62°F and exit is OAT >=65°F for all models.												
036U, 048U, 060U and 074U	B4	B1	B4 - OFF/MIN SPEED/Modulate depending on Saturated Liquid Temperature (SLT) value/history												
<table border="1" style="width: 100%; border-collapse: collapse;"> <tr> <td style="width: 50%; vertical-align: top; padding: 5px;"> <p>A BOX</p> <p>Gas / Electric & Electric / Electric</p> <table style="width: 100%; border-collapse: collapse;"> <tr> <td style="width: 30%;">036U</td> <td>3 TON</td> </tr> <tr> <td>048U</td> <td>4 TON</td> </tr> <tr> <td>060U</td> <td>5 TON</td> </tr> <tr> <td>074U</td> <td>6 TON</td> </tr> </table> </td> <td style="width: 50%; vertical-align: top; padding: 5px;"> <table border="1" style="width: 100%; border-collapse: collapse;"> <tr> <td style="text-align: center; padding: 5px;"> Condenser Fan  B1 - A55 - P383-4 </td> </tr> <tr> <td style="text-align: center; padding: 5px;"> Compressor  A55-K1 </td> </tr> </table> </td> </tr> </table>				<p>A BOX</p> <p>Gas / Electric & Electric / Electric</p> <table style="width: 100%; border-collapse: collapse;"> <tr> <td style="width: 30%;">036U</td> <td>3 TON</td> </tr> <tr> <td>048U</td> <td>4 TON</td> </tr> <tr> <td>060U</td> <td>5 TON</td> </tr> <tr> <td>074U</td> <td>6 TON</td> </tr> </table>	036U	3 TON	048U	4 TON	060U	5 TON	074U	6 TON	<table border="1" style="width: 100%; border-collapse: collapse;"> <tr> <td style="text-align: center; padding: 5px;"> Condenser Fan  B1 - A55 - P383-4 </td> </tr> <tr> <td style="text-align: center; padding: 5px;"> Compressor  A55-K1 </td> </tr> </table>	Condenser Fan  B1 - A55 - P383-4	Compressor  A55-K1
<p>A BOX</p> <p>Gas / Electric & Electric / Electric</p> <table style="width: 100%; border-collapse: collapse;"> <tr> <td style="width: 30%;">036U</td> <td>3 TON</td> </tr> <tr> <td>048U</td> <td>4 TON</td> </tr> <tr> <td>060U</td> <td>5 TON</td> </tr> <tr> <td>074U</td> <td>6 TON</td> </tr> </table>	036U	3 TON	048U	4 TON	060U	5 TON	074U	6 TON	<table border="1" style="width: 100%; border-collapse: collapse;"> <tr> <td style="text-align: center; padding: 5px;"> Condenser Fan  B1 - A55 - P383-4 </td> </tr> <tr> <td style="text-align: center; padding: 5px;"> Compressor  A55-K1 </td> </tr> </table>	Condenser Fan  B1 - A55 - P383-4	Compressor  A55-K1				
036U	3 TON														
048U	4 TON														
060U	5 TON														
074U	6 TON														
Condenser Fan  B1 - A55 - P383-4															
Compressor  A55-K1															

10.6.2. B Box LCM/LGM 092U, 102U, 120U and 150U

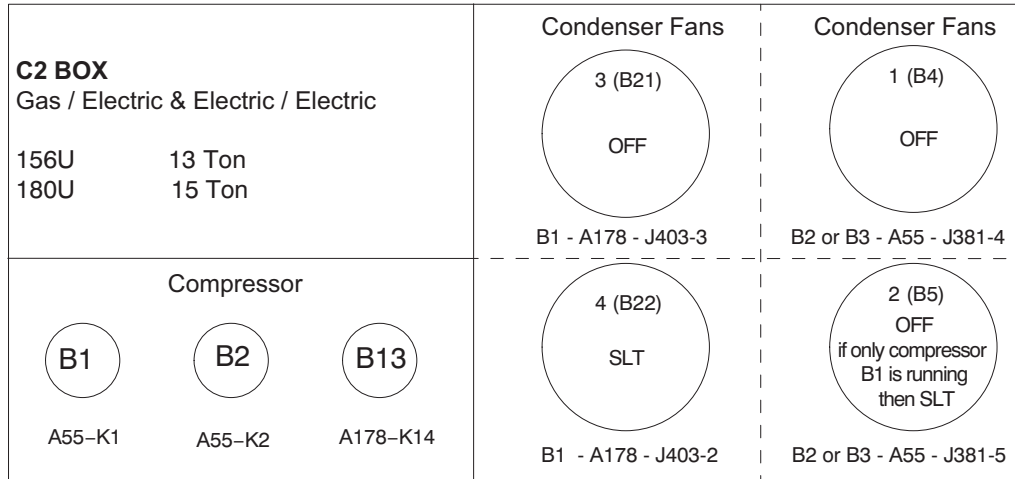
Table 42. Low Ambient Outdoor Fan Control and Cycling - B Box

Models	Fan	Associated Compressor	Entry is OAT < 62°F and exit is OAT >=65°F for all models.													
092U, 102U, 120U and 150U	B4	B1, B2	OFF													
	B5	B1, B2	B5 - OFF/ON depending on Saturated Liquid Temperature (SLT) value/history													
<table border="1" style="width: 100%; border-collapse: collapse;"> <tr> <td style="width: 50%; vertical-align: top; padding: 5px;"> <p>B BOX</p> <p>Gas / Electric & Electric / Electric:</p> <table style="width: 100%; border-collapse: collapse;"> <tr> <td style="width: 30%;">092U</td> <td>7 ½ ton</td> </tr> <tr> <td>102U</td> <td>8 ½ ton</td> </tr> <tr> <td>120U</td> <td>10 ton</td> </tr> <tr> <td>150U</td> <td>12 ton</td> </tr> </table> </td> <td style="width: 50%; vertical-align: top; padding: 5px;"> <table border="1" style="width: 100%; border-collapse: collapse;"> <tr> <td style="text-align: center; padding: 5px;"> Condenser Fans  B1 or B2 - A55 - J381-4 </td> </tr> <tr> <td style="text-align: center; padding: 5px;"> Compressors <div style="display: flex; justify-content: space-around; align-items: center;"> <div style="text-align: center;">  A55-K1 </div> <div style="text-align: center;">  A55-K2 </div> </div> </td> </tr> <tr> <td style="text-align: center; padding: 5px;">  B1 or B2 - A55 - J381-5 </td> </tr> </table> </td> </tr> </table>				<p>B BOX</p> <p>Gas / Electric & Electric / Electric:</p> <table style="width: 100%; border-collapse: collapse;"> <tr> <td style="width: 30%;">092U</td> <td>7 ½ ton</td> </tr> <tr> <td>102U</td> <td>8 ½ ton</td> </tr> <tr> <td>120U</td> <td>10 ton</td> </tr> <tr> <td>150U</td> <td>12 ton</td> </tr> </table>	092U	7 ½ ton	102U	8 ½ ton	120U	10 ton	150U	12 ton	<table border="1" style="width: 100%; border-collapse: collapse;"> <tr> <td style="text-align: center; padding: 5px;"> Condenser Fans  B1 or B2 - A55 - J381-4 </td> </tr> <tr> <td style="text-align: center; padding: 5px;"> Compressors <div style="display: flex; justify-content: space-around; align-items: center;"> <div style="text-align: center;">  A55-K1 </div> <div style="text-align: center;">  A55-K2 </div> </div> </td> </tr> <tr> <td style="text-align: center; padding: 5px;">  B1 or B2 - A55 - J381-5 </td> </tr> </table>	Condenser Fans  B1 or B2 - A55 - J381-4	Compressors <div style="display: flex; justify-content: space-around; align-items: center;"> <div style="text-align: center;">  A55-K1 </div> <div style="text-align: center;">  A55-K2 </div> </div>	 B1 or B2 - A55 - J381-5
<p>B BOX</p> <p>Gas / Electric & Electric / Electric:</p> <table style="width: 100%; border-collapse: collapse;"> <tr> <td style="width: 30%;">092U</td> <td>7 ½ ton</td> </tr> <tr> <td>102U</td> <td>8 ½ ton</td> </tr> <tr> <td>120U</td> <td>10 ton</td> </tr> <tr> <td>150U</td> <td>12 ton</td> </tr> </table>	092U	7 ½ ton	102U	8 ½ ton	120U	10 ton	150U	12 ton	<table border="1" style="width: 100%; border-collapse: collapse;"> <tr> <td style="text-align: center; padding: 5px;"> Condenser Fans  B1 or B2 - A55 - J381-4 </td> </tr> <tr> <td style="text-align: center; padding: 5px;"> Compressors <div style="display: flex; justify-content: space-around; align-items: center;"> <div style="text-align: center;">  A55-K1 </div> <div style="text-align: center;">  A55-K2 </div> </div> </td> </tr> <tr> <td style="text-align: center; padding: 5px;">  B1 or B2 - A55 - J381-5 </td> </tr> </table>	Condenser Fans  B1 or B2 - A55 - J381-4	Compressors <div style="display: flex; justify-content: space-around; align-items: center;"> <div style="text-align: center;">  A55-K1 </div> <div style="text-align: center;">  A55-K2 </div> </div>	 B1 or B2 - A55 - J381-5				
092U	7 ½ ton															
102U	8 ½ ton															
120U	10 ton															
150U	12 ton															
Condenser Fans  B1 or B2 - A55 - J381-4																
Compressors <div style="display: flex; justify-content: space-around; align-items: center;"> <div style="text-align: center;">  A55-K1 </div> <div style="text-align: center;">  A55-K2 </div> </div>																
 B1 or B2 - A55 - J381-5																

10.6.3. C2 Box LCM/LGM 156U and 180U

Table 43. Low Ambient Outdoor Fan Control and Cycling - C2 Box

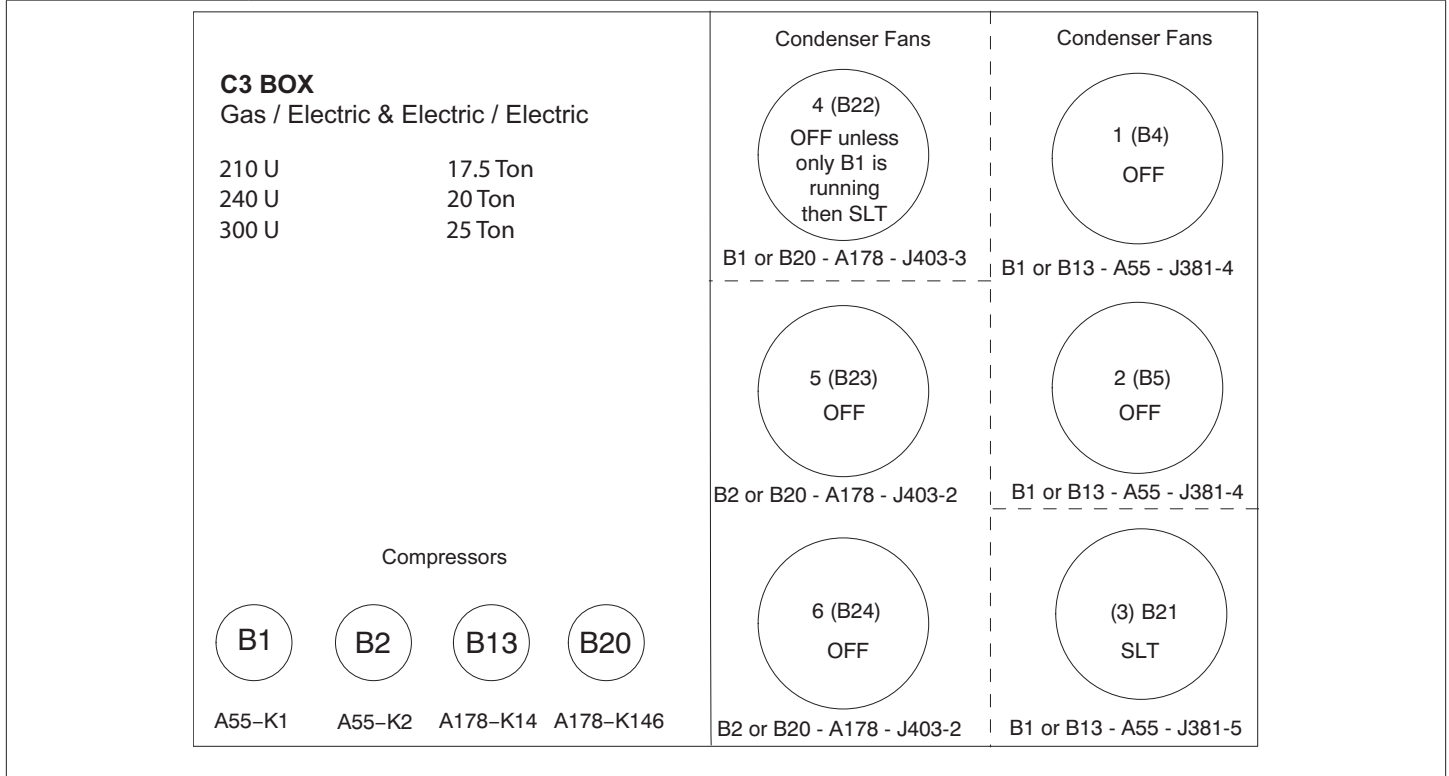
Models	Fan	Associated Compressor	Entry is OAT < 62°F and exit is OAT >=65°F for all models.
156U and 180U	B4	B2, B13	OFF
	B5	B2, B13	B5 - OFF (if only Compressor C1 is running) or OFF/MIN SPEED/Modulate or depending on Saturated Liquid Temperature (SLT) value/history
	B21	B1	OFF
	B22	B1	B22 - OFF/MIN SPEED/Modulate depending on Saturated Liquid Temperature (SLT) value/history



10.6.4. C3 Box LCM/LGM 210U, 240U and 300U







Table 44. Low Ambient Outdoor Fan Control and Cycling - C3 Box

Models	Fan	Associated Compressor	Entry is OAT < 62°F and exit is OAT >=65°F for all models.
210U, 240U, and 300U	B4	B1, B13	B4 - OFF
	B5	B1, B13	B5 - OFF
	B21	B1, B13	B21 - OFF/MIN SPEED/Modulate depending on Saturated Liquid Temperature (SLT) value/history
	B22	B2, B20	B22 - OFF (if only Compressor C1 is running) or OFF/MIN SPEED/Modulate depending on Saturated Liquid Temperature (SLT) value/history
	B23	B2, B20	B23 - OFF
	B24	B2, B20	B24 - OFF



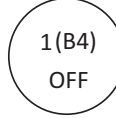


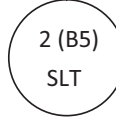
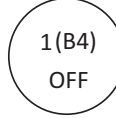


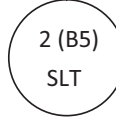
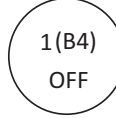


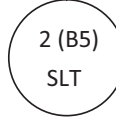
10.6.5. A Box LGT, LCT 036H, 048H, 060H and 072H

Table 45. Low Ambient Outdoor Fan Control and Cycling - A Box

Models	Fan	Associated Compressor	Entry is OAT < 55°F and exit is OAT >=58°F for all models (see parameter 84)										
LGT, LCT 036H, 048H, 060H and 072H	B4	B1	B4 - OFF/MIN SPEED/Modulate depending on Saturated Liquid Temperature (SLT) value/history										
<table border="1" style="width: 100%; border-collapse: collapse;"> <tr> <td style="width: 50%; vertical-align: top; padding: 5px;"> <p>A BOX</p> <p>Gas / Electric & Electric / Electric</p> <table style="width: 100%; border: none;"> <tr> <td style="padding-right: 20px;">036H</td> <td>3 Ton</td> </tr> <tr> <td>048H</td> <td>4 Ton</td> </tr> <tr> <td>060H</td> <td>5 Ton</td> </tr> <tr> <td>072H</td> <td>6 Ton</td> </tr> </table> </td> <td style="width: 50%; vertical-align: top; padding: 5px;"> <p>Condenser Fan</p> <div style="text-align: center;">  <p>1 (B4) SLT</p> </div> <p>B1 - A55 - J381-4</p> <hr/> <p>Compressor</p> <div style="text-align: center;">  <p>B1</p> </div> <p>A55-K1</p> </td> </tr> </table>				<p>A BOX</p> <p>Gas / Electric & Electric / Electric</p> <table style="width: 100%; border: none;"> <tr> <td style="padding-right: 20px;">036H</td> <td>3 Ton</td> </tr> <tr> <td>048H</td> <td>4 Ton</td> </tr> <tr> <td>060H</td> <td>5 Ton</td> </tr> <tr> <td>072H</td> <td>6 Ton</td> </tr> </table>	036H	3 Ton	048H	4 Ton	060H	5 Ton	072H	6 Ton	<p>Condenser Fan</p> <div style="text-align: center;">  <p>1 (B4) SLT</p> </div> <p>B1 - A55 - J381-4</p> <hr/> <p>Compressor</p> <div style="text-align: center;">  <p>B1</p> </div> <p>A55-K1</p>
<p>A BOX</p> <p>Gas / Electric & Electric / Electric</p> <table style="width: 100%; border: none;"> <tr> <td style="padding-right: 20px;">036H</td> <td>3 Ton</td> </tr> <tr> <td>048H</td> <td>4 Ton</td> </tr> <tr> <td>060H</td> <td>5 Ton</td> </tr> <tr> <td>072H</td> <td>6 Ton</td> </tr> </table>	036H	3 Ton	048H	4 Ton	060H	5 Ton	072H	6 Ton	<p>Condenser Fan</p> <div style="text-align: center;">  <p>1 (B4) SLT</p> </div> <p>B1 - A55 - J381-4</p> <hr/> <p>Compressor</p> <div style="text-align: center;">  <p>B1</p> </div> <p>A55-K1</p>				
036H	3 Ton												
048H	4 Ton												
060H	5 Ton												
072H	6 Ton												

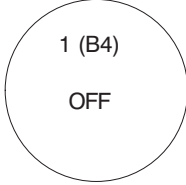
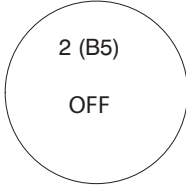
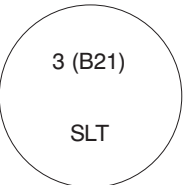


10.6.6. B Box LGT, LCT 092H, 102H, 120H and 150H

Table 46. Low Ambient Outdoor Fan Control and Cycling - B Box

Models	Fan	Associated Compressor	Entry is OAT < 55°F and exit is OAT >=58°F for all models (see parameter 84)												
LGT, LCT 092H, 102H, 120H and 150H	B4	B1, B2	B4 - OFF												
	B5	B1, B2	B5 - ON/OFF depending on Saturated Liquid Temperature (SLT) value/history												
<table border="1" style="width: 100%; border-collapse: collapse;"> <tr> <td style="width: 50%; vertical-align: top; padding: 5px;"> <p>B BOX</p> <p>Gas / Electric & Electric / Electric:</p> <table style="width: 100%; border: none;"> <tr> <td style="padding-right: 20px;">092H</td> <td>7 ½ Ton</td> </tr> <tr> <td>102H</td> <td>8 ½ Ton</td> </tr> <tr> <td>120H</td> <td>10 Ton</td> </tr> <tr> <td>150H</td> <td>12.5 Ton</td> </tr> </table> </td> <td style="width: 50%; vertical-align: top; padding: 5px;"> <p>Condenser Fans</p> <div style="text-align: center;">  <p>1 (B4) OFF</p> </div> <p>B1 or B2 - A55 - J390-1</p> <hr/> <p>Compressors</p> <div style="display: flex; justify-content: space-around; align-items: center;"> <div style="text-align: center;">  <p>B1</p> <p>A55-K1</p> </div> <div style="text-align: center;">  <p>B2</p> <p>A55-K2</p> </div> </div> </td> </tr> <tr> <td colspan="2" style="vertical-align: top; padding: 5px;"> <div style="text-align: center;">  <p>2 (B5) SLT</p> </div> <p>B1 or B2 - A55 - J390-2</p> </td> </tr> </table>				<p>B BOX</p> <p>Gas / Electric & Electric / Electric:</p> <table style="width: 100%; border: none;"> <tr> <td style="padding-right: 20px;">092H</td> <td>7 ½ Ton</td> </tr> <tr> <td>102H</td> <td>8 ½ Ton</td> </tr> <tr> <td>120H</td> <td>10 Ton</td> </tr> <tr> <td>150H</td> <td>12.5 Ton</td> </tr> </table>	092H	7 ½ Ton	102H	8 ½ Ton	120H	10 Ton	150H	12.5 Ton	<p>Condenser Fans</p> <div style="text-align: center;">  <p>1 (B4) OFF</p> </div> <p>B1 or B2 - A55 - J390-1</p> <hr/> <p>Compressors</p> <div style="display: flex; justify-content: space-around; align-items: center;"> <div style="text-align: center;">  <p>B1</p> <p>A55-K1</p> </div> <div style="text-align: center;">  <p>B2</p> <p>A55-K2</p> </div> </div>	<div style="text-align: center;">  <p>2 (B5) SLT</p> </div> <p>B1 or B2 - A55 - J390-2</p>	
<p>B BOX</p> <p>Gas / Electric & Electric / Electric:</p> <table style="width: 100%; border: none;"> <tr> <td style="padding-right: 20px;">092H</td> <td>7 ½ Ton</td> </tr> <tr> <td>102H</td> <td>8 ½ Ton</td> </tr> <tr> <td>120H</td> <td>10 Ton</td> </tr> <tr> <td>150H</td> <td>12.5 Ton</td> </tr> </table>	092H	7 ½ Ton	102H	8 ½ Ton	120H	10 Ton	150H	12.5 Ton	<p>Condenser Fans</p> <div style="text-align: center;">  <p>1 (B4) OFF</p> </div> <p>B1 or B2 - A55 - J390-1</p> <hr/> <p>Compressors</p> <div style="display: flex; justify-content: space-around; align-items: center;"> <div style="text-align: center;">  <p>B1</p> <p>A55-K1</p> </div> <div style="text-align: center;">  <p>B2</p> <p>A55-K2</p> </div> </div>						
092H	7 ½ Ton														
102H	8 ½ Ton														
120H	10 Ton														
150H	12.5 Ton														
<div style="text-align: center;">  <p>2 (B5) SLT</p> </div> <p>B1 or B2 - A55 - J390-2</p>															

10.6.7. C1 Box LGT, LCT 156H

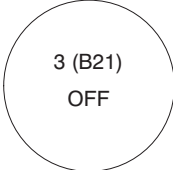
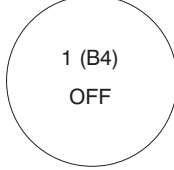

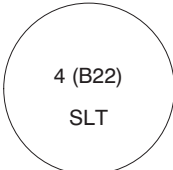
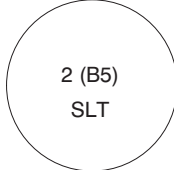
Table 47. Low Ambient Outdoor Fan Control and Cycling - C1 Box

Models	Fan	Associated Compressor	Entry is OAT < 55°F and exit is OAT >=58°F for all models (see parameter 84)
LGT, LCT 156H	B4	B1, B2	B4 - OFF
	B5	B1, B2	B5 - OFF
	B21	B1, B2	B21 - OFF/MIN SPEED/Modulate depending on Saturated Liquid Temperature (SLT) value/history
		<p>C1 BOX Gas / Electric & Electric / Electric 156H 13 Ton</p>	<p>Condenser Fans</p> <div style="text-align: center;">  <p>1 (B4) OFF</p> </div> <p>B1 or B2 - A55 - J390-1</p> <div style="text-align: center;">  <p>2 (B5) OFF</p> </div> <p>B1 or B2 - A55 - J390-1</p> <hr style="border-top: 1px dashed black;"/> <div style="text-align: center;">  <p>3 (B21) SLT</p> </div> <p>B1 or B2 - A55 - J381-4</p>
		<p>Compressors</p> <div style="display: flex; justify-content: space-around; align-items: center;"> <div style="text-align: center;">  <p>B1</p> <p>A55-K1</p> </div> <div style="text-align: center;">  <p>B2</p> <p>A55-K2</p> </div> </div>	

10.6.8. C2 Box LGT, LCT 180H

Table 48. Low Ambient Outdoor Fan Control and Cycling - C2 Box

Models	Fan	Associated Compressor	Entry is OAT < 55°F and exit is OAT >=58°F for all models (see parameter 84)
LGT, LCT 180H	B4	B2, B13	B4 - OFF
	B5	B2, B13	B5 - OFF/MIN SPEED/Modulate depending on Saturated Liquid Temperature (SLT) value/history
	B21	B1	B21 - OFF
	B22	B1	B22 - OFF/MIN SPEED/Modulate depending on Saturated Liquid Temperature (SLT) value/history

<p>C2 BOX</p> <p>Gas / Electric & Electric / Electric</p> <p>180H 15 Ton</p>	<p>Condenser Fans</p>  <p>3 (B21) OFF</p> <p>B1 - A178 - J397-1</p>	<p>Condenser Fans</p>  <p>1 (B4) OFF</p> <p>B2 or B13 - A55 - J390-1</p>
<p>Compressors</p>  <p>B1 B2 B13</p> <p>A55-K1 A55-K2 A178-K14</p>	 <p>4 (B22) SLT</p> <p>B1 - A178 - J403-2</p>	 <p>2 (B5) SLT</p> <p>B1 or B13 - A55 - J381-5</p>

10.6.9. C2 Box LGT, LCT 210H

Table 49. Low Ambient Outdoor Fan Control and Cycling - C2 Box

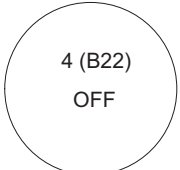
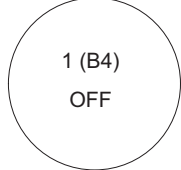
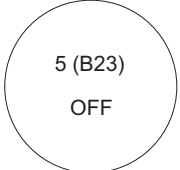
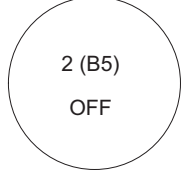




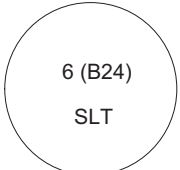
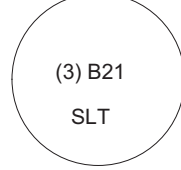
Models	Fan	Associated Compressor	Entry is OAT < 55°F and exit is OAT >=58°F for all models (see parameter 84)
LGT, LCT 210H	B4	B1, B2	B4 - OFF
	B5	B1, B2	B5 - OFF/MIN SPEED/Modulate depending on Saturated Liquid Temperature (SLT) value/history
	B21	B13, B20	B21 - OFF
	B22	B13, B20	B22 - OFF/MIN SPEED/Modulate depending on Saturated Liquid Temperature (SLT) value/history

<p>C2 BOX Gas / Electric & Electric / Electric 210H 17.5 Ton</p>	<p>Condenser Fans</p> <div style="border: 1px solid black; border-radius: 50%; width: 80px; height: 80px; margin: 0 auto; display: flex; align-items: center; justify-content: center;"> <div style="text-align: center;">3 (B21) OFF</div> </div> <p>B13 or B20 - A178 - J397-1</p>	<p>Condenser Fans</p> <div style="border: 1px solid black; border-radius: 50%; width: 80px; height: 80px; margin: 0 auto; display: flex; align-items: center; justify-content: center;"> <div style="text-align: center;">1 (B4) OFF</div> </div> <p>B1 or B2 - A55 - J390-1</p>
<p>Compressors</p> <div style="display: flex; justify-content: space-around; align-items: center;"> <div style="text-align: center;"> <div style="border: 1px solid black; border-radius: 50%; width: 40px; height: 40px; margin: 0 auto; display: flex; align-items: center; justify-content: center;">B1</div> <p>A55-K1</p> </div> <div style="text-align: center;"> <div style="border: 1px solid black; border-radius: 50%; width: 40px; height: 40px; margin: 0 auto; display: flex; align-items: center; justify-content: center;">B2</div> <p>A55-K2</p> </div> <div style="text-align: center;"> <div style="border: 1px solid black; border-radius: 50%; width: 40px; height: 40px; margin: 0 auto; display: flex; align-items: center; justify-content: center;">B13</div> <p>A178-K14</p> </div> <div style="text-align: center;"> <div style="border: 1px solid black; border-radius: 50%; width: 40px; height: 40px; margin: 0 auto; display: flex; align-items: center; justify-content: center;">B20</div> <p>A178-K146</p> </div> </div>	<div style="border: 1px solid black; border-radius: 50%; width: 100px; height: 100px; margin: 0 auto; display: flex; align-items: center; justify-content: center;"> <div style="text-align: center;">4 (B22) SLT</div> </div> <p>B13 or B20 - A178 - J403-2</p>	<div style="border: 1px solid black; border-radius: 50%; width: 100px; height: 100px; margin: 0 auto; display: flex; align-items: center; justify-content: center;"> <div style="text-align: center;">2 (B5) SLT</div> </div> <p>B1 or B2 - A55 - J381-5</p>

10.6.10.C3 Box LGT, LCT 240H, 300S, and 300H

Table 50. Low Ambient Outdoor Fan Control and Cycling - C3 Box

Models	Fan	Associated Compressor	Entry is OAT < 55°F and exit is OAT >=58°F for all models (see parameter 84)
LGT, LCT 240H, 300S, and 300H	B4	B1, B2	B4 - OFF
	B5	B1, B2	B5 - OFF
	B21	B1, B2	B21 - OFF/MIN SPEED/Modulate depending on Saturated Liquid Temperature (SLT) value/history
	B22	B13, B20	B22 - OFF
	B23	B13, B20	B23 - OFF
	B24	B13, B20	B24 - OFF/MIN SPEED/Modulate depending on Saturated Liquid Temperature (SLT) value/history

<p>C3 BOX</p> <p>Gas / Electric & Electric / Electric</p> <p>240H 20 Ton</p> <p>300S 25 Ton</p> <p>300H 25 Ton</p>	<p>Condenser Fans</p> <div style="display: flex; justify-content: space-around;"> <div style="text-align: center;">  <p>4 (B22) OFF</p> </div> <div style="text-align: center;">  <p>1 (B4) OFF</p> </div> </div> <p>B13 or B20 - A178 - J397-2 B1 or B2 - A55 - J390-1</p>	
	<p>Condenser Fans</p> <div style="display: flex; justify-content: space-around;"> <div style="text-align: center;">  <p>5 (B23) OFF</p> </div> <div style="text-align: center;">  <p>2 (B5) OFF</p> </div> </div> <p>B13 or B20 - A178 - J397-2 B1 or B2 - A55 - J390-1</p>	
<p>Compressors</p> <div style="display: flex; justify-content: space-around;"> <div style="text-align: center;">  <p>B1</p> </div> <div style="text-align: center;">  <p>B2</p> </div> <div style="text-align: center;">  <p>B13</p> </div> <div style="text-align: center;">  <p>B20</p> </div> </div> <p>A55-K1 A55-K2 A178-K14 A178-K146</p>	<div style="text-align: center;">  <p>6 (B24) SLT</p> </div> <p>B13 or B20 - A178 - J403-2</p>	<div style="text-align: center;">  <p>(3) B21 SLT</p> </div> <p>B1 or B2 - A55 - J381-5</p>

10.6.11. D Box LGT, LCT 302H, 360H

Table 51. Low Ambient Outdoor Fan Control and Cycling - D Box

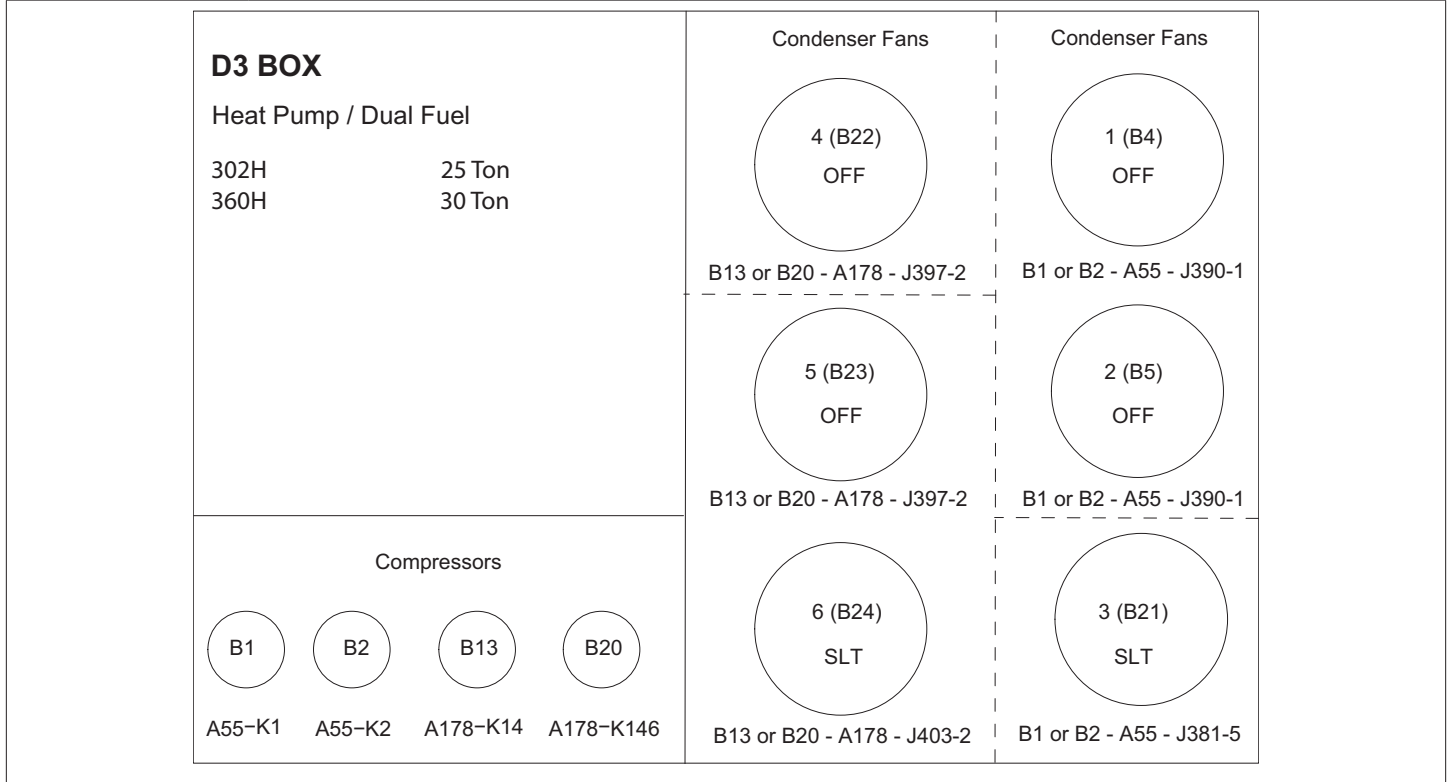
Models	Fan	Associated Compressor	Entry is OAT < 55°F and exit is OAT >=58°F for all models (see parameter 84)
LGT, LCT 302H, 360H	B4	B1, B2	B4 - OFF
	B5	B1, B2	B5 - OFF
	B21	B1, B2	B21 - OFF/MIN SPEED/Modulate depending on Saturated Liquid Temperature (SLT) value/history
	B22	B13, B20	B22 - OFF
	B23	B13, B20	B23 - OFF
	B24	B13, B20	B24 - OFF/MIN SPEED/Modulate depending on Saturated Liquid Temperature (SLT) value/history

<p>D BOX</p> <p>Gas / Electric & Electric / Electric</p> <p>302H 25 Ton</p> <p>360H 30 Ton</p>	<p>Condenser Fans</p>	
	<p>4 (B22) OFF</p> <p>B13 or B20 - A178 - J397-2</p>	<p>1 (B4) OFF</p> <p>B1 or B2 - A55 - J390-1</p>
	<p>5 (B23) OFF</p> <p>B13 or B20 - A178 - J397-2</p>	<p>2 (B5) OFF</p> <p>B1 or B2 - A55 - J390-1</p>
<p>Compressors</p> <p>B1 B2 B13 B20</p> <p>A55-K1 A55-K2 A178-K14 A178-K146</p>	<p>6 (B24) SLT</p> <p>B13 or B20 - A178 - J403-2</p>	<p>(3) B21 SLT</p> <p>B1 or B2 - A55 - J381-5</p>

10.6.12.D Box LGT, LCT 302H, 360H

Table 52. Low Ambient Outdoor Fan Control and Cycling - D Box

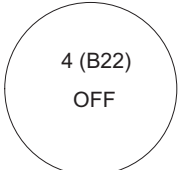
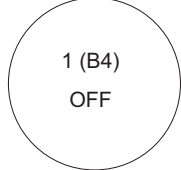
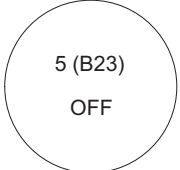
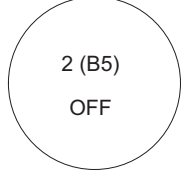




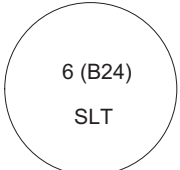
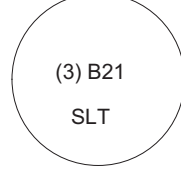
Models	Fan	Associated Compressor	Entry is OAT < 55°F and exit is OAT >=58°F for all models (see parameter 84)
LGT, LCT 302H, 360H	B4	B1, B2	B4 - OFF
	B5	B1, B2	B5 - OFF
	B21	B1, B2	B21 - OFF/MIN SPEED/Modulate depending on Saturated Liquid Temperature (SLT) value/history
	B22	B13, B20	B22 - OFF
	B23	B13, B20	B23 - OFF
	B24	B13, B20	B24 - OFF/MIN SPEED/Modulate depending on Saturated Liquid Temperature (SLT) value/history



10.6.13.D Box LGT, LCT 302H and 360H


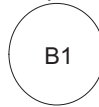

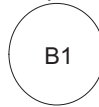

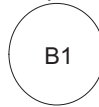

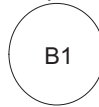

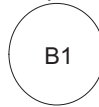

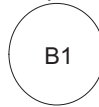
Table 53. Low Ambient Outdoor Fan Control and Cycling - D Box

Models	Fan	Associated Compressor	Entry is OAT < 55°F and exit is OAT >=58°F for all models (see parameter 84)
LGT, LCT 302H and 360H	B4	B1, B2	B4 - OFF
	B5	B1, B2	B5 - OFF
	B21	B1, B2	B21 - OFF/MIN SPEED/Modulate depending on Saturated Liquid Temperature (SLT) value/history
	B22	B13, B20	B22 - OFF
	B23	B13, B20	B23 - OFF
	B24	B13, B20	B24 - OFF/MIN SPEED/Modulate depending on Saturated Liquid Temperature (SLT) value/history

<p>D BOX</p> <p>Gas / Electric & Electric / Electric</p> <p>302H 25 Ton</p> <p>360H 30 Ton</p>	<p>Condenser Fans</p> <div style="display: flex; justify-content: space-around;"> <div style="text-align: center;">  <p>4 (B22) OFF</p> </div> <div style="text-align: center;">  <p>1 (B4) OFF</p> </div> </div> <p>B13 or B20 - A178 - J397-2 B1 or B2 - A55 - J390-1</p>	
	<div style="display: flex; justify-content: space-around;"> <div style="text-align: center;">  <p>5 (B23) OFF</p> </div> <div style="text-align: center;">  <p>2 (B5) OFF</p> </div> </div> <p>B13 or B20 - A178 - J397-2 B1 or B2 - A55 - J390-1</p>	
<p>Compressors</p> <div style="display: flex; justify-content: space-around;"> <div style="text-align: center;">  <p>B1</p> </div> <div style="text-align: center;">  <p>B2</p> </div> <div style="text-align: center;">  <p>B13</p> </div> <div style="text-align: center;">  <p>B20</p> </div> </div> <p>A55-K1 A55-K2 A178-K14 A178-K146</p>	<div style="display: flex; justify-content: space-around;"> <div style="text-align: center;">  <p>6 (B24) SLT</p> </div> <div style="text-align: center;">  <p>(3) B21 SLT</p> </div> </div> <p>B13 or B20 - A178 - J403-2 B1 or B2 - A55 - J381-5</p>	

























10.6.14.A Box LHT, LDT 024H, 036H, 048H, 060H, 072H

Table 54. Low Ambient Outdoor Fan Control and Cycling - A Box

Models	Fan	Associated Compressor	Entry is OAT < 55°F and exit is OAT >=58°F for all models (see parameter 84)																		
LHT, LDT 024H, 036H, 048H and 060H	B4	B1	B4 - OFF/MIN SPEED/Modulate depending on Saturated Liquid Temperature (SLT) value/history																		
<table border="1" style="width: 100%; border-collapse: collapse;"> <tr> <td style="width: 50%; vertical-align: top; padding: 5px;"> <p>A BOX</p> <p>Heat Pump</p> <table style="width: 100%; border: none;"> <tr> <td style="padding: 2px 10px 2px 20px;">024H</td> <td style="padding: 2px 10px 2px 20px;">2 Ton</td> </tr> <tr> <td style="padding: 2px 10px 2px 20px;">036H</td> <td style="padding: 2px 10px 2px 20px;">3 Ton</td> </tr> <tr> <td style="padding: 2px 10px 2px 20px;">048H</td> <td style="padding: 2px 10px 2px 20px;">4 Ton</td> </tr> <tr> <td style="padding: 2px 10px 2px 20px;">060H</td> <td style="padding: 2px 10px 2px 20px;">5 Ton</td> </tr> <tr> <td style="padding: 2px 10px 2px 20px;">072H</td> <td style="padding: 2px 10px 2px 20px;">6 Ton</td> </tr> </table> </td> <td style="width: 50%; vertical-align: top; padding: 5px;"> <table style="width: 100%; border: none;"> <tr> <td style="text-align: center;">Condenser Fan</td> </tr> <tr> <td style="text-align: center;">  </td> </tr> <tr> <td style="text-align: center;">B1 - A55 - J381-4</td> </tr> <tr> <td style="text-align: center;">Compressor</td> </tr> <tr> <td style="text-align: center;">  </td> </tr> <tr> <td style="text-align: center;">A55 - K1</td> </tr> </table> </td> </tr> </table>				<p>A BOX</p> <p>Heat Pump</p> <table style="width: 100%; border: none;"> <tr> <td style="padding: 2px 10px 2px 20px;">024H</td> <td style="padding: 2px 10px 2px 20px;">2 Ton</td> </tr> <tr> <td style="padding: 2px 10px 2px 20px;">036H</td> <td style="padding: 2px 10px 2px 20px;">3 Ton</td> </tr> <tr> <td style="padding: 2px 10px 2px 20px;">048H</td> <td style="padding: 2px 10px 2px 20px;">4 Ton</td> </tr> <tr> <td style="padding: 2px 10px 2px 20px;">060H</td> <td style="padding: 2px 10px 2px 20px;">5 Ton</td> </tr> <tr> <td style="padding: 2px 10px 2px 20px;">072H</td> <td style="padding: 2px 10px 2px 20px;">6 Ton</td> </tr> </table>	024H	2 Ton	036H	3 Ton	048H	4 Ton	060H	5 Ton	072H	6 Ton	<table style="width: 100%; border: none;"> <tr> <td style="text-align: center;">Condenser Fan</td> </tr> <tr> <td style="text-align: center;">  </td> </tr> <tr> <td style="text-align: center;">B1 - A55 - J381-4</td> </tr> <tr> <td style="text-align: center;">Compressor</td> </tr> <tr> <td style="text-align: center;">  </td> </tr> <tr> <td style="text-align: center;">A55 - K1</td> </tr> </table>	Condenser Fan		B1 - A55 - J381-4	Compressor		A55 - K1
<p>A BOX</p> <p>Heat Pump</p> <table style="width: 100%; border: none;"> <tr> <td style="padding: 2px 10px 2px 20px;">024H</td> <td style="padding: 2px 10px 2px 20px;">2 Ton</td> </tr> <tr> <td style="padding: 2px 10px 2px 20px;">036H</td> <td style="padding: 2px 10px 2px 20px;">3 Ton</td> </tr> <tr> <td style="padding: 2px 10px 2px 20px;">048H</td> <td style="padding: 2px 10px 2px 20px;">4 Ton</td> </tr> <tr> <td style="padding: 2px 10px 2px 20px;">060H</td> <td style="padding: 2px 10px 2px 20px;">5 Ton</td> </tr> <tr> <td style="padding: 2px 10px 2px 20px;">072H</td> <td style="padding: 2px 10px 2px 20px;">6 Ton</td> </tr> </table>	024H	2 Ton	036H	3 Ton	048H	4 Ton	060H	5 Ton	072H	6 Ton	<table style="width: 100%; border: none;"> <tr> <td style="text-align: center;">Condenser Fan</td> </tr> <tr> <td style="text-align: center;">  </td> </tr> <tr> <td style="text-align: center;">B1 - A55 - J381-4</td> </tr> <tr> <td style="text-align: center;">Compressor</td> </tr> <tr> <td style="text-align: center;">  </td> </tr> <tr> <td style="text-align: center;">A55 - K1</td> </tr> </table>	Condenser Fan		B1 - A55 - J381-4	Compressor		A55 - K1				
024H	2 Ton																				
036H	3 Ton																				
048H	4 Ton																				
060H	5 Ton																				
072H	6 Ton																				
Condenser Fan																					
																					
B1 - A55 - J381-4																					
Compressor																					
																					
A55 - K1																					

10.6.15.B Box LHT, LDT 078H, 092H, 102H, 120H




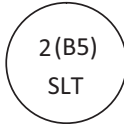
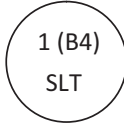
Table 55. Low Ambient Outdoor Fan Control and Cycling - B Box

Models	Fan	Associated Compressor	Entry is OAT < 55°F and exit is OAT >=58°F for all models (see parameter 84)																				
LHT, LDT 078H, 092H and 102H	B4	B1	B4 - OFF/MIN SPEED/Modulate depending on Saturated Liquid Temperature (SLT) value/history																				
	B5	B2	B5 - OFF/MIN SPEED/Modulate depending on Saturated Liquid Temperature (SLT) value/history																				
<table border="1" style="width: 100%; border-collapse: collapse;"> <tr> <td style="width: 50%; vertical-align: top; padding: 5px;"> <p>B BOX</p> <p>Heat Pump</p> <table style="width: 100%; border: none;"> <tr> <td style="padding: 2px 10px 2px 20px;">078H</td> <td style="padding: 2px 10px 2px 20px;">6 ½ Ton</td> </tr> <tr> <td style="padding: 2px 10px 2px 20px;">092H</td> <td style="padding: 2px 10px 2px 20px;">7 ½ Ton</td> </tr> <tr> <td style="padding: 2px 10px 2px 20px;">102H</td> <td style="padding: 2px 10px 2px 20px;">8 ½ Ton</td> </tr> <tr> <td style="padding: 2px 10px 2px 20px;">120H</td> <td style="padding: 2px 10px 2px 20px;">10 Ton</td> </tr> </table> </td> <td style="width: 50%; vertical-align: top; padding: 5px;"> <table style="width: 100%; border: none;"> <tr> <td style="text-align: center;">Condenser Fans</td> </tr> <tr> <td style="text-align: center;">  </td> </tr> <tr> <td style="text-align: center;">A55 - J381-5</td> </tr> <tr> <td style="text-align: center;">Compressors</td> </tr> <tr> <td style="text-align: center;">   </td> </tr> <tr> <td style="text-align: center;">A55-K1 A55-K2</td> </tr> </table> </td> </tr> <tr> <td colspan="2" style="vertical-align: top; padding: 5px;"> <table style="width: 100%; border: none;"> <tr> <td style="text-align: center;">  </td> </tr> <tr> <td style="text-align: center;">A55 - J381-4</td> </tr> </table> </td> </tr> </table>				<p>B BOX</p> <p>Heat Pump</p> <table style="width: 100%; border: none;"> <tr> <td style="padding: 2px 10px 2px 20px;">078H</td> <td style="padding: 2px 10px 2px 20px;">6 ½ Ton</td> </tr> <tr> <td style="padding: 2px 10px 2px 20px;">092H</td> <td style="padding: 2px 10px 2px 20px;">7 ½ Ton</td> </tr> <tr> <td style="padding: 2px 10px 2px 20px;">102H</td> <td style="padding: 2px 10px 2px 20px;">8 ½ Ton</td> </tr> <tr> <td style="padding: 2px 10px 2px 20px;">120H</td> <td style="padding: 2px 10px 2px 20px;">10 Ton</td> </tr> </table>	078H	6 ½ Ton	092H	7 ½ Ton	102H	8 ½ Ton	120H	10 Ton	<table style="width: 100%; border: none;"> <tr> <td style="text-align: center;">Condenser Fans</td> </tr> <tr> <td style="text-align: center;">  </td> </tr> <tr> <td style="text-align: center;">A55 - J381-5</td> </tr> <tr> <td style="text-align: center;">Compressors</td> </tr> <tr> <td style="text-align: center;">   </td> </tr> <tr> <td style="text-align: center;">A55-K1 A55-K2</td> </tr> </table>	Condenser Fans		A55 - J381-5	Compressors	 	A55-K1 A55-K2	<table style="width: 100%; border: none;"> <tr> <td style="text-align: center;">  </td> </tr> <tr> <td style="text-align: center;">A55 - J381-4</td> </tr> </table>			A55 - J381-4
<p>B BOX</p> <p>Heat Pump</p> <table style="width: 100%; border: none;"> <tr> <td style="padding: 2px 10px 2px 20px;">078H</td> <td style="padding: 2px 10px 2px 20px;">6 ½ Ton</td> </tr> <tr> <td style="padding: 2px 10px 2px 20px;">092H</td> <td style="padding: 2px 10px 2px 20px;">7 ½ Ton</td> </tr> <tr> <td style="padding: 2px 10px 2px 20px;">102H</td> <td style="padding: 2px 10px 2px 20px;">8 ½ Ton</td> </tr> <tr> <td style="padding: 2px 10px 2px 20px;">120H</td> <td style="padding: 2px 10px 2px 20px;">10 Ton</td> </tr> </table>	078H	6 ½ Ton	092H	7 ½ Ton	102H	8 ½ Ton	120H	10 Ton	<table style="width: 100%; border: none;"> <tr> <td style="text-align: center;">Condenser Fans</td> </tr> <tr> <td style="text-align: center;">  </td> </tr> <tr> <td style="text-align: center;">A55 - J381-5</td> </tr> <tr> <td style="text-align: center;">Compressors</td> </tr> <tr> <td style="text-align: center;">   </td> </tr> <tr> <td style="text-align: center;">A55-K1 A55-K2</td> </tr> </table>	Condenser Fans		A55 - J381-5	Compressors	 	A55-K1 A55-K2								
078H	6 ½ Ton																						
092H	7 ½ Ton																						
102H	8 ½ Ton																						
120H	10 Ton																						
Condenser Fans																							
																							
A55 - J381-5																							
Compressors																							
 																							
A55-K1 A55-K2																							
<table style="width: 100%; border: none;"> <tr> <td style="text-align: center;">  </td> </tr> <tr> <td style="text-align: center;">A55 - J381-4</td> </tr> </table>			A55 - J381-4																				
																							
A55 - J381-4																							

10.6.16.B2 Box LHT, LDT 122H and 150H

Table 56. Low Ambient Outdoor Fan Control and Cycling - B2 Box



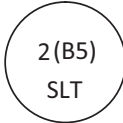
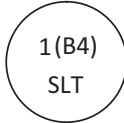


Models	Fan	Associated Compressor	Entry is OAT < 55°F and exit is OAT >=58°F for all models (see parameter 84)
LHT, LDT 122H and 150H	B4	B1	B4 - OFF/MIN SPEED/Modulate depending on Saturated Liquid Temperature (SLT) value/history
	B5	B2	B5 - OFF/MIN SPEED/Modulate depending on Saturated Liquid Temperature (SLT) value/history
	B21	B1, B2	B21 - OFF

<p>B2 BOX</p> <p>Heat Pump/Dual Fuel</p> <p>122H 10 Ton 150H 12.5 ton</p> <hr/> <p style="text-align: center;">Compressors</p> <div style="display: flex; justify-content: space-around;"> <div style="text-align: center;">  B1 A55-K1 </div> <div style="text-align: center;">  B2 A55-K2 </div> </div>	<p style="text-align: center;">Condenser Fans</p> <div style="display: flex; justify-content: space-around;"> <div style="text-align: center;">  3(B21) OFF A55 - J381-1 </div> <div style="text-align: center;">  2(B5) SLT A55 - J381-5 </div> </div> <hr style="width: 50%; margin: 10px auto;"/> <div style="display: flex; justify-content: space-around;"> <div style="text-align: center;">  1(B4) SLT A55 - J381-4 </div> </div>
--	--

10.6.17.B3 Box LHT, LDT 120H and 152H

Table 57. Low Ambient Outdoor Fan Control and Cycling - B3 Box

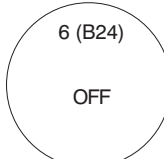
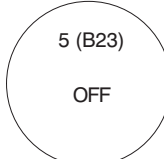

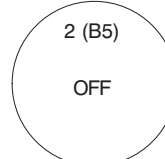


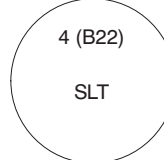
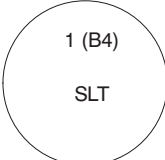
Models	Fan	Associated Compressor	Entry is OAT < 55°F and exit is OAT >=58°F for all models (see parameter 84)
LHT, LDT 120H and 152H	B4, B21	B1	B4, B21 - OFF/MIN SPEED/Modulate depending on Saturated Liquid Temperature (SLT) value/history
	B5, B22	B2	B5, B22 - OFF/MIN SPEED/Modulate depending on Saturated Liquid Temperature (SLT) value/history

<p>B3 BOX</p> <p>Heat Pump/Dual Fuel</p> <p>120H 10 Ton 152H 12.5 ton</p> <hr/> <p style="text-align: center;">Compressors</p> <div style="display: flex; justify-content: space-around;"> <div style="text-align: center;">  B1 A55-K1 </div> <div style="text-align: center;">  B2 A55-K2 </div> </div>	<p style="text-align: center;">Condenser Fans</p> <div style="display: flex; justify-content: space-around;"> <div style="text-align: center;">  2(B5) SLT A55 - J381-5 </div> <div style="text-align: center;">  1(B4) SLT A55 - J381-4 </div> </div> <hr style="width: 50%; margin: 10px auto;"/> <div style="display: flex; justify-content: space-around;"> <div style="text-align: center;">  4(B22) SLT A55 - J381-5 </div> <div style="text-align: center;">  3(B21) SLT A55 - J381-4 </div> </div>
--	--

10.6.18.C3 Box LHT, LDT 156H, 180H and 240H

Table 58. Low Ambient Outdoor Fan Control and Cycling - C3 Box

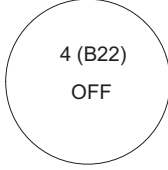
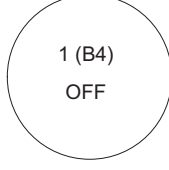
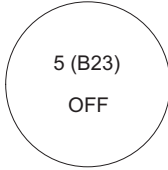
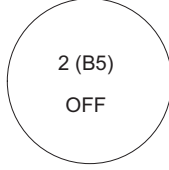




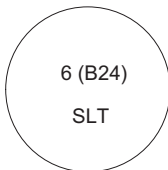
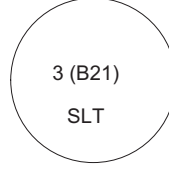
Models	Fan	Associated Compressor	Entry is OAT < 55°F and exit is OAT >=58°F for all models (see parameter 84)
LHT, LDT 156H, 180H and 240H	B4	B1	B4 - OFF/ON depending on Saturated Liquid Temperature (SLT) value/history
	B5	B1	B5 - OFF
	B21	B1	B21 - OFF
	B22	B2	B22 - OFF/ON depending on Saturated Liquid Temperature (SLT) value/history
	B23	B2	B23 - OFF
	B24	B2	B24 - OFF

<p>C3 BOX</p> <p>Heat Pump/Dual Fuel</p> <p>156H 13 Ton 180H 15 Ton 240H 20 Ton</p>	<p>Condenser Fans</p> <div style="text-align: center;">  <p>6 (B24) OFF</p> </div> <p>B2 - A178 - J397-2</p> <div style="text-align: center;">  <p>5 (B23) OFF</p> </div> <p>B2 - A178 - J397-2</p>	<p>Condenser Fans</p> <div style="text-align: center;">  <p>3 (B21) OFF</p> </div> <p>B1 - A55 - J390-2</p> <div style="text-align: center;">  <p>2 (B5) OFF</p> </div> <p>B1 - A55 - J390-2</p>
<p>Compressors</p> <div style="display: flex; justify-content: space-around; align-items: center;"> <div style="text-align: center;">  <p>B1 A55-K1</p> </div> <div style="text-align: center;">  <p>B2 A55-K2</p> </div> </div>	<div style="text-align: center;">  <p>4 (B22) SLT</p> </div> <p>B2 - A178 - J397-1</p>	<div style="text-align: center;">  <p>1 (B4) SLT</p> </div> <p>B1 - A55 - J390-1</p>

10.6.19.D Box LHT, LDT 302H, 360H

Table 59. Low Ambient Outdoor Fan Control and Cycling - C3 Box

Models	Fan	Associated Compressor	Entry is OAT < 55°F and exit is OAT >=58°F for all models (see parameter 84)
LHT, LDT 302H	B4	B1	B4 - OFF/ON depending on Saturated Liquid Temperature (SLT) value/history
	B5	B1	B5 - OFF
	B21	B1	B21 - OFF
	B22	B2	B22 - OFF/ON depending on Saturated Liquid Temperature (SLT) value/history
	B23	B2	B23 - OFF
	B24	B2	B24 - OFF

<p>D3 BOX</p> <p>Heat Pump / Dual Fuel</p> <p>302H 25 Ton</p> <p>360H 30 Ton</p>	<p>Condenser Fans</p> <div style="display: flex; justify-content: space-around;"> <div style="text-align: center;">  <p>4 (B22) OFF</p> </div> <div style="text-align: center;">  <p>1 (B4) OFF</p> </div> </div> <p>B13 or B20 - A178 - J397-2 B1 or B2 - A55 - J390-1</p>	
	<div style="display: flex; justify-content: space-around;"> <div style="text-align: center;">  <p>5 (B23) OFF</p> </div> <div style="text-align: center;">  <p>2 (B5) OFF</p> </div> </div> <p>B13 or B20 - A178 - J397-2 B1 or B2 - A55 - J390-1</p>	
	<p>Compressors</p> <div style="display: flex; justify-content: space-around;"> <div style="text-align: center;">  <p>B1</p> <p>A55-K1</p> </div> <div style="text-align: center;">  <p>B2</p> <p>A55-K2</p> </div> <div style="text-align: center;">  <p>B13</p> <p>A178-K14</p> </div> <div style="text-align: center;">  <p>B20</p> <p>A178-K146</p> </div> </div>	
	<div style="text-align: center;">  <p>6 (B24) SLT</p> </div> <p>B13 or B20 - A178 - J403-2</p>	<div style="text-align: center;">  <p>3 (B21) SLT</p> </div> <p>B1 or B2 - A55 - J381-5</p>

11. Dehumidification Operations

Dehumidification mode is a combination of cooling to dehumidify and heating to maintain space temperature. Humiditrol™+ units route hot discharge gas to a reheat coil downstream of the evaporator. Economizer operation is disabled during dehumidification operation.

NOTE: Humiditrol+ is not supported for all units configured with VAV blowers.

NOTE: Humiditrol+ is not supported for heat pump models.

11.1. Humiditrol+ Dehumidification Operation — (Humiditrol Reheat)

- When cooling demands are low, a relative humidity sensor reading above setpoint will energize the first-stage compressor and hot gas will be routed to the reheat coil. The setpoint is set with Parameter 106 or from the L Connection/BACnet networks.
- For Model L units in this mode, the variable speed compressor will modulate according to the measured relative humidity (analog RH sensor installed) or run at 100% (humidistat installed).
- For Model L units, the blower speed will modulate to maintain Saturated Suction Temperature on the evaporator coil.
- For Model L units in normal ambient conditions, the outdoor fans will modulate according to DAT.
- In units with multiple reheat circuits, the second compressor and a second reheat coil are activated if the desired relative humidity cannot be achieved in a reasonable time.
- Humiditrol+ dehumidification will de-energize when the relative humidity drops to Parameter 106 minus Parameter 107.

Go to **SETTINGS > RTU OPTION > EDIT PARAMETER = 106 or 107 (106 = DEHUMID SET POINT) and (107 = DEHUMID DEADBAND)**

- An optional relative humidity sensor is required.

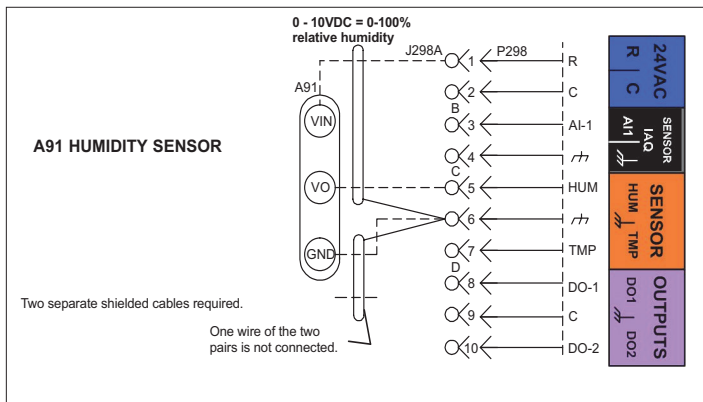


Figure 36. Relative Humidity Sensor Diagram

See paragraph 6.3. for further details concerning dehumidification setpoint.

Go to **RTU MENU > SETTINGS > RTU OPTIONS > EDIT PARAMETER = 105 (DEHUMID MODE)**

The following options show additional conditions that must be met before reheat will be energized.

11.1.1. Option 0 — No Reheat

No reheat.

11.1.2. Option 3 — Humiditrol+ Reheat Operation

- Blower energized
- Occupied time period

11.1.3. Option 4 — Relative Humidity Measurement

When an optional relative humidity sensor is installed, the relative humidity percentage can be displayed on the M4 unit controller and over the L Connection network via the network control panel or computer software client. *Option 4 is NOT used to control Humiditrol+ or Supermarket Reheat.*

11.1.4. Option 5 — Humiditrol+ Reheat Operation

One previous cooling demand must have occurred.

11.1.5. Option 6 — Humiditrol+ Reheat Operation

- Blower energized
- Occupied time period

11.1.6. Option 7 — Humiditrol+ Reheat

Humiditrol+ reheat with no additional conditions. This is the default setting for Model L units only.

11.1.7. Option 8 — Humiditrol+ reheat

Humiditrol+ will only operate if the unit is placed in an occupied state, even if the space humidity exceeds the setpoint.

11.2. Third Party Digital Input to Control Dehumidification

11.2.1. Method 1

Go to **RTU MENU > SETUP > INSTALL > CONFIGURATION ID1**

Set position 1 to **H** for Humiditrol+ option, then follow the wizard until sensor type option is prompted and select **REHEAT DI4**.

11.2.2. Method 2

Go to **RTU MENU > SETTINGS > RTU OPTIONS > DEHUMIDIFIER > SELECT DEHUMIDIFIER MODE**

For **SENSOR TYPE**, select **REHEAT DIGITAL INPUT 4**.

This method will only work if Configuration ID 1, position 1 is set correctly.

NOTE: *REHEAT DI4 is digital input 4 that is for Humiditrol+ or third-party products.*

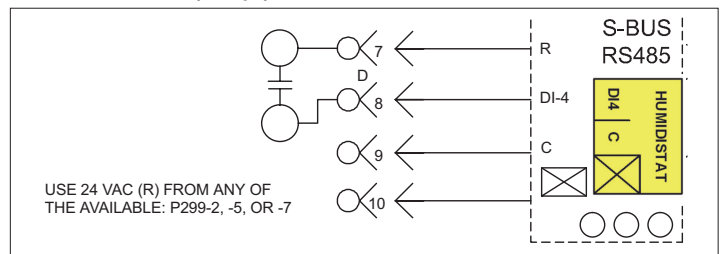


Figure 37. Reheat DI4 Diagram

12. Enhanced Dehumidification Operations

Model L and Strategos HP Ultra-High Efficiency units support Enhanced Dehumidification to help manage humidity levels efficiently. This is unique to Model L and Strategos HP units only.

Enhanced Dehumidification is supported on all single-zone Model L (LGM/LCM) units and does not require any additional options.

NOTE: *Enhanced Dehumidification is enabled by default on Humiditrol+ equipped units. It is disabled by default on units without Humiditrol+.*

12.1. Dehumidification in Wired Thermostat Mode

Enhanced Dehumidification mode is a means to remove humidity from the space without the use of a reheat system. To remove humidity in the space, the blower runs according to the normal cooling rules but with an adjusted cooling setpoint.

12.2. Enhanced Dehumidification in Room Sensor Mode

When in Enhanced Dehumidification mode, the unit operates the compressor, indoor blower, and outdoor fan with full variability to more accurately and efficiently match the humidity load in the space.

Even though Enhanced Dehumidification mode shifts the emphasis of unit operation from cooling to dehumidifying, some cooling of the air does take place as a side effect of the refrigeration system operating. Because the air is cooled it is possible to lower the temperature of the space below the space temperature setpoint while dehumidifying. This is known as “over-cooling” and is accounted for in the M4 unit controller by having an over-cool limit that is adjustable from 0°F - 6°F, default 2°F.

NOTE: *Units equipped with Hot-Gas Reheat (Humiditrol+) will not over-cool the space once the cooling demand is satisfied, and instead will initiate reheat dehumidification operation.*

The range for over-cool limit is also limited by Parameter 152, Automatic Changeover Deadband and the heating setpoint. Therefore, to set over cool limit to a value higher than two, user should first change Parameter 152 to “desired over-cool limit + 2”. Effective over-cool setpoint will be \geq heating setpoint + heating deadband + 1.

Set over cool limit to zero to avoid overcooling.

12.2.1. Enhanced Dehumidification without a Cooling Demand

Enhanced Dehumidification mode can be activated by the unit controller without a cooling demand being present. This is possible when the space humidity is higher than the space humidity setpoint but the space temperature is equal to or lower than the space temperature setpoint. In this scenario the M4 unit controller will operate the refrigeration system based on the humidity demand; allowing over-cooling of the space based on the over-cool limit setpoint.

To provide additional humidity removal when no cooling

demand is present, the M4 unit controller operates the indoor blower based on the over-cool limit setpoint and operates the compressor based on a programmed discharge air temperature setpoint designed for optimal moisture removal from the air. In this way, the indoor blower and compressor work together to achieve a higher latent capacity resulting in lower moisture content in the conditioned space.

The M4 unit controller will cease unit operation in Enhanced Dehumidification mode if either the humidity demand in the space is satisfied or the over-cool limit setpoint is satisfied, whichever comes first.

12.2.2. Enhanced Dehumidification with a Cooling Demand

Enhanced Dehumidification mode can also be activated by the M4 unit controller while a cooling demand is present. This is possible when the space humidity rises above the space humidity setpoint while the unit is already operating due to the space temperature being higher than the space temperature setpoint. In this scenario the M4 unit controller must determine if the cooling demand or the dehumidification demand is more urgent. Recall that, during a cooling demand, the unit controller modulates the blower based off the space temperature setpoint. Therefore, by realizing the speed of the indoor blower, the unit controller can determine the cooling demand of the space and decide if it is more urgent than the dehumidification demand. From the graph below one can see that the cooling demand is given precedence by the unit controller when the indoor blower speed is above 90% but the Enhanced Dehumidification mode demand is given precedence by the unit controller when the indoor blower speed is below 85%.

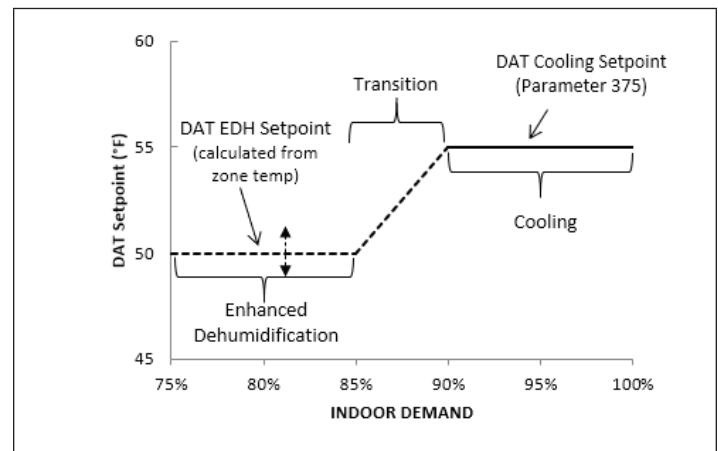


Figure 38. Modes of Operation

To provide additional humidity removal when Enhanced Dehumidification mode is given precedence, the unit controller operates the indoor blower based on the space temperature setpoint and operates the compressor based on a programmed discharge air temperature designed for optimal moisture removal from the air. The unit controller will cease unit operation in Enhanced Dehumidification mode if either the humidity demand in the space is satisfied or the over-cool limit setpoint is satisfied, whichever comes first. In the instance where the humidity demand is satisfied but the space temperature is still above the space temperature setpoint, the unit controller will transition unit operation back to cooling mode to satisfy the cooling demand. Enhanced Dehumidification with Relative Humidity Sensor

For units equipped with an analog relative humidity sensor, the controller may choose to operate the compressor based on the relative humidity and operate the compressor based on condenser coil temperature during Enhanced Dehumidification. This applies to both Thermostat and Room Sensor modes.

12.3. How to Enable or Disable Enhanced Dehumidification Mode

Go the RTU MENU > SETUP > INSTALL.

Follow the prompts until you reach **MODEL NUMBER**. Enter the Ultra-High Efficiency model number here. Touch **SAVE** to proceed. Continue through the various configuration items until you reach **DEHUM SENSOR TYPE**. By default it is set to **DISABLED**. **ENABLED** and select one of the following Enhanced Dehumidification mode sensor types:

- **LOCAL SENSOR** > DEHUMID SETPOINT > DEHUMID DEADBAND > OVERCOOL LIMIT
- **NETWORK SENSOR** > DEHUMID SETPOINT > DEHUMID DEADBAND > OVERCOOL LIMIT
- **REHEAT DI4**

Continue configuration until Enhanced Dehumidification Settings are reached. Use the slider to enable or disable Enhanced Dehumidification. If the unit is not equipped with Humiditrol+, users are prompted to select the dehumidification setpoint, deadband, and over-cool setpoints.

13. Power Exhaust Operations

The M4 unit controller is capable of controlling a factory or field installed Power Exhaust system, to exhaust excess air from the building envelope.

13.1. Enabling Feature

Power Exhaust is enabled through the configuration IDs. To enable the Power Exhaust feature, set Configuration ID 1 position 3 to N, S, or D. To enable the Economizer feature, set Configuration ID 1 position 2 to N, S, or D.

- **N** - No power exhaust installed
- **S** - Single stage power exhaust
- **D** - Dual stage power exhaust (Enlight models)

NOTE: The M4 unit controller disables Single & Dual stage Power Exhaust operation if the economizer is set to "Not Installed" or "Unconfigured."

13.2. Control

The M4 unit controller must also be configured to determine how the exhaust system is controlled. Configuration ID1 position 4 determines the control source.

- **A** - Power exhaust is operated based on damper position.
- **C** - Power exhaust is operated based on pressure transducer (A34).

Note 1 The power exhaust will be energized when enabled and the fresh air damper position reaches 50% travel (Parameter 215) when the blower is operating. The exhaust will de-energize when the damper position decreases 20% (Parameter 216) less than the setpoint or when the blower is de-energized.

Note 2 The power exhaust will be energized when enabled and the pressure is at or above Parameter 217. Power exhaust will de-energize when the pressure decreases by the dead-band set with Parameter 218.

Note 3 Stage one of power exhaust will be energized when enabled and the fresh air damper position reaches 50% Travel (Parameter 215). Stage two is energized when the fresh air damper position reaches (Parameter 219). Stage two will de-energize when the damper position drops below (set point - deadband). Stage 1 will not de-energize until stage two has been de-energized for 100 Seconds (Parameter 224).

Note 4 Stage one of power exhaust will be energized when enabled and the building pressure exceeds stage 1 setpoint (Parameter 217).

Stage two is energized when the building pressure exceeds stage 2 setpoint (Parameter 221). Stage two will de-energize when the building pressure drops below (set point - deadband). Stage 1 will not de-energize until stage two has been de-energized for 100 Seconds (Parameter 224).

Parameter 401 determines when the power exhaust is enabled.

- **0** - On when blower is energized
- **1** - On always
- **2** - On during occupied period

Table 60. Power Exhaust Configurations

Operation	Configuration ID 1 Setup
Single-stage power exhaust when A34 sensor is being used.	Setup config ID 1 to this value: NTSCNNNN Output: on.
Dual-stage power exhaust when A34 sensor is being used.	Setup config ID 1 to this value: NTDCNNNN Output: On/Off Input: A34 Value

13.3. Operation Based on Various Options

Table 61. Configuration ID 1 Character Position 4 - Power Exhaust Control

	Damper Position 'A'	Pressure Sensor A34 'C'
Single Stage 'S'	215 and 216 See Note 1 (above)	217 and 218 See Note 2 (above)
Dual Stage 'D'	215, 216, 219, 220, 223, and 224. See Note 3 (above)	217, 218, 221, 222, 223, and 224. See Note 4 (above).

14. Economizer Operations

14.1. General

The economizer, when configured, controls:

- Damper position, which determines how much outdoor air is used to meet free cooling or indoor air quality requirements, and
- Optional power exhaust fans.

On a cooling demand, if outdoor air is suitable, a combination of outdoor air and mechanical cooling (if needed) is used for free cooling.

14.2. Enabling Economizer and Settings

To enable the economizer go to **RTU MENU > SETUP > INSTALL** and follow the wizard instructions. Configuration ID 1, position 2 must be set to the applicable type of economizer. Valid types are as indicated below:

- **M** = Motorized Outdoor Air Damper Only
- **T** = Economizer - Temperature (**NOTE:** Used for both setpoint and offset temperature control.)
- **G** = Economizer - Global
- **S** = Economizer - Single Enthalpy
- **D** = Economizer - Dual Enthalpy

The following options are available depending on economizer set above. These settings are available through the main menu at:

Go to **SETUP > TEST & BALANCE > DAMPER**.

14.3. Damper Feedback Calibration and Minimum Damper Position

Go to **RTU MENU > SETUP > TEST & BALANCE > DAMPER > DAMPER CALIBRATION**

- Follow the guided instructions. The unit will drive the damper to the fully closed position. Visually inspect that the damper has stopped moving in the closed position and confirm in the app. Next the unit will drive the damper to fully open position. Visually inspect that the damper has stopped moving in the fully open position and confirm in the app.
- Next, the blower will be turned on and the minimum blower position during blower operation is set. If the unit is equipped for two blower speeds, set the minimum damper position for both High and Low blower speeds.

14.4. Damper Operation During Free Cooling

This is the operating profile option for the economizer damper (Parameter 164 - ECONOMIZER PROFILE) during free cooling when any compressor is on and can be selected as follows:

For Model L and Strategos HP Ultra High efficiency units (all sizes): only option 1 is allowed.

Option 1 - Damper opens to its maximum open position (Parameter 131 - FREE CL MAX DAMPER) when any compressors start.

For Enlight and Strategos Models (all sizes): Options 0-3 are allowed.

These are the operating profile options for the economizer damper during free cooling when any compressor is on and can be selected as follows:

- **Option 0:** Damper continues to modulate while compressors are on, but the effect of mechanical cooling may force the damper closed to its minimum position. After compressor starts, the free cooling setpoint is lowered to a fixed temperature of 45°F.
- **Option 1:** Damper opens to its max open position (Parameter 131 - FREE CL MAX DAMPER) when any compressors start.

NOTE: When using Option 1 and after the compressor is stopped, the CORE unit controller will resume damper modulation.

- **Option 2:** Damper continues to modulate while compressors are on, but the effect of mechanical cooling may force the damper closed to its minimum position. This is the factory default setting.
 - Holds off compressor on Y2 call until damper has modulated to maximum position (Parameter 131 - FREE CL MAX DAMPER) for three minutes.
 - After three minutes, compressor starts and the free cooling setpoint is lowered to 45°F. Damper is not locked at maximum open while compressor is on, but modulates to maintain 45°F discharge air temperature.
 - When Y2 is satisfied, compressor goes off and free cooling setpoint is restored to 55°F (Parameter 159 - FREE COOL SUPPLY SP).
- **Option 3:** Same as Option 2, but with a 10-minute delay instead of a three-minute delay.

14.5. Free Cooling Compressor Lockout Mode and Low Ambient Set Point

Go to **RTU MENU > SETTINGS > RTU OPTION > EDIT PARAMETER = 285 (FRCL COMP LCKOUT MD)**. Default value is 2. Range is 0 to 2.

- 0 = Disable compressor lockout
- 1 = Lockout compressor if outdoor air is suitable regardless of outdoor air temperature.
- 2 = Lockout compressor if outdoor air temperature is below Parameter 108 setting and outdoor air is suitable (default).

Go to **RTU MENU > SETTINGS > RTU OPTION > EDIT PARAMETER = 108 (FREE LO AMB LCKT SP)**.

Default value is 55.0°F. Range is 45.0 to 80.0°F.

14.6. Outdoor Air Suitable for Free Cooling

The M4 unit controller displays the outdoor air suitability information on the status screen.

The appropriate sensors are provided when the economizer is factory-configured. When the economizer is field-installed and configured, the single or dual enthalpy modes require additional field-provided sensor(s).

14.7. Enthalpy Set Point

This setting pertains to the single enthalpy free cooling mode only. The M4 unit controller will enable free cooling when outdoor air enthalpy (A7) is less than the enthalpy setpoint (Parameter 162 - ECON FREECL ENTH SP). Figure 8 shows the approximate enthalpy sensor output at various temperatures and percentage of relative humidity.

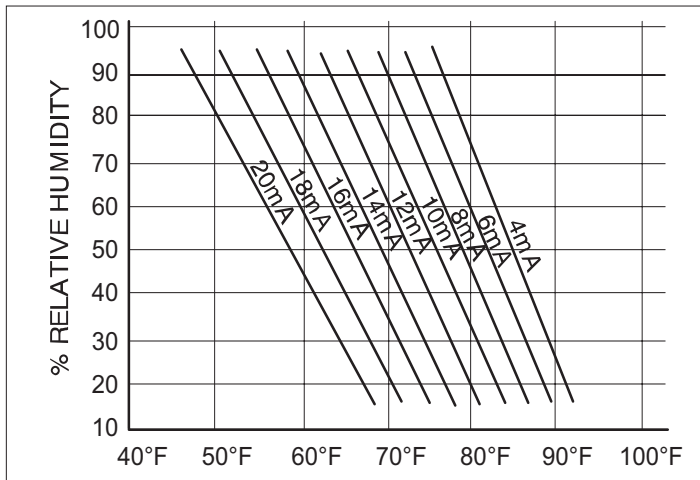


Figure 39. Enthalpy Sensor Output Current

14.8. Free Cooling Damper Maximum Position

Damper maximum position for free cooling is by default set to 100%. To modify this settings, use the following path:

RTU MENU > SETTINGS > RTU OPTION > EDIT PARAMETER - 131 (FREE CL MAX DAMPER)

14.9. Motorized Outdoor Air Damper

Set damper position according to “14.3. Damper Feedback Calibration and Minimum Damper Position” on page 74 . For normal operation, make sure the motorized outdoor air damper is set correctly in Configuration ID 1. Position 2 must to be set to M.

The damper will open to the specified position during the occupied time period and close during the unoccupied time period.

NOTE: When equipped with Motorized Outdoor Air Damper, M4 unit controller provides only Demand Control Ventilation. Free Cooling/Economizer function is not available.

14.10. Economizer Checkout

The following checkout procedures are completed with unit energized. Step 1 will determine whether the economizer is allowing full damper travel. Use step 2 when the damper does not respond to step 1.

Steps 3, 4, 5, and 6 checkout the operating modes. Checkout only the mode that applies to the unit being worked on.

CAUTION

Power exhaust fans will be functional. To prevent operation of power exhaust fans, disconnect power to unit and then PED jack/plug P/J18.

Step 1. ECONOMIZER OUTPUT VOLTAGE

The M4 unit controller monitors J384 (DPOS).

Go to RTU MENU > SERVICE > COMPONENT TEST > DAMPER > POSITION

- Start Test. The motor will slowly modulate to the closed position.
- Change DAMPER POSITION to 100.0%. The motor will slowly modulate to the fully opened position.
- If the motor does not respond, go to step 2. If the motor does respond properly, go to the appropriate mode of operation checkout.

Step 2. OUTPUT VOLTAGE CHECK

Go to RTU MENU > SERVICE > COMPONENT TEST > DAMPER > POSITION

- Adjust the DAMPER POSITION to 0.0% position.
- Measure the voltage on J384 between pin 2 (VOT damper control) and pin 9 (GND) using pin 8 as common. Voltage should read approximately 2 VDC.
- Adjust the DAMPER POSITION to 100.0% position.

NOTE: Allow approximately 90 seconds for actuator to react.

- Measure the voltage between J384 between pin 2 (VOT damper control) and pin 9 (GND) using pin 8 as common. Voltage should read approximately 10 volts DC. If not, check wiring and trouble shoot system.

Step 3. SINGLE ENTHALPY OPERATION (ODE)

In the single enthalpy mode, dampers open for free cooling when the outdoor enthalpy is less than the enthalpy setpoint (Parameter 162 - ECON FREECL ENTH SP); dampers will try to modulate discharge air temperature (RT6) to Parameter 159 - FREE COOL SUPPLY SP, which has a default setting of 55.0°F (13°C).

- Go to RTU MENU > SETUP > INSTALL > press **SAVE** until Configuration ID 1 displays. Position 2 must be set to **S** for Economizer Single Enthalpy and press **SAVE**.
- To simulate low outdoor enthalpy. Disconnect A7 outdoor enthalpy sensor jack/plugs J/P104. Connect a 750 ohm resistor across plug J104-1 and J104-2. J104 is located in the filter access area.
- Check all connections and wiring between J104 and the control.

Step 4. DUAL ENTHALPY MODE OF OPERATION

In dual enthalpy mode, dampers open for free cooling when the outdoor air enthalpy is lower than the return air enthalpy by difference value of Parameter 163 - ECN FRCL ENTH OFFST; dampers will modulate discharge air temperature (RT6) to Parameter 159 - FREE COOL SUPPLY SP, which has a default setting of 55.0°F (13°C).

- Go to RTU MENU > SETUP > INSTALL > press **SAVE** until the Configuration ID 1 displays. Position 2 must be

set to D for Economizer Dual Enthalpy. Press SAVE if performing an economizer field-install.

- Use two resistors to simulate outdoor air enthalpy suitable.
 - Disconnect A62 return air enthalpy sensor jack/plug J/P105. Place a 1500 ohm resistor between J105-1 and J105-3. J/P105 is located in the filter access area.
 - Disconnect A7 outdoor enthalpy sensor jack/plugs J/P104. Connect a 750 ohm resistor across J104-1 and J104-2.

Step 5. ALL TEMPERATURE MODES OF OPERATION

In the Economizer – Temperature mode, the damper opens for free cooling when the outdoor air temperature is:

- Less than return air temperature by at least a difference of (Parameter 161 - ECON FRCL TMP OFFST) if Temperature Offset mode is selected
- Less than Parameter 160 - ECON FREECL TEMP SP

In all modes, dampers will try to modulate discharge air temperature (RT6) to Parameter 159 - FREE COOL SUPPLY SP, which has a default setting of 55.0°F (13°C).

Select a resistor value that corresponds to a temperature (see “Table 62. TMP Mode Resistor Values”):

- Locate RT17 sensor in unit. Disconnect 1/4” quick connect terminals on wires leading from sensor.
- Jumper RT17 wires leading back to control with the appropriate resistor.
- Check all connections and wiring between RT17 and the M4 unit controller, and between RT16 and the M4 unit controller.

Table 62. TMP Mode Resistor Values

Temp. °F (°C)	Resistor Size	Temp. °F (°C)	Resistor Size	Temp. °F (°C)	Resistor Size	Temp. °F (°C)	Resistor Size
30 (-1.1)	34,566	50 (10)	19,904	70 (21)	11,884	90 (32)	7,332
40 (4.4)	26,106	60 (16)	15,313	80 (27)	9,298	100 (38)	5,826

Step 6. GLOBAL MODULATING (GLO) MODE OF OPERATION

In the GLO (modulating) mode, dampers modulate open for free cooling when the global input is energized; dampers will try to modulate discharge air temperature (RT6) to (Parameter 159 - FREE COOL SUPPLY SP) which has a default setting of 55.0°F (13°C).

NOTE: The global input turns on the blower.

- Set global mode using the Configuration ID 1, position 2, and set to character G.
- Connect a jumper between A55_P297-1 (24VAC) and A55_P297-9 (global). The blower will be energized and the damper will slowly open if discharge air temperature

(RT6) is greater than Parameter 159 - FREE COOL SUPPLY SP, which has a default setting of 55.0°F (13°C).

- Disconnect 24VAC to A55_P297-9. The blower will turn off and the damper will close.
- If the damper does not actuate check all connections and wiring between J384A and B.

Step 7. ENTHALPY SENSOR OPERATION (A7 and A62)

- Connect a direct current ammeter as shown in the following figure to measure current output of A7 or A62.

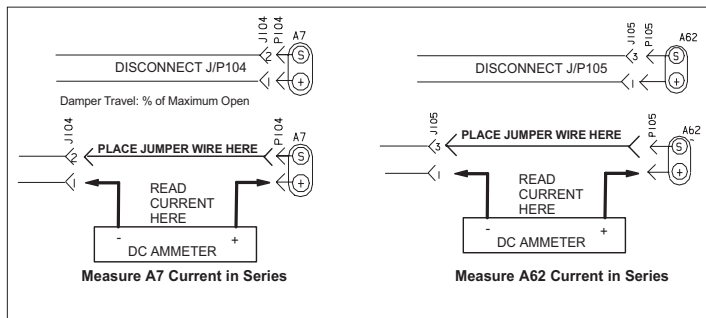


Figure 40. Measure A7 and A62 Current in Series

NOTE: If Enthalpy Sensors are configured, current sensor reading by M4 controller can be verified on user interface:

- The reading will be between 4 and 20 ma. Depending on outdoor temperature and humidity.

Go to RTU MENU > DATA > SYSTEM DATA/SENSOR /OUTPUT > INPUT AND OUTPUTS > LOCAL INPUTS > SENSORS (scroll down to IE: x.x mA and OE: x.x mA)

- If the meter reads zero, check sensor wiring harness for continuity and/or check polarity of sensor wiring.

15. Demand Control Ventilation (DCV) Operations

15.1. General

A field-provided and installed indoor air quality (IAQ) sensor can be used with the modulating economizer or motorized outdoor air damper (MOAD) to control carbon dioxide levels in the conditioned space. The carbon dioxide level in a space is an indicator of the number of people occupying a room. As the carbon dioxide level rises (indicating the occupancy of a room has increased), dampers modulate open - regardless of outdoor air suitability. Likewise, as the carbon dioxide level falls (indicating the occupancy has decreased), dampers modulate further closed.

Standard economizer installations have a minimum fresh air ventilation requirement based on maximum room occupancy. With standard economizer use, the amount of air required for maximum room occupancy is heated or cooled with each heating or cooling cycle. IAQ installations use the maximum amount of required ventilation air only with maximum room occupancy; less outdoor air needs to be heated or cooled when fewer people are in the conditioned space.

If the economizer is operating in the free cooling mode and the indoor air quality control requires the damper to open further, the indoor air quality demand will override the free cooling demand.

The IAQ function is not energized during the unoccupied or night time period.

NOTE: The IAQ sensor may also be used with systems containing a motorized outdoor air damper.

15.2. Default Operation

The M4 unit controller has a 0-10 VDC indoor air quality input for a standard 0 - 2000 ppm carbon dioxide sensor. The economizer starts opening at a carbon dioxide level of 700 ppm (default) (start open setpoint) and reaches full open at a carbon dioxide level of 1200 ppm (default) (full open setpoint).

The damper opens to a default position of 50% (see Parameter 117). Determine damper travel position using the following formula.

$$\% \text{ Damper Travel} = \left(\text{CO}_2 - \text{start open} \right) \frac{\text{max damper position}}{(\text{full open} - \text{start open})}$$

- CO2 - measured value, units:ppm
- Max Damper Position - parameter:117, units: % (default 50%)
- Start Open - parameter: 118, units: ppm (default 700 ppm)
- Full Open - parameter: 119, units: ppm (default 1200 ppm)

Example: At a carbon dioxide level of 950ppm, the damper will be approximately 25% open.

$$\% \text{ Damper Travel} = \left(950 \text{ ppm} - 700 \text{ ppm} \right) \frac{50\%}{(1200 - 700)} = 25\%$$

Use the applicable menu interface to read carbon dioxide ppm.

RTU MENU > DATA > SYSTEM DATA / SENSORS / OUTPUTS > LOCAL INPUTS > SENSORS > IAQ/CO2

RTU MENU > DATA > SYSTEM DATA / SENSORS / OUTPUTS > NETWORK INPUTS > INPUTS > CO2

15.3. Maximum and Minimum Demand Control Ventilation Damper Settings

Maximum position is set using the following menu path:

Go to RTU MENU > SETTINGS > RTU OPTIONS > DAMPER (then a series of questions)

Options are:

- DEMAND CONTROL VENT > DAMPER START OPEN = XXXX PPM
- DEMAND CONTROL VENT > DAMPER FULL OPEN = XXXX PPM
- DEMAND CONTROL VENT > DAMPER MAX OPENING = XXX.X %.

The maximum damper position depends on the outdoor air temperature. If the outdoor air temperature is too high or too low, the max position is reduced or even closed depending on outdoor air temperature relative to parameters 120-123.

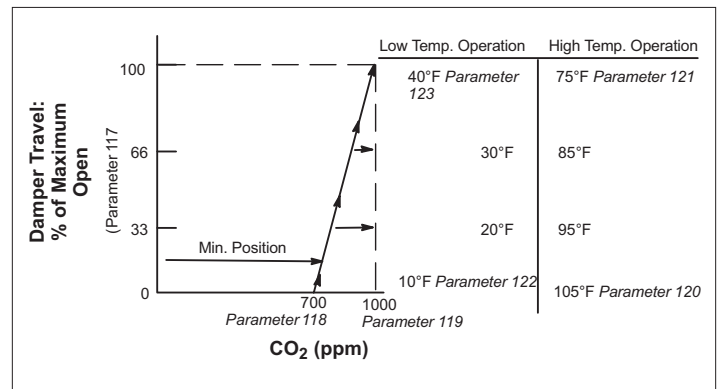


Figure 41. Default Demand Control Ventilation (DCV) Operation

15.4. Parameter Adjustments

Default indoor air quality economizer operation is based on common or average applications. Adjustments may be made to the indoor air quality Parameters to alter operation or meet required specifications. Use the user interface to change Parameter 117 through 123.

Go to SETTINGS > RTU OPTIONS > EDIT PARAMETER

Select a demand control ventilation mode with Parameter 134. Modes 3 and 4 will bring on the unit blower when demand control ventilation calls for maximum damper open, and returns to auto-blower when demand control ventilation damper returns to 0. The other modes only operate when the unit blower is on, but will not bring it on themselves.

Some applications require a different carbon dioxide setpoint range than default settings. Damper start open (Parameter 118) and full open (Parameter 119) carbon dioxide setpoints may be adjusted from 0 to 2000 ppm.

Use the following formula to determine damper travel.

NOTE: When changing carbon dioxide setpoint range, “start open” setpoint should be less than “full-open” setpoint.

$$\% \text{ Damper Travel} = \frac{[(\text{carbon dioxide ppm} - \text{Start Open ppm}) / (\text{Full Open ppm} - \text{Start Open ppm})] \times \text{Max Open \%}}{}$$

Example: An application requires the dampers open at 800 CO₂ ppm and reach full open at 1200. If the carbon dioxide level in the space reads 1000 ppm, calculate the damper percent open as follows.

$$\% \text{ Damper Travel} = 1000 - 800 / 1200 - 800 = 200 / 400 = 1/2$$

$$1/2 \times 100\% = \mathbf{50\%}$$

15.4.1. Set Point Control Option

Setpoint control mode is commonly used in areas with high occupancy and frequent change out such as classrooms or conference rooms.

In applications requiring this on/off damper response to carbon dioxide levels, set the start open (Parameter 118 - DCV DAMP START OPEN) setpoint higher than the full open (Parameter 119 - DCV DAMP FULL OPEN) setpoint. The dampers will drive to fully-open position immediately. Figure 11 shows the setpoint control option.

Change Parameters 122 and 123 to set the minimum outdoor temperature limits. Change Parameters 120 and 121 to set the maximum temperature limits.

IMPORTANT

Mixed air temperatures less than 45°F (7°C) on units with an aluminized heat exchanger or less than 30°F (-1°C) on stainless steel heat exchangers will void the manufacturer’s warranty.

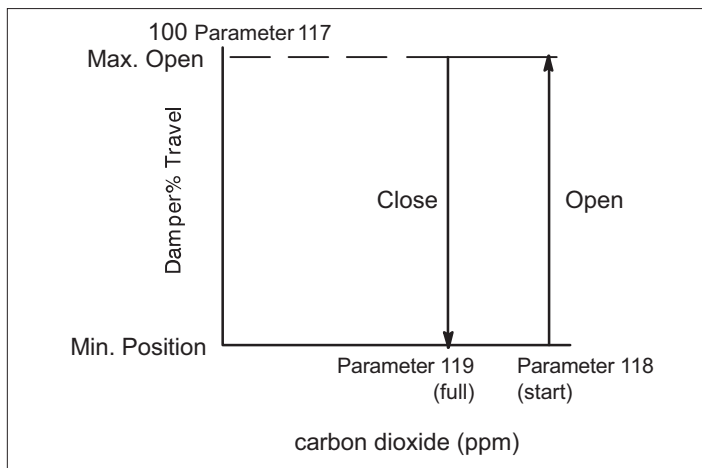


Figure 42. Set Point Control Indoor Air Quality Option

15.4.2. Determining Indoor Air Quality Inputs

Go to **DATA> IN/OUTPUTS > SENSORS** menu selection from the M4 unit controller menu display.

16. Outdoor Air Control (OAC) Operations

NOTE: This feature is not applicable to all Strategos units.

Outdoor air control is an alternative to demand control ventilation for modulating the outdoor air damper in order to hold a constant outdoor airflow. Outdoor Air Control mode requires an installed and functional A24 Air Flow Velocity Sensor (96M09) connected to the M4 unit controller IAQ input (P298-3).

NOTE: There are two versions of the A24 Air Flow Velocity Sensor, the original and latest version. See “Table 63. A24 Velocity Sensor Settings (100501-01)” and “Table 64. A24 Velocity Sensor Settings (100501-02)”.

In OAC mode, the M4 unit controller closes the damper as voltage increases to maintain a constant amount of fresh air. The sensor will read 10VDC at maximum flow and 0VDC at minimum flow.

NOTE: When the blower is off, the outdoor air damper will always be closed.

a. The OAC CFM option allows variable air volume units to minimize the effect of supply-fan speed modifications and maintains a constant outdoor air CFM level. The A24 sensor will need to be located in the outdoor air section of the unit. There it measures the outdoor air velocity and relays the information to the M4 unit controller. Based on the velocity information, the M4 unit controller automatically adjusts the economizer position, offsetting the supply-fan speed modifications and maintaining a constant outdoor air CFM level.

b. To enable the outdoor air control feature from the M4 unit controller interface.

Go to RTU MENU > SETUP > INSTALL

Navigate through the various settings until the screen for Configuration ID 1 displays. Position 8 must be set to one of the following options, which is dependent on the version of the sensor installed:

Table 63. A24 Velocity Sensor Settings (100501-01)

Configuration ID 1, Position 8	Speed	Description	Velocity
L	Low	Outdoor air control installed with A24 sensor set for low, medium or high ranges.	0 - 1000 ft / min.
M	Medium		0 - 1500 ft / min.
H	High		0 - 2000 ft / min.

V+ - 24VAC
GND - Common
AV - Airflow Output (0 - 10 VDC)

NOTE: The A24 velocity sensor has 0-10VDC output range that corresponds to the three range settings reference above. The A24 sensor (100501-01) is factory set for 0 - 1000 ft/min. If a higher velocity is required, the A24 sensor jumper will also need to be changed.

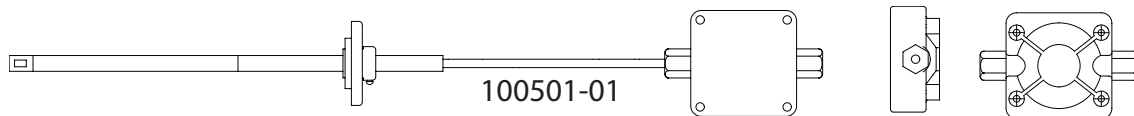


Table 64. A24 Velocity Sensor Settings (100501-02)

Configuration ID 1, Position 8	Speed	Description	Velocity	
H	High	<ul style="list-style-type: none"> Outdoor air control installed with A24 sensor set for high only. A24 sensor must be set to low when Configuration ID 1, position 8 is set to "H". This is the only combination of CONFIGURATION ID 1 and sensor settings that can be used with the 100501-02 sensor. 	0 - 2000 ft / min.	<p>OUTDOOR AIR VELOCITY SENSOR (A24) JUMPER SETTINGS</p>
<p>100501-02</p>				
<p>NOTE: A24 sensor (100501-02) is factory set for 0 - 2000 ft/min and does not required any sensor jumper adjustments.</p>				

c. To setup OAC after installing the velocity sensor, use the M4 unit controller menu.

Go to RTU MENU > SETUP > TEST & BALANCE > MIN DAMPER POSITION

Adjust the minimum damper position with the blower on high for the proper CFM reading. When saving that setting, the velocity sensor reading will be saved automatically as the velocity setpoint.

Go to RTU MENU > SETUP > TEST & BALANCE > OUTDOOR AIR CONTROL VELOCITY SETPOINT = XXX FT/MIN

d. **100501-01 only:** If the reading seen at the OUTDOOR AIR CONTROL VELOCITY SETPOINT is close to the limits of that range, go to the next velocity range M or H.

e. **100501-01 only:** If a different Velocity Range is required, redo steps A through C. The L, M, or H set at the Configuration ID 1 - position 8 must match the jumper setting on the 100501-01 sensor.

NOTE: The minimum damper position setting must be set less than the OAC max damper position setting for the damper to modulate during Outdoor Air Control. The default setting for the maximum OAC damper

position is 50%. To modify this setting, navigate to **SETTINGS > EDIT PARAMETER** and choose Parameter 117 (DCV MAX DAMPER OPEN).

f. **100501-02 only:** When using a -02 sensor, the CONFIGURATION ID must be set to "H". This corresponds to the sensor jumper being placed in the "low" position. No other combinations can be used. See "Table 66. Variable Frequency Drive Control" on page 82.

The M4 unit controller will modulate the outdoor air damper based on settings configured using Parameters 126 through 130 and Parameter 134 in order to maintain a constant airflow.

17. Building Pressure Control (BPC) Operations

The M4 unit controller supports building pressure control of ventilation. This feature modulates the outdoor air damper in order to hold a constant building pressure. This mode requires an A34 building pressure sensor installation on M4 unit controller IAQ input (instead of CO₂ sensor).

The Building Pressure Control option provides the ability to maintain a constant building pressure. A building pressure (A34) sensor located in the outdoor air section of the unit measures the difference between the outdoor and indoor (building) pressure and relays the information to the M4 unit controller. Based on the pressure information, the unit controller automatically adjusts the damper position and maintains a constant building pressure.

To enable this feature:

Go to RTU MENU > SETTINGS > RTU OPTIONS > DAMPER > DAMPER CONTROL VENTILATION OPTIONS and select BLDNG PRESS CTRL > PRESSURE SETPOINT = X.X IN H2O

See Parameters 134 and 327 through 329 for additional settings (see “Table 77. CORE Control System Unit Parameters” on page 140).

- **Alarm 103** - is raised if the BPC is enabled and the power exhaust control type is “C”.

18. Supply Air Delivery Operations

18.1. Blower Delays

The following is a summary of blower delay options, For more details refer to “8.3.7. Blower On-Delay” and “8.3.8. Blower Off-Delay” on page 47.

18.1.1. Gas Heat Operation

The default blower on delay is 40 seconds (Parameter 66 HT GAS BLR ON DELAY) after the gas valve is energized, and the default off delay is 120 seconds (Parameter 67 HT GAS BLR OFF DLAY) after the gas valve is de-energized. The blower operates anytime a heat limit trips.

18.1.2. Electric Heat Operation

The blower on delay default value is 0 seconds. The blower is delayed off by default for 20 seconds (Parameter 60 HT ELEC BL OFF DLAY) after the electrical heating is terminated.

18.1.3. HP Operation

The blower on delay default value is 0 seconds (Parameter 531 HT PUMP BL ON DLAY). The blower off delay default is 20 seconds (Parameter 532 HT PUMP BL OFF DLAY) after the mechanical heat is terminated.

18.1.4. Cooling Operation

The default on delay is 0, but may be adjusted by Parameter 79 (COOL BLR ON DELAY).The default off delay is 60 seconds, but may be adjusted by Parameter 80 (COOL

BLR OFF DELAY). The on delay time period starts when the cooling demand is initiated. The off delay time period starts when the cooling demand is terminated.”

18.2. Supply Multi-Stage Air Volume (MSAV) Control Mode

Units with Multi-Stage Air Volume are capable of delivering two or more stages/volumes of supply air. There are two blower types supported for Multi-Stage Air Volume:

- Belt driven blower with motors and external variable frequency drives – blower type M in model number.
- Direct driven blower using motors with integrated variable frequency control – blower type E in model number.

Refer to the unit Parameter label, installation instruction or service manual for details on percentage outputs and factory default CFM settings.

18.3. Supply Variable Air Volume (VAV) Control Mode

Blower speed is controlled by the M4 unit controller between a minimum and maximum speed to maintain duct static pressure setpoints. There are four different setpoints: one for cooling, one for ventilation, one for operation during smoke alarm modes, and one for heating. The M4 controls the duct static pressure by reading the duct pressure and varying the blower speed.

The minimum/maximum speed and static pressure setpoints are listed as follows:

Table 65. Minimum/ Maximum Speed and Static Pressure Set

Operation	Minimum Speed			Maximum Speed			Duct Static Setpoint		
	Para	Default	Range	Para	Default	Range	Para	Default	Range
Cooling	27	30%	25% - 100%	390	100%	40% - 100%	389	1.00" w.c.	0 - 5" w.c.
Ventilation	27	30%	25% - 100%	390	100%	40% - 100%	387	1.00" w.c.	0 - 5" w.c.
Smoke	27	30%	25% - 100%	390	100%	40% - 100%	386	1.00" w.c.	0 - 5" w.c.
Heating	28	30%	30% - 100%	390	100%	40% - 100%	388	1.00" w.c.	0 - 5" w.c.
Para = Parameter									

18.4. Variable Frequency Drive (VFD) Control

The M4 unit controller is only compatible with the factory installed variable frequency drives used to control the supply blower. The variable frequency drives are controlled via Modbus communication. This manual uses percent (%) for all blower and fan speeds.

EXAMPLE: Fifty percent blower speed equals 30Hz. Output frequency to the motor is displayed on the VFD seven-segment LEDs.

Table 66. Variable Frequency Drive Control

Speed %	Motor Frequency (Hz)
30	18
40	24
50	30
60	36
70	42
80	48
90	54
100	60

19. Analog Output Control Operations

The analog output on the M4 unit controller (P259-4) is set to closed loop PID or staged control when configured for constant air volume bypass damper (configuration ID 2, position 7 must be set to Y). The closed loop PID method used by the M4 unit controller has three constants and manual reset; proportional (P), integral (I) and derivative (D) as shown in the following figure. The PID control constants, as well as the output values for minimum and maximum, can be adjusted if necessary.

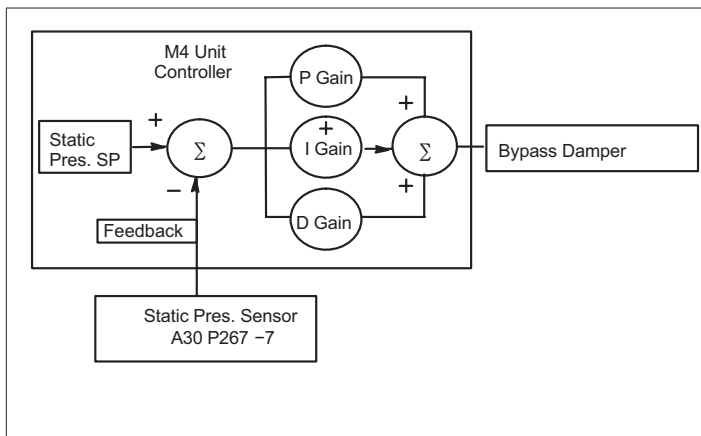


Figure 43. PID Operation Diagram for CAVB Air Delivery

19.1. Supply Manual Reset — Parameter 41

Supply Manual Reset is used when the output values for PID P, I, and D constant values are all set to 0 (OFF). This is the approximate output expected which allows quicker settling at setpoint. On constant air volume units with bypass damper, this is also the damper position when blower is off.

Supply Manual Reset can be adjusted between 20 to 100%. Default setting is 52%.

19.2. Supply Proportional Constant (P) — Parameter 31

To handle the present, this is the value of the “gain” that is multiplied times the error. The error is the difference between the output and the setpoint. A large value of “P” will cause the output to reach the setpoint faster, however, this faster rate can cause the output to overshoot the setpoint.

On the other hand, a low value of “P” will reduce overshoot, but will cause the output reaction to be too slow. The “P” constant parameter value can be adjusted between 0 –127 with 0 being off and 127 being the highest value.

19.3. Supply Integral Constant (I) — Parameter 32

To handle the past, this gain is proportional to the amount of time that the error is present. This gain tries to integrate out any offset. A high value of “I” can provide fast correction but can cause overshoot and ringing. The “I” gain should be set to the lowest value possible that corrects the offset. “I” can be adjusted between 0-127 with 127 being the lowest value. The “I” constant parameter value is inverted. A value of 0 turns the integral factor off. A value of 127 is the minimum and 1 is the maximum.

19.4. Supply Derivative Constant (D) — Parameter 33

To handle the future, this gain is proportional to the rate of change of the error and provides a damping factor. The “D” constant parameter value can be adjusted between 0-127 with 0 being off and 127 being the highest value. Most M4 unit controller applications do not require using any “D” gain.

19.5. Parameter Adjustments and Tuning Method

In the event that the PID loop requires tuning, the following two methods are recommended depending on the severity of the problem:

- Parameter Adjustment Method** - In most cases the parameters will only need a small adjustment. In that case use the following table as a basic guide.

Table 67. Tuning

Change Desired	Parameter 31 (PID P)	Parameter 32 (PID I)	Parameter 33 (PID D)
Reduce Response Time	Increase	Decrease	Decrease
Reduce Overshoot	Decrease	Increase	Increase
Reduce Settling Time		Decrease	Decrease
Reduce Offset (steady state error)	Increase	Decrease	

- Tuning Method** - If the parameter adjustment method does not stabilize the system, use the following tuning method:

NOTE: To use this method the system must be allowed to operate at the manual reset value (% output) without damaging the system.

- Step 1.** Set the Parameters 31, 32 and 33 blower PID constants to 0 (OFF).
- Step 2.** **Start system.** Analog output value will be at the Parameter 41 (SUPPLY MANUAL RESET) value (%).
- Step 3.** **Monitor system.** System should be stable. If system is not stable at this point check for other problems. Adjusting the PID Parameters will not solve this problem.
- Step 4.** If system is stable, gradually increase the Parameter 31 (SUPPLY PID P CONST) until system starts oscillating (moving above and below setpoint, continuously).
- Step 5.** Reduce the Parameter 31 (SUPPLY PID P CONST) to 40-70% of the value set in step 4.
- Step 6.** Gradually start adjusting Parameter 32 (SUPPLY PID I CONST) by setting to 127 and reduce setting until the steady state error (offset) is reduced to an acceptable level.
- Step 7.** If necessary, increase the Parameter 33 (SUPPLY PID D CONST) to reduce overshoot. Use of Parameter 33 (D) can increase settling time and/or lead to instability.

NOTE: It is recommended, and in most cases best, not to use Parameter 33 (SUPPLY PID D CONST).

19.6. Indoor Blower Auto Calibration (3 - 12.5 Ton Units Only)

Calibration is a procedure that determines the relationship between motor torque and supply airflow by collecting operational data from the system after it has been applied in the field and the appropriate filters are installed. The goal is to discover appropriate ECM blower motor speeds that correspond to various supply airflow targets.

Once installed, each unit will undergo a calibration process. Calibration starts automatically with the first blower demand received after 24 hours completion of the installation. Installer can also trigger the calibration manually through the display menu option. Calibration is a onetime process after the installation and once successful, calibration data will be retained in M4 unit controller until the calibration is re-triggered manually.

The user can change the supply airflow settings without re-triggering the calibration any time.

The below steps are sequentially carried out during the calibration process.

- a. Initialization:** All components in roof top units except for the blower are turned OFF. System will wait for outdoor air damper to close. Then the blower is run at minimum PWM setting of 20%.
- b. Blower Diagnostics:** Blower output speed is gradually increased in steps from 20% to 100%, with the step value set by Parameter 247 (Advanced Airflow Blower Ramp Rate Set Point). At each step output speed and calculated supply airflow are recorded internally to a calibration table. In applications where the supply static pressure is

high, blower calibration will stop once blower RPM has crossed the cutoff range (1250 rpm – for ECM motors) even before reaching 100%. In applications where the supply static is less, blower calibration will stop once the calculated supply airflow is greater than the RTU airflow specification of 480 CFM/ton. If the calculated supply static pressure is greater than 1.8” or less than 0.1”, the calibration process will fail.

19.7. Supply Airflow Measurement and Control

Based on the blower demand (heating, cooling, ventilation and smoke) the corresponding Parameters 12, 13, 14, 17 and 18 are chosen as target air flows. Using the linear interpolation method, the corresponding % output speed for the target airflow is calculated from the calibration table. The blower is then run based on these percentage output speeds.

20. Discharge Air Control Operations

20.1. Cooling

The discharge air control cooling option automatically cycles up to four stages of cooling to maintain a discharge air control cooling setpoint.

- When an economizer is installed, adjust free cooling setpoint Parameter 159 approximately two degrees lower than discharge air control cooling setpoint. This allows free cooling to operate before discharge air control cooling energizes compressors.
- Compressor operation and staging is the same as for normal cooling except that the Discharge Air Temperature setpoint is set via Parameters 180 (for occupied) and 181 (for unoccupied). See “Figure 34. Room Sensor Stages for Gas / Electric Units - Cooling (default values shown)” on page 41.
- Adjust Parameter 111 to option 4 to enable discharge air control cooling.

IMPORTANT

Discharge air sensor RT6 must be moved to the supply air duct, preferably after a 90 degree branch of the main duct.

Discharge Air Control Cooling is initiated by an input in one of three ways:

- Y input from an external device. If the M4 unit controller is configured for wired thermostat.

Go to RTU MENU > NETWORK INTEGRATION > NETWORK SETUP WIZARD> CHOOSE WIRED THERMOSTAT

- Cooling demand while in RTU STANDALONE mode:

Go to RTU MENU > SETUP > NETWORK INTEGRATION > NETWORK SETUP WIZARD > NETWORK = RTU STANDALONE > OCC BLOWER MODE => BACK UP MODE =>

NOTE: Continue to answer questions concerning heating and cooling setpoints.

- Cooling demand while in room sensor mode:

Go to RTU MENU > SETUP > NETWORK INTEGRATION > NETWORK INTEGRATION > NETWORK = (L CONNECTION, LONTALK OR BACNET) > any additional network settings > CONTROL MODE = ROOM SENSOR >

NOTE: Continue to answer questions concerning network sensor type, OCC blower mode and backup mode.

20.1.1. Discharge Air Control Cooling (DACC) Outdoor Air Temperature (OAT) Reset

IMPORTANT

Outdoor air reset can also be used to adjust Parameter 159 (FREE COOL SUPPLY SP) when Discharge Air Cooling Control is not used. All references to the Discharge Air Cooling Control setpoint apply to the free cooling setpoint.

The DACC OAT Reset and free cooling setpoint can be automatically reset when outdoor air temperature becomes cooler.

- For DACC OAT Reset, use Parameter 287 to enable DACC Outdoor Air Temperature Reset.
- For DACC OAT Reset, the discharge air cooling setpoint starts to increase when the outdoor air temperature drops to the Parameter 202 (DACC OAT RS ADJ SP) with a default of 80°F. The reset setpoint will continue to increase at the rate equal to the Parameter 201 (DACC OAT RS ADJ BND) divided by the Parameter 203 (DACC OAT RS PRP BND).

EXAMPLE: The application calls for the discharge air cooling occupied setpoint Parameter 180 to be 55°F when Outdoor Air Temperature is 80°F or higher. When the Outdoor Air Temperature drops below 80°F, the setpoint needs to increase proportionately with the Outdoor Air Temperature decrease (maximum setpoint increase of 10°F). The 10°F Outdoor Air Temperature decrease is called the Parameter 203 and the setpoint increase of 10°F is called the Parameter 201. See Figure 14.

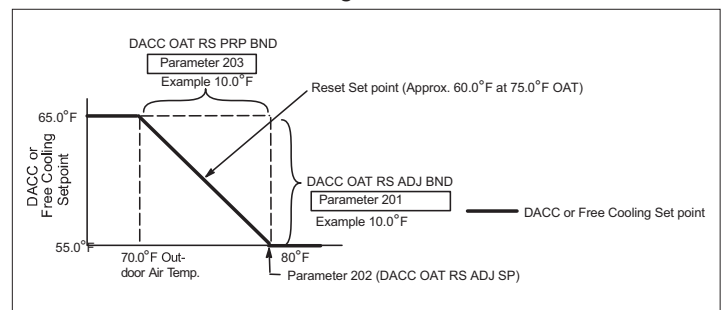


Figure 44. Outdoor Air Reset Example

To use example values, set the following Parameters:

- Parameter 201 – Set to 10.0°F (this setting is for Discharge Air Control Cooling Outdoor Air Temperature Adjustment Band)
- Parameter 202 – Set to 80.0°F (this setting is for Discharge Air Control Cooling Outdoor Air Temperature Cooling Reset Set Point)
- Parameter 203 – Set to 10.0°F (this setting is for Discharge Air Control Cooling Outdoor Ambient Air Temperature Cooling Proportional Band)

20.1.2. Discharge Air Control Cooling (DACC) Return Air Temperature (RAT) Reset

IMPORTANT

Return air reset can also be used to adjust Parameter 159 when Discharge Air Control Cooling is not used. All references to the Discharge Air Control Cooling setpoint apply to the free cooling setpoint.

The DACC RAT and free cooling setpoint can be automatically reset when outdoor air temperature becomes cooler.

- For DACC RAT Reset, use Parameter 287 to enable DACC RAT Reset.
- For DACC RAT Reset, the discharge air cooling setpoint starts to increase when the return air temperature drops to the Parameter 205 (DACC RAT RS ADJ SP) which has a default of 70.0°F. The reset setpoint will continue to increase at the rate equal to the Parameter 204 (DACC RAT RS ADJ BND) divided by the Parameter 206 (DACC RAT RS PRP BND).

EXAMPLE: The application calls for the discharge air occupied setpoint Parameter 180 to be 55.0°F when Return Air Temperature is 70.0°F or higher. When the Return Air Temperature drops below 70°F, the setpoint needs to increase proportionately with the Outdoor Air Temperature decrease (maximum setpoint increase of 10°F). The 10.0°F Return Air Temperature difference is called Parameter 203 and the setpoint increase of 10.0°F is called the Parameter 204.

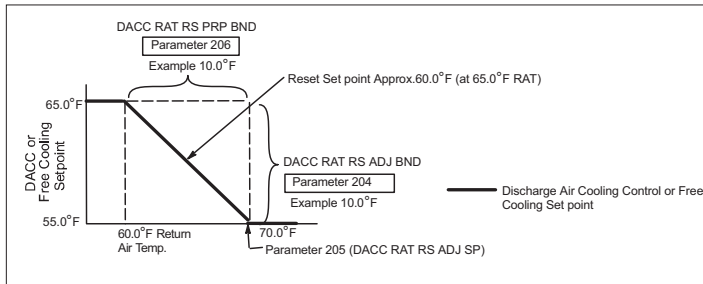


Figure 45. Return Air Reset Example

To use example values, set the following Parameters:

- Parameter 205 – Set to 70.0°F
- Parameter 206 – Set to 10.0°F
- Parameter 204 – Set to 10.0°F (this setting enables Discharge Air Control Cooling return air reset).

20.1.3. Discharge Air Control Cooling (DACC) Total Reset Limit

Parameter 207 with a default setting of 10.0°F defines the total Discharge Air Control Cooling setpoint reset limit. This total limit is the sum of both return and outdoor Discharge Air Control Cooling resets. This Parameter limits total DACC_SP adjustment band and overrides the adjustment bands for Parameter 201 and Parameter 204 if necessary.

20.2. Heating

The discharge air control heating option automatically cycles up to four-stages of heating to maintain a discharge air control heating setpoint.

- Discharge Air Control Heating option applies to gas/ electric and electric / electric units only.

- Refer to “Figure 46. Discharge Air Control Heating Stages - Default Values Shown” for Discharge Air Control Heating stages.
- Adjust Parameter 112 to 1 to enable discharge air control.

IMPORTANT

Discharge air sensor RT6 must be moved to the supply air duct, preferably after a 90 degree branch off of the main duct.

Discharge Air Control Heating is initiated by an input in one of three ways:

- W input from an external device if M4 unit controller is configured for wired thermostat mode.
- Heating demand while in zone sensor mode.
- Heating demand while in L-Connection room sensor mode.

NOTE: Additional Parameters can be set depending on selection choices.

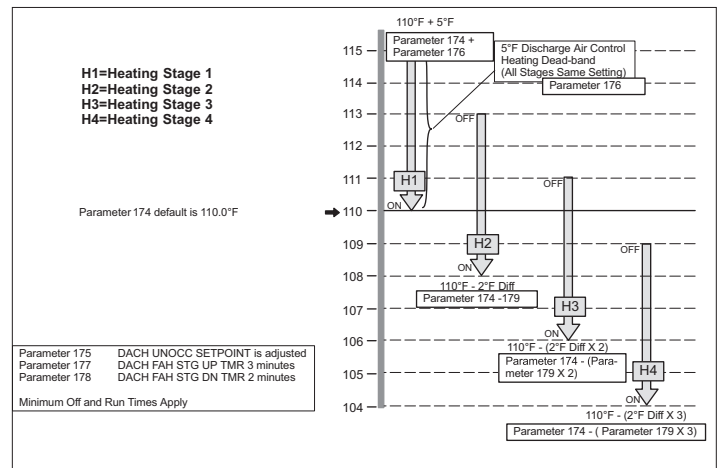


Figure 46. Discharge Air Control Heating Stages - Default Values Shown

20.2.1. Discharge Air Control Heating (DACH) Outdoor Air Temperature Reset

- Using the Lennox CORE Service App, access Parameter 287 and enable DACH Outdoor Air Reset.
- The Discharge Air Control Heating setpoint can be automatically reset when outdoor air temperature becomes warmer.
- For outdoor air based Discharge Air Control Heating setpoint reset, the discharge air control heating setpoint starts to decrease when the outdoor air temperature rises to Parameter 209 setpoint, which has a default of 40°F. The reset setpoint will continue to decrease at the rate equal to Parameter 208 divided by Parameter 210.

EXAMPLE: The application calls for the discharge air control heating occupied setpoint - Parameter 174 to be 110°F when outdoor air temperature is 40°F or lower. When the outdoor air temperature rises above 40°F, the setpoint needs to decrease proportionately with the outdoor air temperature increase (maximum setpoint increase of 10°F. The 10°F outdoor air temperature decrease is called Parameter 213 and the setpoint decrease of 10°F is called Parameter 211.

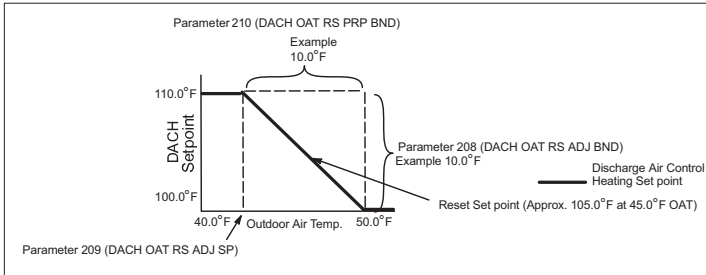


Figure 47. Outdoor Air Reset Example

To use example values, set the following Parameters:

- Parameter 208 – Set to 10.0°F (this setting enables Discharge Air Control Heating Outdoor Air Temperature Reset Adjustment Band)
- Parameter 209 – Set to 40.0°F (this setting enables Discharge Air Control Heating Outdoor Air Temperature Reset Adjustment Set Point)
- Parameter 210 – Set to 10.0°F (this setting enables Discharge Air Control Heating Outdoor Air Temperature Reset Proportional Band).

20.2.2. Discharge Air Control Heating (DACH) Return Air Temperature Reset

- Using the Lennox CORE Service App, access Parameter 287 and enable DACH Return Air Temperature Reset.
- The Discharge Air Control Heating setpoint can be automatically reset when return air temperature becomes warmer.
- For return air based Discharge Air Control Heating setpoint reset, the discharge air control heating setpoint starts to decrease when the return air temperature rises to the Parameter 212 that has a default setting of 70.0°F. The reset setpoint will continue to decrease at the rate equal to the Parameter 211 divided by the Parameter 213.

EXAMPLE: The application calls for the discharge air control heating occupied setpoint Parameter 174 to be 110.0°F when Return Air Temperature is 70.0°F or lower. When the Return Air Temperature increases above 70.0°F, the setpoint needs to decrease proportionately with the Return Air Temperature increase (maximum setpoint increase of 10.0°F). The 10.0°F Return Air Temperature difference is called the Parameter 213 and the setpoint increase of 10.0°F is called Parameter 204. See the following figure.

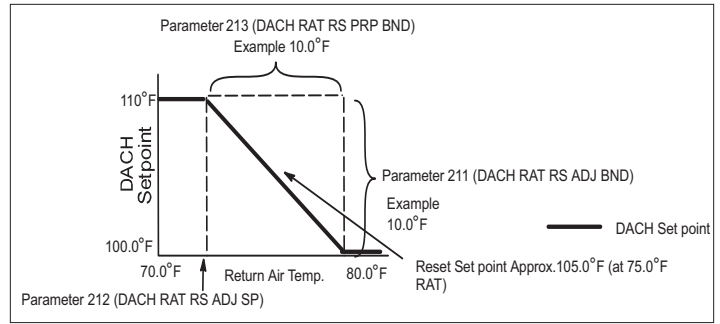


Figure 48. Return Air Reset Example

To use example values, set the following Parameters:

- Parameter 211 – Set to 10.0°F (this setting enables Discharge Air Control Heating Return Air Temperature Adjustment Band)
- Parameter 212 – Set to 70.0°F (this setting enables Discharge Air Control Heating Return Air Reset Set Point)
- Parameter 213 – Set to 10.0°F (this setting enables Discharge Air Control Heating Return Air Temperature Proportional Band)

20.2.3. Discharge Air Control Heating (DACH) Total Reset Limit

Parameter 214 has a default setting of 10°F and defines the total Discharge Air Control Heating setpoint reset limit. This total limit is the sum of both return and outdoor Discharge Air Control Heating resets. This Parameter limits total discharge air control heating adjustment band and overrides the adjustment bands for Return Air Temperature and Outdoor Air Temperature - Parameter 212 and Parameter 208 if necessary.

21. Third-Party Zoning Operations

The M4 unit controller is only compatible with bypass damper actuators specified in the Product Specification bulletin. “Figure 49. Field Wiring Summary for Constant Air Volume Unit with Bypass Damper” is a Constant Air Volume with bypass damper unit wiring summary.

In addition to providing bypass damper control (Constant Air Volume units), the M4 unit controller provides discharge air control for cooling and/or heating. More options are available that control single-stage or two-stage power exhaust fans.

Only four digital inputs are required to control the rooftop unit for third-party zoning applications:

- G (blower enable), thermostat demand
- OCP occupied mode
- Y1 (enables discharge cooling)
- W1 (enables discharge heating)

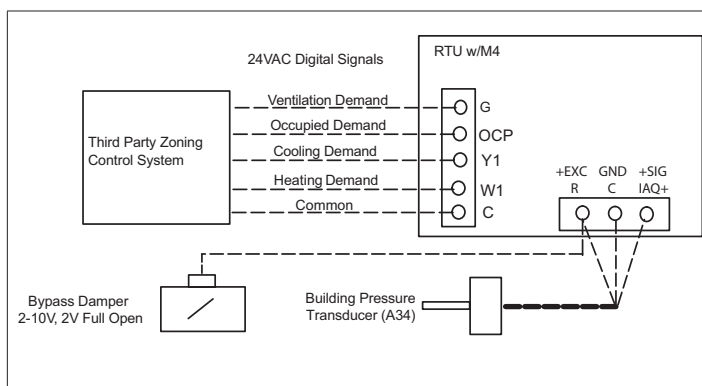


Figure 49. Field Wiring Summary for Constant Air Volume Unit with Bypass Damper

21.1. Air Delivery Operation

When a G signal is energized, the M4 unit controller will control a purchased and field-installed bypass damper to hold a constant supply duct static pressure. The M4 unit controller uses a pressure sensor input and a PID control loop to maintain duct static pressure. For increased flexibility, the M4 unit controller has separate adjustable static pressure setpoints for ventilation, cooling, heating and smoke alarms. Refer to section “18.3. Supply Variable Air Volume (VAV) Control Mode” on page 81 for further details concerning supply air operation.

21.2. Occupied /Unoccupied Operation

When the thermostat demand occupied mode signal is energized, the M4 unit controller will adjust the fresh air damper to a fixed minimum position or a modulating position (based on a carbon dioxide sensor input). Also during morning warm-up/cool-down, the M4 unit controller will keep the damper closed based on the settings selected.

21.3. Cooling Operation

When a Y1 signal is energized the M4 unit controller will control up to four stages of cooling (depending on rooftop unit size) to automatically maintain a constant discharge air cooling temperature.

The M4 unit controller also has advanced discharge air cooling reset options based on return air temperature and/or outside air temperature. Refer to “20.1. Cooling” on page 84 for further details.

21.3.1. Discharge Air Control Cooling Outdoor Air Reset

The outside air reset saves energy by gradually increasing the discharge air setpoint as the outside air temperature decreases.

Refer to “20.1.1. Discharge Air Control Cooling (DACC) Outdoor Air Temperature (OAT) Reset” on page 84 for further details.

21.3.2. Discharge Air Control Cooling Return Air Reset

The return air reset reduces the possibility of over-cooling by gradually increasing the discharge air setpoint as the return air temperature decreases. Over-cooling may occur if the zoning system is misapplied, has an abnormal condition, or a dominant zone. Refer to “20.2.2. Discharge Air Control Heating (DACH) Return Air Temperature Reset” on page 86 for further details.

21.4. Heating Operation

When a W1 signal is energized, the M4 unit controller controls up to four stages of heating (depending on rooftop unit size) to automatically maintain a constant discharge air heating temperature. The M4 unit controller also has advanced discharge air heating reset options based on return air temperature and/or outside air temperature. Refer to “20.2. Heating” on page 85 for further details.

21.4.1. Discharge Air Control Heating Outdoor Air Reset

The outside air reset saves energy by gradually decreasing the discharge air setpoint as the outside air temperature increases. Refer to “20.2.1. Discharge Air Control Heating (DACH) Outdoor Air Temperature Reset” on page 85 for further details.

21.4.2. Discharge Air Control Heating Return Air Reset

The return air reset reduces the possibility of overheating by gradually decreasing the discharge air setpoint as the return air temperature increases. Overheating may occur if the zoning system is miss-applied, has an abnormal condition, or dominant zone. Refer to “20.2.2. Discharge Air Control Heating (DACH) Return Air Temperature Reset” on page 86 for further details.

21.5. Power Exhaust Operation

The M4 unit controller has power exhaust control options that include support for single-stage, two-stage, and variable speed equipment. See Power Exhaust Section.

21.6. Supply Bypass Damper Control

The actuators control the supply air volume for constant air volume units equipped with a bypass damper in zoning applications. The analog control for the actuator is 2-10VDC. Dampers are closed at 10VDC and fully open at 2VDC. This manual uses percent (%) to indicate bypass damper position.

EXAMPLE: Seventy percent bypass damper position is equal to 4.4VDC.

Table 68. Supply Bypass Damper Control

Bypass Damper Position (%)	Control Voltage (VDC)	Bypass Damper Position (%)	Control Voltage (VDC)	Bypass Damper Position (%)	Control Voltage (VDC)	Bypass Damper Position (%)	Control Voltage (VDC)
0 (closed)	10	30	7.6	60	5.2	90	2.8
10	9.2	40	6.8	70	4.4	100	2
20	8.4	50	6	80	3.6		

22. Load Shedding Options

NOTE: This feature is not applicable to all Strategos units.

The M4 unit controller may be setup to de-energize part or all of the mechanical cooling provided by a rooftop unit.

Configuration ID 2, position 8 defines where the digital input for load shedding is configured.

Go to **SETUP > INSTALL > Configuration ID 2, position 8** must be set to one of the following options:

- **N** - NOT INSTALLED
- **G** - GLOBAL INPUT (A55 - P297 - 9)
- **2** - DI-2 (DIGITAL INPUT 2 - A55 - P299 - 4)
- **3** - DI-3 (DIGITAL INPUT 3 - A55 - P299 - 6)

NOTE: When option 2 or 3 are enabled for phase detection on either DI-2 or DI-3, that input cannot be shared with any other devices (i.e., or drain pan overflow). This Parameter 194 defines how many compressors are turned off when load shedding is active (i.e., digital input ON; contact closed).

Table 69. M4 Load Shedding Options

Control Parameter			Control Value			Units	Description
No	Screen Name	Parameter Short Description	Min.	Default	Max.		
194	LOAD SHED NUM COMP	Number of compressors to shed during load shedding.	0	0	4	Option	<p>Number of compressors to be turned off when load shedding is active.</p> <p>For models with two-stage compressors, each stage is treated as a separate compressor for the purpose of load shedding.</p> <p>For example, on an RTU with a single 2-stage compressor, a value of one shuts off 2nd stage only and a value of two turns compressor completely off.</p>

23. Service Relay Operations

The M4 unit controller Service Relay output (A55_P298-8) default operation indicates that service is required.

If the default operation is not required, the Service Relay output may be used as a control output. Use Parameter 186 to choose the input which triggers the Service Relay output. The formula $X + (32 \times Y) + (16 \times Z)$ is used to select the option, where X, Y, and Z are defined as follows:

Table 70. X - Input Source

Value	Behavior	Setpoint	Deadband
0-6	Normal operation	N/A	N/A
7	RH trips relay	Parameter 188	Parameter 191
8	CO ₂ trips relay	Parameter 187	Parameter 190
9	OAT trips relay	Parameter 189	Parameter 192

Table 71. Y - Option

Value	Behavior
0	Hysteresis loop
1	Window
2	Delayed-on
3	Delayed-off

See the following tables for the behavior of these options when Humidity (23.1), IAQ (23.2) or Outdoor Air Temperature (23.3) are selected as the input source.

Table 72. Z - Inverted Logic

Value	Behavior
0	Not inverted
1	Inverted

23.1. System Relative Humidity Options

Table 73. System Relative Humidity Options

Option	Description
0 - Hysteresis	<ul style="list-style-type: none"> ON when relative humidity is equal to or greater than Parameter 188 setting. OFF when relative humidity is less than Parameter 188 setting minus Parameter 191.
1 - Window	<ul style="list-style-type: none"> ON when relative humidity is within range. Parameter 188 plus Parameter 191. <p>NOTE: Fixed 3% relative humidity hysteresis on options 1 - 3</p>
2 - Delayed ON	Only ON when relative humidity is greater than Parameter 188. Otherwise service delay will be OFF.
3 - Delayed OFF	When relative humidity falls below Parameter 188 the service delay is turned OFF once Parameter 193 setting (seconds) is reached.

23.2. System Indoor Air Quality / Carbon Dioxide Options

Table 74. System IAQ / Carbon Dioxide Options

Option	Description
0 - Hysteresis	<ul style="list-style-type: none"> ON when indoor air quality/carbon dioxide is greater than Parameter 187 setting. OFF when indoor air quality/carbon dioxide is less than Parameter 187 minus Parameter 190 setting.
1 - Window	<ul style="list-style-type: none"> ON when indoor air quality/CO₂ within range. Parameter 187 (SRV OUTPT SP CO₂) plus Parameter 190.
2 - Delayed ON	ON when indoor air quality/CO ₂ is greater than Parameter 187. Otherwise service delay will be OFF.
3 - Delayed OFF	When indoor air quality/CO ₂ falls below Parameter 187 the service delay is turned OFF after Parameter 193 setting (seconds) is reached.

23.3. System Outdoor Air Temperature Operation

Table 75. System Outdoor Air Temperature Operation Options

Option	Description
0 - Hysteresis	<ul style="list-style-type: none"> ON when outdoor air temperature is greater Parameter 189 setting. OFF when outdoor air temperature is less than Parameter 189 setting
1 - Window	<ul style="list-style-type: none"> ON when outdoor air temperature is within range. Parameter 189 plus Parameter 192.
2 - Delayed ON	ON when outdoor air temperature is greater than Parameter 189 setting. Otherwise service delay will be OFF.
3 - Delayed OFF	When outdoor air temperature falls below Parameter 189 the service delay is turned off once Parameter 193 setting (seconds) is reached.

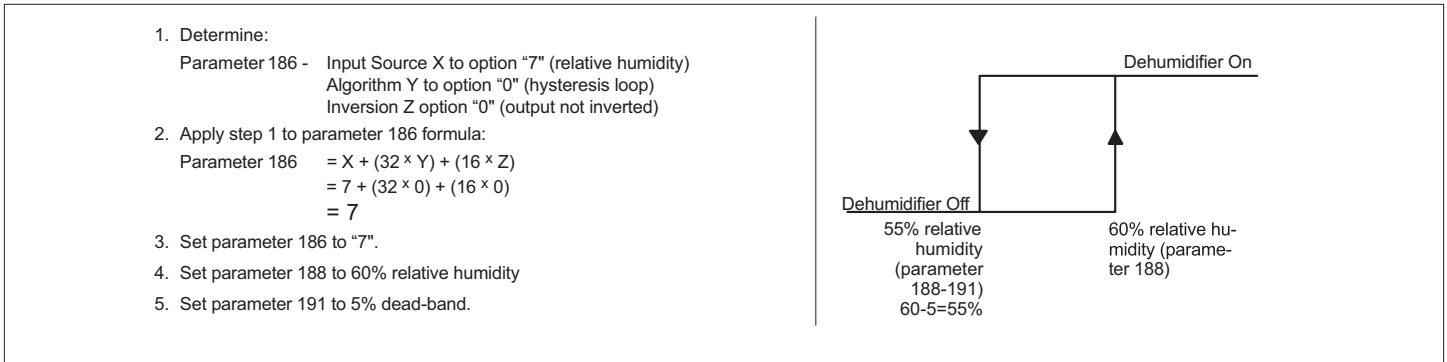


Figure 50. Example 1 — Service Output Energizes Dehumidifier at 60% Relative Humidity / Turns Off at 55% Relative Humidity

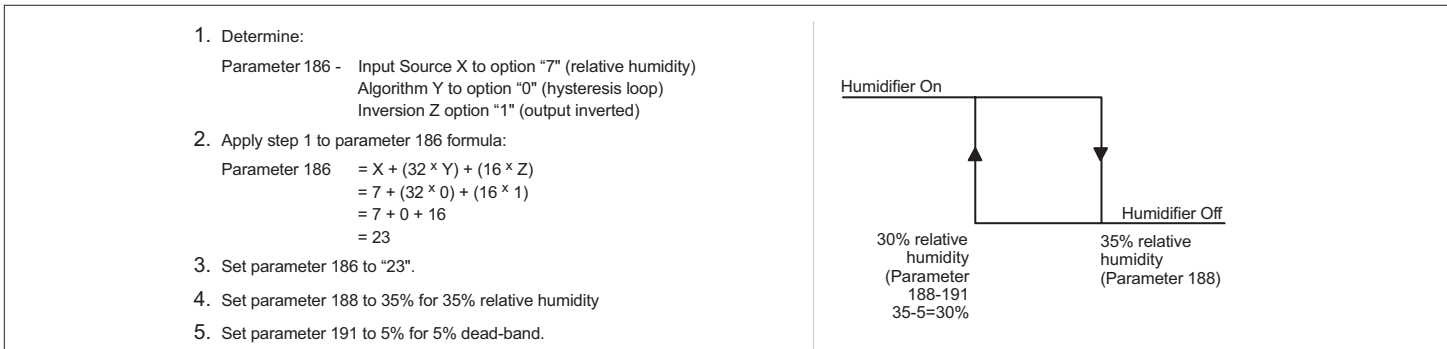
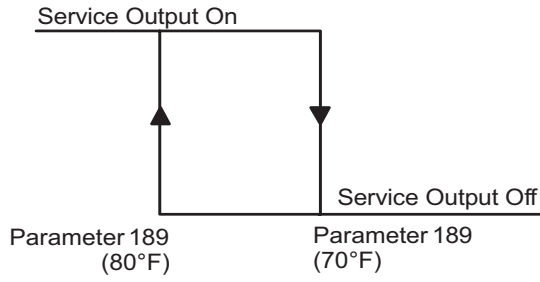
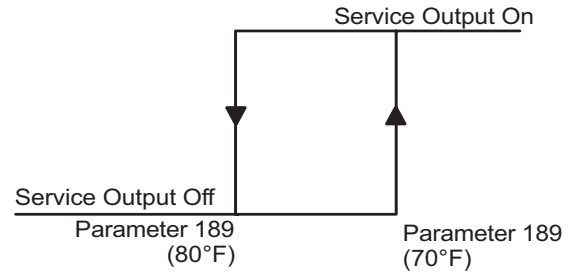


Figure 51. Example 2 — Service Output Energizes Dehumidifier at 30% relative humidity / Turns Off at 35% Relative Humidity



Output Inverted - Input source 9 only



Output NOT Inverted - Input source 9 only

Figure 52. Outdoor Air Temperature Operation - Service Output Energized

NOTE: Use the service output to energize at 80°F and off at 70°F (inverted) and the service output operation being energized at 70°F and off at 80°F (not inverted).

IMPORTANT

This applies to input source option 9 (Outdoor Air Temperature) on Parameter 186.

24. Sequence of Operations

24.1. Unit Controller Control Modes

The M4 Unit controller can operate in several different control modes. The selection of these control modes will depend upon several factors:

- Unit type - Constant Air Volume (CAV) or Multi-Stage Air Volume (MSAV)
- Room application (single-zone, bypass zoning or zoning)
- Which device will control rooftop unit staging and unit operation (thermostat / third-party controller or the M4 unit controller)
- The desired level of unit heating and cooling staging (2 heat / 2 cool or 4 heat / 4 cool)

24.1.1. Unit Controller In Room Sensor Mode

When in the room sensor mode, the M4 unit controller can provide up to four stages of heating and cooling operation. Constant volume units in single-zone applications can use this room sensor mode. The room sensor will provide space temperature information to the M4 unit controller. The M4 unit controller houses all space temperature setpoints and controls all rooftop unit staging and general operation. The M4 unit controller also determines unit error codes, provides diagnostic information and maintains safe operation limits. It is important to note that scheduling and/or setpoint control requires the use of a L Connection Network Control Panel.

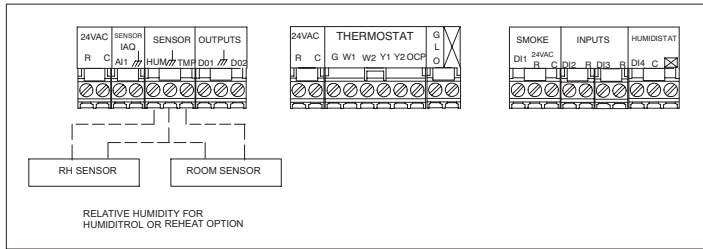


Figure 53. Constant Air Volume Unit in Single-Zone Application

24.1.2. Unit Controller In Thermostat Mode

When in the thermostat mode, the M4 unit controller can provide up to two stages of heating and cooling operation. Three stage cool operation is possible with special setting described in section 2.1.1.

Constant volume units in either single-zone or bypass zoning applications can use this control mode. To operate correctly, a Lennox or third-party thermostat or unit control must provide the following wiring connections to the M4 unit controller:

- Ventilation demand
- Occupied demand
- Heating demand one
- Heating demand two
- Cooling demand one
- Cooling demand two

In this configuration, either the thermostat or unit control will control the rooftop unit staging and general operation. The M4 unit controller functions primarily to determine unit error codes, provide diagnostic information and maintain safe operation limits.

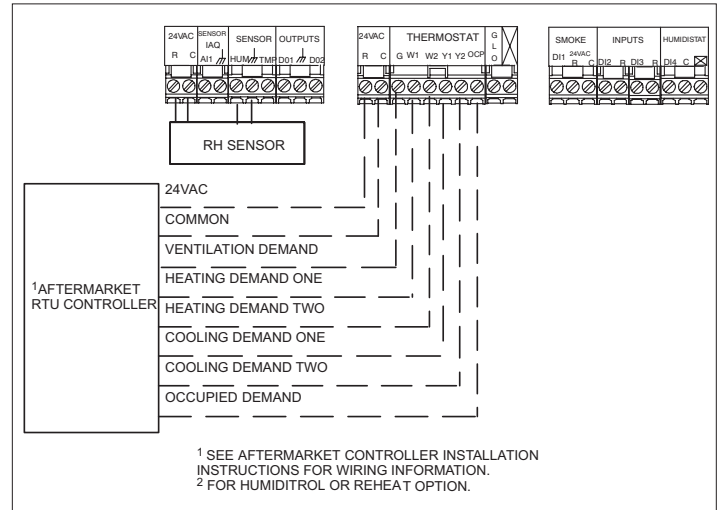


Figure 54. Constant Air Volume Unit in Single-Zone Application

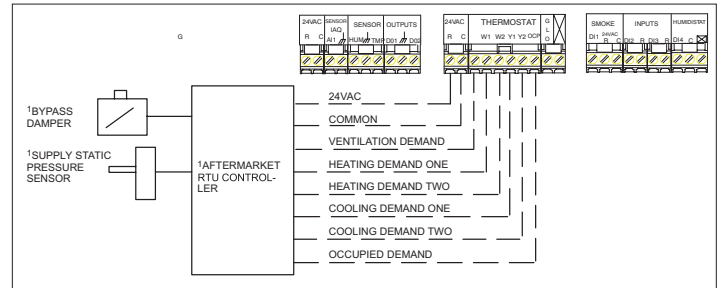


Figure 55. Constant Air Volume Unit in Bypass Zoning Application

When in thermostat mode and configured for discharge air temperature control, the M4 unit controller can provide up to four stages of heating and cooling operation. Variable air volume units using a variable frequency drive on the supply fan and operating in a zoning application must use this control mode. Although not as common, constant volume units in either single-zone or bypass zoning applications may also use this control mode. To operate correctly, a Lennox or third-party thermostat or unit control must provide the following wiring connections to the M4 unit controller:

- Ventilation demand
- Occupied demand
- Heating demand
- Cooling demand

In this control mode the M4 unit controller will control all cooling and heating staging to maintain the discharge air temperature setpoints set in the M4 unit controller (typically 55°F for cooling and 110°F for heating). A third-party unit control, or a thermostat can provide these inputs to the M4 unit controller.

EXAMPLE: If the unit control communicates a demand for cooling then the M4 unit controller activates the refrigeration system and increases or decreases cooling stages to maintain the discharge supply air temperature setpoint. Along with providing control of the rooftop unit, the M4 unit controller also provides error codes and diagnostic information.

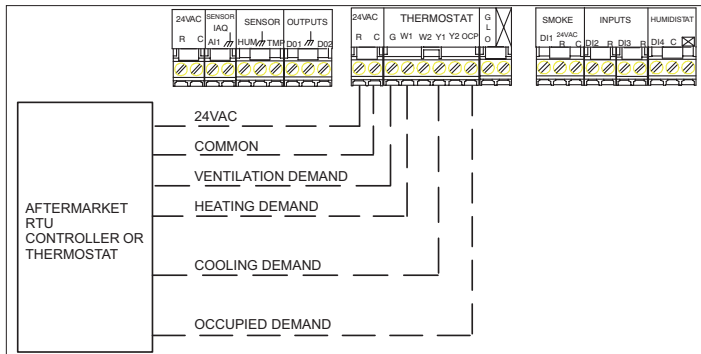


Figure 56. Variable Air Volume Unit in Zoning Application

24.1.3. Operations Common to All Rooftop Units

The following sequence of operation information applies to all rooftop units regardless of M4 unit controller control mode, unit type, or zoning application.

24.1.3.1. Occupied Demand

Upon receiving occupied and ventilation demands from the a zoning control the M4 unit controller adjusts the fresh air damper to either a fixed minimum position or allows it to modulate based on a carbon dioxide sensor (demand control ventilation). The carbon dioxide sensor can be wired directly to the M4 unit controller, to another controller that can monitor the sensor and pass a signal to the M4 unit controller for damper control, or to both the M4 unit controller and another device for monitoring through the desired man-machine interface while the M4 unit controller maintains damper control.

During morning warm-up, the M4 unit controller keeps the fresh air damper closed based on M4 unit controller configuration settings. Setpoints for minimum and maximum damper position and carbon dioxide control reside in the M4 unit controller memory, have factory default settings, and may be adjusted at start up. The user can change these settings either locally or remotely through Lennox L Connection Network® unit controller software (UCS). The user will not have the ability to adjust the settings through third-party software or control devices.

24.1.3.2. Demand Control Ventilation (DCV)

Demand control ventilation is used in applications where the demand for fresh outdoor air fluctuates during the occupied time period. Using a carbon dioxide sensor connected directly to the M4 unit controller, the unit can intelligently increase or decrease the amount of fresh outdoor air by changing the outdoor air damper position. The M4 unit controller has two operation modes available, setpoint or proportional, to control the outdoor air damper position.

24.1.3.3. Fresh Air Tempering (FAT)

In applications with large outdoor air requirements, fresh air tempering is used to minimize temperature fluctuations in the conditioned space. The M4 unit controller controls discharge air temperature by energizing heating or cooling in response to the discharge air temperature. Fresh air tempering only occurs during occupied periods when the blower is running and when there is no heating or cooling demand from the space. The user must configure the M4 unit controller to turn on the fresh air tempering options.

To enable FAH:

Go to RTU MENU > SETUP > TEST & BALANCE > DAMPER

NOTE: There are several settings to select in this path before reaching the desired setting. **FRESH AIR HEATING ENABLE FAH = YES or NO.** After enabling FAH, the next screen allows the FAH setpoint configuration. FAH setpoint range is between 40.0°F to 70.0°F.

To enable FAC:

Go to RTU MENU > SETUP > TEST & BALANCE > DAMPER

NOTE: There are several settings to select in this path before reaching the desired setting. **FRESH AIR COOLING ENABLE FAC = YES or NO.** After enabling FAC, the next screen allows the FAC setpoint configuration. FAC setpoint range is between 60.0°F to 90.0°F.

Heating is energized when discharge air temperature falls below FAH setpoint and terminates when the discharge air temperature rises above the setpoint plus the heating dead-band (FAH default). Cooling is energized when discharge air temperature rises above FAC setpoint and terminates when the discharge air temperature falls below the setpoint minus the cooling dead-band (Parameter 171, 10°F default). Fresh air tempering operates up to four stages of heating and cooling to maintain discharge air temperature. Standard heating and cooling demands overrides FAT heating and cooling demands. When Parameter 113 (EN RET AIR TMP LMT) is enabled, the return air temperature limits set in Parameter 114 (COOL RET AIR LIMIT) and 115 (HEAT RET AIR LIMIT) are enforced on FAT operation as well.

IMPORTANT

For fresh air tempering modes to operate properly, the RT6 discharge sensor must be relocated to the supply air duct.

24.1.3.4. Discharge Air Cooling Reset Operation

Discharge air cooling reset operation saves energy by gradually increasing the discharge air setpoint as outside air temperature decreases. This operation also reduces the potential for over-cooling if the zoning system is misapplied, has an abnormal condition, or has a dominant zone. The M4 unit controller has various advanced discharge air cooling reset options that can be selected at start up and are based on either return air temperature, outside air temperature, or both return and outdoor air temperature.

24.1.3.5. Discharge Air Heating Reset Operation

Discharge air heating reset operation saves energy by gradually decreasing the discharge air setpoint as outside air temperature increases. This operation reduces the potential for overheating if the zoning system is misapplied, has an abnormal condition, or has a dominant zone. The M4

unit controller has various advanced discharge air heating reset options that can be selected at start up and are based on either return air temperature, outside air temperature, or both return and outdoor air temperature.

24.1.3.6. Damper Position Control of Exhaust Fan (Building Pressure)

Enlight, Model L, and Strategos units can control building static pressure with either a standard or high static power exhaust fan. Each fan type is available in either a 50% (one fan) or 100% (two fans) configuration. Standard static power exhaust fans use a propeller while high static power exhaust fans use a centrifugal blower. All units featuring power exhaust fans must also have an economizer.

Control of the fans can occur based on damper position or building differential static pressure transducers located outside the building and in the return duct. Control of power exhaust fans can occur through the M4 unit controller, third-party device or separate M4 unit controller.

24.1.4. CAV Units in Single-Zone Applications with a Lennox Room Sensor

24.1.4.1. Unit Controller Operation (4-Heat / 4-Cool)

When using a Lennox room sensor with the M4 unit controller operating in room sensor mode, a packaged rooftop unit can provide up to four stages each of heating and cooling operation. The room sensor provides space temperature information to the M4 unit controller. The M4 unit controller houses all space temperature setpoints and controls all rooftop unit staging and general operation functions. The M4 unit controller also determines unit error codes, provides diagnostic information, and maintains safe operation limits.

24.1.4.2. Ventilation Demand

When the M4 unit controller is in room sensor control mode, the user has several different ventilation sequence of operation scenarios to choose from. The default mode causes the M4 unit controller to activate the supply fan when both a ventilation and either heating or cooling demand are present. This occurs independent of receiving an occupied demand. The user can change the default setting to allow the supply fan to run continuously when the M4 unit controller receives both a ventilation and occupied demand. This is independent of a call for either heating or cooling. When the M4 unit controller receives a ventilation demand and occupied demand is not present, the M4 unit controller will only activate the supply fan when it receives either a heating or cooling demand.

24.1.4.3. Cooling Demand

The M4 unit controller directly monitors space temperature through the room sensor. Based on this information, the M4 unit controller activates the different compressor stages to maintain the desired occupied space temperature setpoint. Increasing compressor stages provides more cooling capacity while decreasing compressor stages provides less cooling capacity. The M4 unit controller has direct control over the rooftop unit mechanical cooling staging operation. The user has the option to configure the M4 unit controller so that if the room sensor fails, the M4 unit controller can use a

backup operation to control unit operation.

Some rooftop models feature up to four separate compressors and refrigeration circuits that can provide up to four stages of mechanical cooling operation.

24.1.4.4. Cooling Demand with Economizer

If the outdoor air is suitable for free cooling and the unit has an economizer, the M4 unit controller opens the economizer and uses fresh air to provide some cooling. The M4 unit controller may energize additional stages of mechanical cooling as needed if discharge air temperature cannot be maintained with free cooling alone. The M4 unit controller has direct control over the rooftop unit mechanical cooling staging and economizer operation.

24.1.4.5. Heating Demand (General Operation)

The M4 unit controller directly monitors space temperature through the room sensor. Based on this information, the M4 unit controller turns on or off the heating stages to maintain the desired temperature setpoint. Increasing heating stages provides additional heating capacity while decreasing heating stages provides less heating capacity. The M4 unit controller has direct control over rooftop unit heating staging operation. Some units feature four separate heating stages that can provide up to four stages of heating operation. The specific heating capacity varies for each stage depending on the heat source. Depending on the room sensor configuration setting, occupants in the space can change the setpoint. The M4 unit controller automatically recognizes this change and instructs the unit to respond accordingly.

24.1.4.6. Heating Demand (Electric)

Model L, Enlight, Strategos units feature multiple electric heat sections available in sizes from 7.5 kW to 180 kW (depending on unit size and voltage). Units can provide up to four stages of heating depending on the size of the electric heater. Staged operation occurs similar to cooling operation, with the M4 unit controller activating or deactivating sections of the electric heater as the demand for heat increases or decreases.

24.1.4.7. Humiditrol+ Dehumidification Operation - Dehumidification Demand

Upon a dehumidification only demand, the M4 unit controller activates various compressors depending on model for reheating. At the same time, the M4 unit controller will use the solenoid valve(s) to divert hot gas from the compressor(s) to the reheat coil(s).

The cooled and dehumidified air from the evaporator is then reheated as it passes through the reheat coil. The de-superheated and partially condensed refrigerant continues to the outdoor condenser coil where condensing is completed. The reheat coil is sized to offset most of the first and second stages of sensible cooling effect during reheat only operation. This reduction in sensible cooling capacity extends compressor run time to control humidity when cooling loads are light.

The unit continues to operate in this mode until the dehumidification demand is satisfied. A heating or cooling demand terminates reheat operation.

The M4 unit controller relative humidity setpoint is set at the factory for 60% and can be adjusted at the M4 unit controller or with the L Connection Network unit controller software (UCS). For Network Control Panel (Network Control Panel) applications, the humidity setpoint can be adjusted at the Network Control Panel. The M4 unit controller also has an option for an external digital input for the dehumidification demand. This demand must be provided from an external third-party controller.

For unit model specific details, refer to the unit installation instruction.

24.1.4.8. Humiditrol+ Dehumidification Operation - Cooling Demand Only

The unit operates conventionally whenever there is a demand for cooling and no dehumidification demand. The unit can provide up to four stages of mechanical cooling in this scenario. Free cooling is only permitted when an economizer is present, there is no demand for dehumidification, and the outdoor air is suitable for this function.

24.1.4.9. Humiditrol+ Dehumidification Operation - Cooling and Dehumidification Demand

If there is simultaneous cooling and dehumidification demand, Humiditrol+ reheat is not used. For Model L units, enhanced dehumidification, if enabled, is used to provide simultaneous cooling and dehumidification. See “11. Dehumidification Operations” on page 70 for further details.

24.1.5. CAV Units in Single-Zone Applications — Wired Thermostat or Third-Party Unit Controller

24.1.5.1. Unit Controller Operation (2-Heat / 2-Cool)

When using a two-stage heat/ cool thermostat or third-party temperature control with the M4 unit controller in the thermostat mode, a packaged rooftop unit can provide up to two stages of heating and cooling operation. To operate correctly, a thermostat or third-party temperature control must provide the following wiring connections to the M4 unit controller:

- a. Ventilation demand
- b. Occupied demand
- c. Heating demand one
- d. Heating demand two
- e. Cooling demand one
- f. Cooling demand two

In this set up, either the thermostat or third-party temperature control handling the rooftop unit staging and general operation. The M4 unit controller functions primarily to determine unit error codes, provide diagnostic information, and maintain safe operation limits.

24.1.5.2. Ventilation Demand

Upon receiving a ventilation demand from the thermostat or third-party temperature control, the M4 unit controller instructs the supply fan to start operation. The supply fan runs at full capacity as long as a ventilation demand is present.

24.1.5.3. Cooling Demand

(For Model L & Strategos HP) Upon receiving a stage one or stage two demand for cooling, the M4 unit controller operates the indoor blower at either low or high speed.

The controller activates the required number of compressors to maintain discharge air temperature at setpoint.

If configured for three-stage thermostat, the blower operates at low, medium, or high speed.

For Enlight and Strategos GG/EE models, upon receiving a stage one demand for cooling from the thermostat or third-party temperature control, the M4 unit controller activates the required number of compressors to provide a minimum level of cooling capacity. If the unit is unable to satisfy the call for cooling within a specified time period and receives a stage two (or three) cooling demand from the thermostat or third-party temperature control, the M4 unit controller activates additional compressors in order to increase the cooling capacity. The thermostat or third-party controller has direct control over the rooftop unit's staging capability. Refer to section 12 for details.

NOTE: For unit model specific details, refer to the unit installation instruction.

24.1.5.4. Cooling Demand With Economizer

If the unit features an economizer and outdoor air is suitable for free cooling, a call for stage one cooling will activate the economizer. The unit will try to satisfy the cooling demand using outdoor air rather than mechanical cooling.

If the unit is unable to satisfy the call for cooling within a specified time period using the economizer and receives a stage two call for cooling from the thermostat or third-party temperature control, the M4 unit controller will activate another compressor or compressors (model dependent). This will provide 100% cooling capacity. It is important to note that the thermostat or third-party temperature control has direct control over the rooftop unit's staging capability. While the M4 unit controller typically has direct control over the economizer, it is possible for a thermostat or third-party temperature control to directly control this functionality.

NOTE: For unit model specific details, refer to the unit installation instruction.

24.1.5.5. Heating Demand (General Operation)

Upon receiving a stage one heating demand from the thermostat or third-party temperature control, the M4 unit controller activates the unit's heating section to start operation. This activates the first two stages of gas heat if applicable, providing approximately 66% heating capacity.

If the unit is unable to satisfy the call for heating within a specified time period and receives and can support stage two heating demand from the thermostat or third-party controller, the M4 unit controller activates the third and fourth stages of heat if available, providing 100% heating capacity. It is important to note that the thermostat or third-party controller has direct control over the rooftop unit's staging capability.

NOTE: For unit model specific details, refer to the unit installation instruction.

24.1.5.6. Heating Demand (Electric)

Units feature multiple electric heat sections available in sizes 7.5 kW to 180 kW (depending on unit size and voltage). Units can provide up to two stages of electric heating depending on the size of the electric heater. Staged operation occurs similar to cooling operation, with the thermostat or third-party controller activating or deactivating sections of the electric heater as the demand for heat increases or decreases.

24.1.5.7. Humiditrol+ Dehumidification Operation - Dehumidification Demand

Upon a dehumidification demand, the M4 unit controller activates compressor number one (compressor two if applicable). At the same time, the M4 unit controller activates solenoid valves to divert hot gas from compressor one (and compressor 2 if applicable) to the reheat coil. The cooled and dehumidified air from the evaporator is then reheated as it passes through the reheat coil. The de-superheated and partially condensed refrigerant continues to the outdoor condenser coil where condensing is completed. The reheat coil is sized to offset most of the first and second stages (if applicable) of sensible cooling effect during reheat only operation. This reduction in sensible cooling capacity extends compressor run time to control humidity when cooling loads are light.

The unit will continue to operate in this mode until the dehumidification demand is satisfied. A heating demand will terminate reheat operation.

The M4 unit controller relative humidity setpoint is factory configured for 60% and can be adjusted at the M4 unit controller or with the L Connection Network unit controller software (UCS). For Network Control Panel (Network Control Panel) applications, the humidity setpoint can be adjusted at the Network Control Panel. The M4 unit controller also has an option for an external digital input to signal the dehumidification demand. This demand must be provided from an external third-party DDC.

NOTE: For unit model specific details, refer to the unit installation instruction.

24.1.5.8. Humiditrol+ Dehumidification Operation - Cooling Demand Only

The unit operates conventionally whenever there is a demand for cooling and no dehumidification demand. The unit can provide up to two stages of mechanical cooling in this scenario. Free cooling is only permitted when an economizer is present, there is no demand for dehumidification and outdoor air is suitable for this function.

24.1.5.9. Humiditrol+ Dehumidification Operation - Cooling and Dehumidification Demand

If there is simultaneous cooling and dehumidification demand, Humiditrol+ reheat is not used. For Model L units, enhanced dehumidification, if enabled, is used to provide simultaneous cooling and dehumidification. See “11. Dehumidification Operations” on page 70 for further details.

24.1.6. Discharge Air Control (4-Heat / 4-Cool)

24.1.6.1. Unit Controller Operation

When using a thermostat or third-party controller with the M4 unit controller operating in the thermostat mode configured for discharge air temperature control, a packaged rooftop unit can provide up to four stages of heating and cooling operation.

To operate correctly, a thermostat or third-party controller must provide the following wiring connections to the M4 unit controller:

- Ventilation demand
- Occupied demand
- Heating demand
- Cooling demand

In this configuration the M4 unit controller will control the rooftop staging and general operation. The thermostat or third-party controller only informs the M4 unit controller if there is a specific demand.

EXAMPLE: If the thermostat or third-party controller communicates a demand for cooling, the controller increases or decreases cooling stages to maintain the discharge supply air temperature setpoint. Along with providing control of the rooftop unit, the M4 unit controller also provides error codes, diagnostic information, and maintains safe operating limits.

24.1.6.2. Ventilation Demand

Upon receiving a ventilation demand from the thermostat or M4 unit controller, the M4 unit controller activates the supply fan. The supply fan operates at 100% capacity until the ventilation demand has been removed.

24.1.6.3. Cooling Demand

Upon receiving a cooling demand from the thermostat or M4 unit controller, the M4 unit controller instructs the unit to maintain a cooling discharge air temperature setpoint. The M4 unit controller has direct control over the rooftop unit staging. The discharge supply air temperature setpoint resides in the M4 unit controller, has a factory default setting, and can be adjusted at start-up. The user can adjust the setpoint either locally or remotely with Lennox L Connection Network unit controller software (UCS) or at the M4 unit controller. The user can not adjust the setpoint through a third-party control device or software program.

The M4 unit controller receives discharge supply air temperature information directly from the temperature sensor, located in the supply duct system. Based on this information, the M4 unit controller activates the different compressor stages to maintain the discharge supply air temperature setpoint (55°F default). Increasing compressor stages provides more cooling capacity while decreasing compressor stages provides less cooling capacity.

Model L, Enlight, and Strategos units feature up to four separate compressors and refrigeration circuits that can provide up to four stages of mechanical cooling operation.

24.1.6.4. Cooling Demand With Economizer

If outdoor air is suitable for free cooling and the unit has an economizer, the M4 unit controller opens the economizer and uses fresh air for cooling. Cooling stages may be energized as needed to maintain discharge air temperature.

The M4 unit controller has direct control over the rooftop unit staging and economizer operation.

24.1.6.5. Heating Demand (General Operation)

Upon receiving a heating demand from a thermostat or a third-party controller, the M4 unit controller instructs the unit to maintain a heating discharge air temperature setpoint.

The M4 unit controller has direct control over the rooftop unit heating staging operation.

The M4 unit controller receives discharge supply air temperature information directly from the temperature sensor located in the supply duct. Based on this information, the M4 unit controller activates the different heating stages to maintain the discharge supply air temperature setpoint (110°F default).

Turning on additional heating stages increases the heating capacity, while turning off heating stages decreases the heating capacity. The heating discharge air temperature setpoint resides in the M4 unit controller, has a factory default setting, and may be adjusted at start up. The user can adjust the setpoint either locally or remotely with Lennox L Connection Network unit controller software (UCS) or at the M4 unit controller. The user can not adjust the setpoint through a third-party control device or software program.

24.1.6.6. Heating Operation (Electric)

Units feature multiple electric heat sections available in sizes 7.5 kW to 180 kW (depending on unit size and voltage). Units can provide up to four stages of heating depending on the size of the electric heater. Staged operation occurs similar to cooling operation, with the M4 unit controller activating or deactivating sections of the electric heater to maintain the discharge air temperature setpoint.

24.1.7. Bypass Zoning Applications (2-Heat / 2-Cool)

24.1.7.1. Unit Controller Operation

When using a third-party M4 unit controller and the M4 unit controller is operating in the thermostat mode, a packaged rooftop unit can provide up to two stages of heating and cooling operation.

To operate correctly, a M4 unit controller must provide the following wiring connections to the M4 unit controller:

- a. Ventilation demand
- b. Occupied demand
- c. Heating demand one
- d. Heating demand two
- e. Cooling demand one
- f. Cooling demand two

In this configuration the third-party controller will control the rooftop unit staging and general operation. The M4 unit controller functions primarily to determine unit error codes, provide diagnostic information, and maintain safe operating limits.

24.1.7.2. Unit Sequence Of Operation

Constant air volume units in bypass zoning applications featuring a Lennox or third-party controller with the M4 unit controller operating in thermostat mode, have the same basic heating and cooling unit sequence of operations as constant air volume units in single-zone applications featuring a third-party controller, with the M4 unit controller operating in thermostat mode. For specific information, refer to “24.1.5. CAV Units in Single-Zone Applications — Wired Thermostat or Third-Party Unit Controller” on page 95.

The following sequence of operation information is specific to constant air volume units in bypass zoning applications.

24.1.7.3. Supply Duct Bypass Damper

To maintain accurate supply duct static pressure control, constant volume units in bypass zoning applications use a bypass damper between the supply and return air ducts. In this scenario, the supply duct static pressure transducer and damper connect directly to the M4 unit controller. Based on actual static pressure relative to setpoint, the M4 unit controller either modulates open or closes the damper.

If the damper is closed, the static pressure in the supply air duct increases. If the damper modulates further open, the static pressure in the supply air duct decreases.

24.1.8. Bypass Zoning Applications (4-Heat / 4-Cool)

24.1.8.1. Unit Controller Operation

When using a third-party controller and the M4 unit controller is operating in thermostat mode and configured for discharge air temperature control, a packaged rooftop unit can provide up to four stages of heating and cooling operation. To operate correctly, a third-party controller must provide the following wiring connections to the M4 unit controller:

- Ventilation demand
- Occupied demand
- Heating demand
- Cooling demand

In this configuration, the M4 unit controller controls the rooftop staging and general operation. The third-party controller only informs the M4 unit controller as to whether or not there is a specific demand.

EXAMPLE: *If the third-party controller communicates a demand for cooling, then the M4 unit controller increases or decreases cooling stages to maintain the discharge supply air temperature setpoint. Along with controlling the rooftop unit, the M4 unit controller also determines error codes, provides diagnostic information, and maintains safe operating limits.*

24.1.8.2. Unit Sequence of Operation

Constant air volume units in bypass zoning applications featuring a third-party controller with the M4 unit controller operating in thermostat mode, configured for discharge air temperature control have the same basic heating and cooling unit sequence of operations as constant air volume units in single-zone applications featuring a third-party controller, with the M4 unit controller operating in thermostat mode with discharge air temperature control.

For specific unit sequence of operation information refer “24.1.5. CAV Units in Single-Zone Applications — Wired Thermostat or Third-Party Unit Controller” on page 95 and “20. Discharge Air Control Operations” on page 84.

The following sequence of operation information is specific to constant air volume units in bypass zoning applications.

24.1.8.3. Supply Duct Bypass Damper

To maintain accurate supply duct static pressure control, constant volume units in bypass zoning applications typically feature a bypass damper between the supply and return air ducts. In this scenario, the supply duct static pressure transducer and damper connect directly to the M4 unit controller. Based on actual static pressure relative to setpoint, the M4 unit controller either modulates open or modulates closed the bypass damper.

If the damper modulates further closed, the static pressure in the supply air duct increases. If the damper modulates further open, the static pressure in the supply air duct decreases.

25. Unit Operations Summary

25.1.1. Unit Operations - Model L

25.1.1.1. Selecting Minimum Low and Minimum High Damper Positions

The damper will now modulate with blower speed in room sensor mode and not choose 1 of the 2 damper positions. See the following section on damper behavior.

25.1.1.2. Compressor and Humiditrol+ Operation (Model L)

25.1.1.2.1. Behavior Summary - TSTAT

TSTAT Type	Activity	Compressors				Reheat Valves		Blower*	Outdoor Fan (normal ambient conditions)	Damper
		C1 (variable speed)	C2	C3	C4	1	2			
2-Stage	Normal Cooling	Modulates to DAT Setpoint (Parameter 375)	Stage up/down based on DAT			OFF		Y1: Low Cool Speed Y2: High Cool Speed	Speed varies with amount of mechanical cooling	Modulates with blower CFM (OCP) or Closed (UNOCP)
	Enhanced Dehumidification**	Modulates to EDH DAT Setpoint (Parameter 376)								
	Free Cooling	Y1: OFF Y2: Modulates to DAT = 55°F (Parameter 159)	Y1: OFF Y2: Stage up/down based on DAT		Y1: Low Cool Speed (but if damper full open for 5 min, High Cool Speed) Y2: High Cool Speed			Y1: Modulates to DAT = 55°F (Parameter 159) Y2: Max		
	Fresh Air Cooling	Modulates to FC DAT Setpoint (Parameter 170)	Stage up/down based on DAT							Ventilation speed
	Humiditrol+ Reheat**	Modulates to RH Setpoint (analog RH sensor) OR 100% (DI4)	Stage up/down as needed	OFF				ON w/C1		ON w/C2
3-Stage	Normal Cooling	Modulates to DAT Setpoint (Parameter 375)	Stage up/down based on DAT			OFF		Y1: Low Cool Speed Y2: Med Cool Speed Y3: High Cool Speed	Speed varies with amount of mechanical cooling	Modulates with blower CFM (OCP) or Closed (UNOCP)
	Enhanced Dehumidification	Modulates to EDH DAT Setpoint (Parameter 376)								
	Free Cooling	Y1: OFF Y2/Y3: Modulates to DAT = 55°F (Parameter 159)	Y1: OFF Y2/Y3: Stage up/down based on DAT		Y1: Low Cool Speed (but if damper full open for 5 min, Med Cool Speed) Y2: Med Cool Speed Y3: High Cool Speed			Y1: Modulates to DAT = 55°F (Parameter 159) Y2/Y3: Max		
	Fresh Air Cooling	Modulates to FC DAT Setpoint (Parameter 170)	Stage up/down based on DAT							Ventilation speed
	Humiditrol+ Reheat	Modulates to RH Setpoint (analog RH sensor) OR 100% (DI4)	Stage up/down as needed	OFF				ON w/C1		ON w/C2

* For DACC/VAV operation, blower modulates to maintain duct static pressure.

** Enhanced Dehumidification and Humiditrol+ Reheat not supported in DACC/VAV operation.

25.1.1.3. Behavior Summary - Room Sensor

Activity	Compressors				Reheat Valves		Blower*	Outdoor Fan (normal ambient conditions)	Damper
	C1 (variable speed)	C2	C3	C4	1	2			
Normal Cooling	Modulates to DAT Setpoint (Parameter 375)	Stage up/down based on DAT			OFF		Modulates to zone temperature setpoint	Speed varies with amount of mechanical cooling	Modulates with blower CFM (OCP) or Closed (UNOCP)
Enhanced Dehumidification**	Modulates to EDH DAT Setpoint (calculated)								
Free Cooling	OFF or Modulates to DAT = 55°F (Parameter 159)								
Fresh Air Cooling	Modulates to FC DAT Setpoint (Parameter 170)						Ventilation speed		Follows ventilation rules
Humiditrol+ Reheat**	Modulates to RH Setpoint (analog RH sensor) OR 100% (DI4)	Stage up/down as needed	OFF		ON w/C1	ON w/C2	Modulates to calculated SST setpoint	Modulates to calculated DAT setpoint	Modulates with blower CFM (OCP) or Closed (UNOCP)
* For DACC/VAV operation, blower modulates to maintain duct static pressure.									
** Enhanced Dehumidification and Humiditrol+ Reheat not supported in DACC/VAV operation.									

25.1.1.4. Behavior Summary - Heating/Ventilation

Activity	Compressors				Reheat Valves		Blower	Outdoor Fan (normal ambient conditions)	Damper
	C1 (variable speed)	C2	C3	C4	1	2			
Heating (W)	OFF						Heating Speed	OFF	Minimum
Ventilation (G)	OFF						Ventilation speed	OFF	Closed (UNOCP) or Minimum (OCP)

25.1.2. Unit Operations - Strategos HP

25.1.2.1. Selecting Minimum Low and Minimum High Damper Positions

The damper will now modulate with blower speed in room sensor mode and not choose 1 of the 2 damper positions. See the following section on damper behavior.

25.1.2.2. Compressor Operation (Strategos HP)

25.1.2.2.1. Behavior Summary - Strategos HP, TSTAT Cooling

TSTAT Type	Activity	Compressors*		Reversing Valves		Blower	Outdoor Fan (normal ambient conditions)	Damper
		C1 (variable speed)	C2 (variable speed)	1	2			
2-Stage	Normal Cooling	Modulates to DAT Setpoint (Parameter 375)	stage up/down if needed to maintain DAT runs at same speed as C1	ON when C1 is running	ON when C2 is running	Y1: Low Cool Speed Y2: High Cool Speed	Speed varies with amount of mechanical cooling	Modulates with blower CFM (OCP) or Closed (UNOCP)
	Enhanced Dehumidification**	Modulates to EDH DAT Setpoint (Parameter 376)						
	Free Cooling	Y1: OFF Y2: Modulates to DAT = 55°F (Parameter 159)				Y1: Low Cool Speed (but if damper full open for 5 min, High Cool Speed) Y2: High Cool Speed		Y1: Modulates to DAT = 55°F (Parameter 159) Y2: Max
	Fresh Air Cooling	Modulates to FC DAT Setpoint (Parameter 170)						Follows ventilation rules
3-Stage	Normal Cooling	Modulates to DAT Setpoint (Parameter 375)	stage up/down if needed to maintain DAT runs at same speed as C1	ON when C1 is running	ON when C2 is running	Y1: Low Cool Speed Y2: Med Cool Speed Y3: High Cool Speed	Speed varies with amount of mechanical cooling	Modulates with blower CFM (OCP) or Closed (UNOCP)
	Enhanced Dehumidification	Modulates to EDH DAT Setpoint (Parameter 376)						
	Free Cooling	Y1: OFF Y2/Y3: Modulates to DAT = 55°F (Parameter 159)				Y1: Low Cool Speed (but if damper full open for 5 min, Med Cool Speed) Y2: Med Cool Speed Y3: High Cool Speed		Y1: Modulates to DAT = 55°F (Parameter 159) Y2/Y3: Max
	Fresh Air Cooling	Modulates to FC DAT Setpoint (Parameter 170)						Follows ventilation rules

* Variable speed compressors modulate to maintain DAT after a 2 minute controlled startup period.

25.1.2.3. Behavior Summary - Strategos HP Room Sensor Cooling

Activity	Compressors		Reversing Valves		Blower*	Outdoor Fan (normal ambient conditions)	Damper
	C1 (variable speed)	C2 (variable speed)	1	2			
Normal Cooling	Modulates to DAT Setpoint (Parameter 375)	stage up/down if needed to maintain DAT runs at same speed as C1	ON when C1 is running	ON when C2 is running	Modulates to zone temperature setpoint	Speed varies with amount of mechanical cooling	Modulates with blower CFM (OCP) or Closed (UNOCP)
Enhanced Dehumidification**	Modulates to EDH DAT Setpoint (calculated)						
Free Cooling	OFF or Modulates to DAT = 55°F (Parameter 159)						
Fresh Air Cooling	Modulates to FC DAT Setpoint (Parameter 170)				Ventilation speed		Follows ventilation rules

* Variable speed compressors modulate to maintain DAT after a 2 minute controlled startup period.

25.1.2.4. Behavior Summary - Strategos HP Ventilation

Activity	Compressors		Reversing Valves		Blower	Outdoor Fan (normal ambient conditions)	Damper
	C1 (variable speed)	C2 (variable speed)	1	2			
Ventilation (G)	OFF		OFF	OFF	Ventilation speed	OFF	Closed (UNOCP) or Minimum (OCP)

25.1.2.5. Behavior Summary - Strategos HP TSTAT Heating

TSTAT Type	Activity	Compressors*		Reversing Valves		Blower	Outdoor Fan (normal ambient conditions)	Damper	Aux. Heat
		C1 (variable speed)	C2 (variable speed)	1	2				
2-Stage	Mechanical Heating Only	Modulates to DAT Setpoint (Parameter 629)	Stage up/down if needed to maintain DAT, runs at same speed as C1	OFF	OFF	W1: Low Heat Speed W2: High Heat Speed	Speed varies with amount of mechanical heating	Minimum	OFF
	Mechanical + Electric Heating					W1: High Heat Speed W2: High Heat Speed			W1: OFF W2: HI
	Electric Heating Only	OFF	OFF			W1: High Heat Speed W2: High Heat Speed	OFF		W1: LO (2-stage EH) or W1: HI (1-stage EH) W2: HI
	Gas Heating Only					W1: High Heat Speed W2: High Heat Speed	OFF		W1: LO W2: HI

TSTAT Type	Activity	Compressors*		Reversing Valves		Blower	Outdoor Fan (normal ambient conditions)	Damper	Aux. Heat
		C1 (variable speed)	C2 (variable speed)	1	2				
3-Stage	Mechanical Heating Only	Modulates to DAT Setpoint (Parameter 629)	Stage up/down if needed to maintain DAT, runs at same speed as C1	OFF	OFF	W1: Low Heat Speed W2: High Heat Speed W3: High Heat Speed	Speed varies with amount of mechanical heating	Minimum	OFF
	Mechanical + Electric Heating					W1: Low Heat Speed W2: High Heat Speed W3: High Heat Speed			W1: OFF W2: LO (2-stage EH) or W2: HI (1-stage EH) W3: HI
	Electric Heating Only	OFF	OFF			W1: High Heat Speed W2: High Heat Speed W3: High Heat Speed	OFF		W1: LO W2: HI W3: HI
	Gas Heating Only	OFF	OFF			W1: High Heat Speed W2: High Heat Speed W3: High Heat Speed	OFF		
Either	Defrost C1	ON at defrost speed	ON at defrost speed	ON	OFF	Defrost Speed	C1 fans OFF, others vary with C2 heating	Minimum	HI if 1-compressor unit else
	Defrost C2	ON at defrost speed	ON at defrost speed	OFF	ON	Defrost Speed	C2 fans OFF, others vary with C1 heating		EH per W stage, GH OFF

* Variable speed compressors modulate to maintain DAT after a 2-minute controlled startup period.

25.1.2.6. Behavior Summary - Strategos HP Room Sensor Heating

Activity	Compressors*		Reversing Valves		Blower	Outdoor Fan (normal ambient conditions)	Damper	Aux. Heat (demand: 1/2/4 aux stages)	
	C1 (variable speed)	C2 (variable speed)	1	2					
Mechanical Heating Only	Modulates to DAT Setpoint (Parameter 629)	Stage up/down if needed to maintain DAT, runs at same speed as C1	OFF	OFF	Modulates to zone temperature setpoint	Speed varies with amount of mechanical heating	Minimum	OFF	
Mechanical + Electric Heating								H1: OFF/OFF/OFF H2: 100/50/25% H3: 100/100/50% H4: 100/100/100%	
Electric Heating Only	OFF	OFF				OFF		OFF	H1: 100/50/25% H2: 100/100/50% H3: 100/100/75% H4: 100/100/100%
Gas Heating Only									
Defrost C1	ON at defrost speed	ON at defrost speed	ON	OFF	Defrost Speed	C1 fans OFF, others vary with C2 heating	100% if 1-compressor unit else EH per H stage, GH OFF		
Defrost C2			OFF	ON		C2 fans OFF, others vary with C1 heating			

* Variable speed compressors modulate to maintain DAT after a 2-minute controlled startup period.

Activity		Compressors*		Reversing Valves		Blower	Outdoor Fan (normal ambient conditions)	Damper	Aux. Heat (demand: 1/2/4 aux stages)
		C1 (variable speed)	C2 (variable speed)	1	2				
3-Stage	Mechanical Heating Only	Modulates to DAT Setpoint (Parameter 629)	Stage up/down if needed to maintain DAT, runs at same speed as C1	OFF	OFF	W1: Low Heat Speed	Speed varies with amount of mechanical heating	Minimum	OFF
	Mechanical + Electric Heating					W2: High Heat Speed			W1: OFF
	Electric Heating Only	OFF	OFF			W2: LO (2-stage EH) or W2: HI (1-stage EH)			
	Gas Heating Only	OFF	OFF			W3: HI			
Either	Defrost C1	ON at defrost speed	ON at defrost speed	ON	OFF	Defrost Speed	C1 fans OFF, others vary with C2 heating	Minimum	HI if 1-compressor unit else EH per W stage, GH OFF
	Defrost C2	ON at defrost speed	ON at defrost speed	OFF	ON	Defrost Speed	C2 fans OFF, others vary with C1 heating		

* Variable speed compressors modulate to maintain DAT after a 2 minute controlled startup period.

25.1.3. Unit Operations - Enlight/Strategos

25.1.3.1. Select Minimum Low and Minimum High Damper Positions-Enlight

The following tables reference minimum damper positions which have two possible values for units with MSAV blower option, Parameter 9 = MIN DAMPER LOW BLWR or Parameter 132 = MIN DAMPER POSITION. Which minimum damper position is used depends on a mid-point calculation and actual blower speed.

The mid-point speed is determined as (Min Cool CFM + Max Cool CFM)/2 from those available for the number of compressors installed. Then if actual blower speed is < mid-point Parameter 9 is used, otherwise Parameter 132 used. For units with VAV blower, there is only one minimum damper position (Parameter 132).

25.1.3.2. Behavior Summary - Enlight/Strategos A-Box, 1 Compressor, 2-stage TSTAT

Operation Mode	Demands			Condition	Unit Operation							
	TSTAT	Humidity Sensor	Trigger	OAS	Compressor		Blower Speeds			FA Damper (Economizer)	Reheat Valve 1	
					1-PL	1-FL	Vent	Cool				Heat
								C1	C2			
Blower	G		UNOCP		OFF	OFF	X				Closed	OFF
	G		OCP		OFF	OFF	X				Minimum	OFF
Free Cooling	Y1			Suit	OFF	OFF		X			Modulate up to Max	OFF
	Y2			Suit	OFF	OFF			X		Modulate up to Max	OFF
	Y2		damper position @ max pos & time	Suit	ON	OFF			X		Max	OFF
Normal Cooling	Y1			Not Suit	ON	OFF		X			Minimum	OFF
	Y2			Not Suit	ON	ON			X		Minimum	OFF
Dehumidification		Dehum			ON	ON		X			Minimum	ON
	Y1	Dehum			ON	ON		X			Minimum	OFF
	Y2	Dehum			ON	ON			X		Minimum	OFF
Heating	W				OFF	OFF				X	Minimum	OFF

25.1.3.3. Behavior Summary - Enlight/Strategos A Box, 1 Compressor, 3-stage TSTAT or Zone Sensor

Operation Mode	Demands				Condition	Unit Operation							
	TSTAT w/o DACC	Zone Sensor or TSTAT + DACC	Humidity Sensor	Trigger		OAS	Compressor		Blower Speeds			FA Damper (Economizer)	Reheat Valve 1
							1-PL	1-FL	Vent	Cool			
		C1	C2										
Blower	G	Vent		UNOCP		OFF	OFF	X				Closed	OFF
	G	Vent		OCP		OFF	OFF	X				Min_low	OFF
Free Cooling	Y1	Cstg1			Suit	OFF	OFF		X			Modulate up to Max	OFF
	Y2	Cstg2			Suit	OFF	OFF			X		Modulate up to Max	OFF
	Y2	NA		damper position @ max pos & time	Suit	ON	OFF				X	Max	OFF
	Y3	Cstg2		damper position @ max pos & time	Suit	ON	ON				X	Max	OFF
Normal Cooling	Y1	Cstg1			Not Suit	ON	OFF		X			Minimum	OFF
	Y2	Cstg2			Not Suit	ON	ON			X		Minimum	OFF
	Y3	Cstg3			Not Suit	ON	ON			X		Minimum	OFF
Dehumidification			Dehum			ON	ON		X			Minimum	ON
	Y1	Cstg1	Dehum			ON	ON		X			Minimum	OFF
	Y2	Cstg2	Dehum			ON	ON			X		Minimum	OFF
	Y3	Cstg3	Dehum			ON	ON			X		Minimum	OFF
Heating	W	Hstg1				OFF	OFF				X	Minimum	OFF

25.1.3.4. Behavior Summary - Enlight/Strategos B Box, 2 Compressor, 2-stage TSTAT

Operation Mode	Demands			Condition	Unit Operation									
	TSTAT	Humidity Sensor	Trigger		OAS	Compressor			Blower Speeds				FA Damper (Economizer)	Reheat Valve 1
						1-PL	1-FL	2	Vent	Cool				
		C1	C2	C3										
Blower	G		UNOCP		OFF	OFF	OFF	X					Closed	OFF
	G		OCP		OFF	OFF	OFF	X					Minimum	OFF
Free Cooling	Y1			Suit	OFF	OFF	OFF		X				Modulate up to Max	OFF
	Y2			Suit	OFF	OFF	OFF				X		Modulate up to Max	OFF
	Y2		damper position @ max pos & time	Suit	ON	ON	OFF					X	Max	OFF
Normal Cooling	Y1			Not Suit	ON	ON	OFF		X				Minimum	OFF
	Y2			Not Suit	ON	ON	ON				X		Minimum	OFF
Dehumidification		Dehum			ON	ON	OFF		X				Minimum	ON
	Y1	Dehum			ON	ON	ON				X		Minimum	ON
	Y2	Dehum			ON	ON	ON				X		Minimum	OFF
Heating	W				OFF	OFF	OFF					X	Minimum	OFF

25.1.3.5. Behavior Summary - Enlight/Strategos B Box, 2 Compressors 3-stage TSTAT or Zone Sensor

Operation Mode	Demands				Condition	Unit Operation									
	TSTAT w/o DACC	Zone Sensor or TSTAT + DACC	Humidity Sensor	Trigger		OAS	Compressor				Blower Speeds				FA Damper (Economizer)
					1-PL		1-FL	2	Vent	Cool			Heat		
										C1	C2	C3			
Blower	G	Vent		UNOCP		OFF	OFF	OFF	X					Closed	OFF
	G	Vent		OCP		OFF	OFF	OFF	X					Min_low	OFF
Free Cooling	Y1	Cstg1			Suit	OFF	OFF	OFF			X			Modulate up to Max	OFF
	Y2	Cstg2			Suit	OFF	OFF	OFF				X		Modulate up to Max	OFF
	Y2	Cstg2		damper position @ max pos & time	Suit	ON	OFF	OFF				X		Max	OFF
	Y3	NA			Suit	ON	ON	OFF				X		Max	OFF
Normal Cooling	NA	Cstg3			Suit	ON	ON	ON				X		Max	OFF
	Y1	Cstg1			Not Suit	ON	OFF	OFF		X				Minimum	OFF
	Y2	Cstg2			Not Suit	ON	OFF	ON			X			Minimum	OFF
Dehumidification	Y3	Cstg3			Not Suit	ON	ON	ON				X		Minimum	OFF
			Dehum			ON	ON	OFF		X				Minimum	ON
	Y1	Cstg1	Dehum			ON	ON	ON			X			Minimum	ON
	Y2	Cstg2	Dehum			ON	ON	ON				X		Minimum	ON
	Y3	Cstg3	Dehum			ON	ON	ON				X		Minimum	OFF
Heating	W	Hstg1				OFF	OFF	OFF					X	Minimum	OFF

25.1.3.6. Behavior Summary - Enlight C1-Box, 2 Compressors, 2-stage TSTAT

Operation Mode	Demands			Condition	Unit Operation											
	TSTAT	Humidity Sensor	Trigger		OAS	Compressor				Blower Speeds				FA Damper (Economizer)	Reheat Valve 1	Reheat Valve 2
				1-PL		1-FL	2	Vent	Cool			Heat				
									C1	C2	C3					
Blower	G		UNOCP		OFF	OFF	OFF	X						Closed	OFF	OFF
	G		OCP		OFF	OFF	OFF	X						Minimum	OFF	OFF
Free Cooling	Y1			Suit	OFF	OFF	OFF		X					Modulate up to Max	OFF	OFF
	Y2			Suit	OFF	OFF	OFF				X			Modulate up to Max	OFF	OFF
	Y2		damper position @ max pos & time	Suit	ON	ON	OFF				X			Max	OFF	OFF
Normal Cooling	Y1			Not Suit	ON	ON	OFF		X					Minimum	OFF	OFF
	Y2			Not Suit	ON	ON	ON				X			Minimum	OFF	OFF
Dehumidification		Dehum			ON	ON	ON		X					Minimum	ON	ON
	Y1	Dehum			ON	ON	ON				X			Minimum	ON	OFF
	Y2	Dehum			ON	ON	ON				X			Minimum	OFF	OFF
Heating	W				OFF	OFF	OFF					X		Minimum	OFF	OFF

25.1.3.7. Behavior Summary - Enlight C1 - Box, 2 Compressors 3-stage TSTAT or Zone Sensor

Operation Mode	Demands			Condition	Unit Operation											
	TSTAT w/o DACC	Zone Sensor or TSTAT + DACC	Humidity Sensor		Trigger	OAS	Compressor			Blower Speeds			FA Damper (Economizer)	Reheat Valve 1	Reheat Valve 2	
	OR						1-PL	1-FL	2	Vent	Cool					Heat
										C1	C2	C3				
Blower	G	Vent		UNOCP		OFF	OFF	OFF	X					Closed	OFF	OFF
	G	Vent		OCP		OFF	OFF	OFF	X					Min_low	OFF	OFF
Free Cooling	Y1	Cstg1			Suit	OFF	OFF	OFF			X			Modulate up to Max	OFF	OFF
	Y2	Cstg2			Suit	OFF	OFF	OFF				X		Modulate up to Max	OFF	OFF
	Y2	Cstg2		damper position @ max pos & time	Suit	ON	OFF	OFF				X		Max	OFF	OFF
	Y3	NA			Suit	ON	ON	OFF				X		Max	OFF	OFF
Normal Cooling	NA	Cstg3			Suit	ON	ON	ON				X		Max	OFF	OFF
	Y1	Cstg1			Not Suit	ON	OFF	OFF		X				Minimum	OFF	OFF
	Y2	Cstg2			Not Suit	ON	OFF	ON			X			Minimum	OFF	OFF
Dehumidification	Y3	Cstg3			Not Suit	ON	ON	ON				X		Minimum	OFF	OFF
			Dehum			ON	ON	ON		X				Minimum	ON	ON
	Y1	Cstg1	Dehum			ON	ON	ON		X				Minimum	ON	OFF
	Y2	Cstg2	Dehum			ON	ON	ON				X		Minimum	ON	OFF
	Y3	Cstg3	Dehum			ON	ON	ON				X		Minimum	OFF	OFF
Heating	W	Hstg1				OFF	OFF	OFF					X	Minimum	OFF	OFF

25.1.3.8. Behavior Summary - Enlight C2 - Box, 3 Compressors, 2-stage TSTAT

Operation Mode	Demands			Condition	Unit Operation													
	TSTAT	Humidity Sensor	Trigger		OAS	Compressor			Blower Speeds				FA Damper (Economizer)	Reheat Valve 1	Reheat Valve 2			
						1	2	3	Vent	Cool						Heat		
											C1	C2	C3	C4				
Blower	G		UNOCP		OFF	OFF	OFF	X								Closed	OFF	OFF
	G		OCP		OFF	OFF	OFF	X								Min	OFF	OFF
Free Cooling	Y1			Suit	OFF	OFF	OFF			X						Modulate up to Max	OFF	OFF
	Y2			Suit	OFF	OFF	OFF				X					Modulate up to Max	OFF	OFF
	Y2		damper position @ max pos & time	Suit	ON	ON	OFF					X				Max	OFF	OFF
Normal Cooling	Y1			Not Suit	ON	ON	OFF				X					Min	OFF	OFF
	Y2			Not Suit	ON	ON	ON					X				Min	OFF	OFF
Dehumidification		Dehum			ON	ON	OFF				X					Min	ON	ON
	Y1	Dehum			ON	ON	ON					X				Min	ON	ON
	Y2	Dehum			ON	ON	ON					X				Min	OFF	OFF
Heating	W				OFF	OFF	OFF							X	Min	OFF	OFF	

25.1.3.9. Behavior Summary - Enlight C2-Box, 3 Compressors, 3-stage TSTAT

Operation Mode	Demands			Condition	Unit Operation											
	TSTAT w/o DACC	Humidity Sensor	Trigger		OAS	Compressor			Blower Speeds				FA Damper (Economizer)	Reheat Valve 1	Reheat Valve 2	
				1		2	3	Vent	Cool							Heat
									C1	C2	C3	C4				
Blower	G		UNOCP		OFF	OFF	OFF	X						Closed	OFF	OFF
	G		OCP		OFF	OFF	OFF	X						Min	OFF	OFF
Free Cooling	Y1			Suit	OFF	OFF	OFF			X				Modulate up to Max	OFF	OFF
	Y2			Suit	OFF	OFF	OFF				X			Modulate up to Max	OFF	OFF
	Y2		damper position @ max pos & time	Suit	ON	OFF	OFF				X			Max open	OFF	OFF
	Y3			Suit	ON	ON	OFF				X			Max open	OFF	OFF
	NA			Suit	ON	ON	ON				X			Max open	OFF	OFF
Normal Cooling	Y1			Not Suit	ON	OFF	OFF		X					Min	OFF	OFF
	Y2			Not Suit	ON	ON	OFF			X				Min	OFF	OFF
	Y3			Not Suit	ON	ON	ON				X			Min	OFF	OFF
Dehumidification		Dehum			ON	ON	OFF		X					Min	ON	ON
	Y1	Dehum			ON	ON	ON				X			Min	ON	ON
	Y2	Dehum			ON	ON	ON				X			Min	ON	OFF
	Y3	Dehum			ON	ON	ON				X			Min	OFF	OFF
Heating	W				OFF	OFF	OFF					X	Min	OFF	OFF	

25.1.3.10. Behavior Summary - Enlight C2-Box, 3 Compressors, Zone Sensor or DACC

Operation Mode	Demands			Condition	Unit Operation											
	Zone Sensor or TSTAT + DACC	Humidity Sensor	Trigger		OAS	Compressor			Blower Speeds				FA Damper (Economizer)	Reheat Valve 1	Reheat Valve 2	
						1	2	3	Vent	Cool						Heat
									C1	C2	C3	C4				
Blower	Vent		UNOCP		OFF	OFF	OFF	X						Closed	OFF	OFF
	Vent		OCF		OFF	OFF	OFF	X						Min	OFF	OFF
Free Cooling	Cstg1			Suit	OFF	OFF	OFF			X				Modulate up to Max	OFF	OFF
	Cstg2			Suit	OFF	OFF	OFF				X			Modulate up to Max	OFF	OFF
	Cstg2		damper position @ max pos & time	Suit	ON	OFF	OFF				X			Max	OFF	OFF
	Cstg3			Suit	ON	ON	ON				X			Max	OFF	OFF
	Cstg4			Suit	ON	ON	ON				X			Max	OFF	OFF
Normal Cooling	Cstg1			Not Suit	ON	OFF	OFF		X					Min	OFF	OFF
	Cstg2			Not Suit	ON	ON	OFF			X				Min	OFF	OFF
	Cstg3			Not Suit	ON	ON	ON				X			Min	OFF	OFF
	Cstg4			Not Suit	ON	ON	ON				X			Min	OFF	OFF
Dehumidification		Dehum			ON	ON	OFF		X					Min	ON	ON
	Cstg1	Dehum			ON	ON	ON				X			Min	ON	ON
	Cstg2	Dehum			ON	ON	ON				X			Min	ON	OFF
	Cstg3	Dehum			ON	ON	ON				X			Min	OFF	OFF
	Cstg4	Dehum			ON	ON	ON				X			Min	OFF	OFF
Heating	Hstg1				OFF	OFF	OFF					X	Min	OFF	OFF	

25.1.3.11. Behavior Summary - Enlight C2-Box, 4 Compressors, 4 Outdoor Fans, 2-Stage TSTAT

Operation Mode	Demands			Condition	Unit Operation												
	TSTAT	Humidity Sensor	Trigger	OAS	Compressor				Blower Speeds					FA Damper (Economizer)	Reheat Valve 1	Reheat Valve 2	
					1	2	3	4	Vent	Cool							Heat
										C1	C2	C3	C4				
Blower	G		UNOCP		OFF	OFF	OFF	OFF	X						Closed	OFF	OFF
	G		OCP		OFF	OFF	OFF	OFF	X						Min	OFF	OFF
Free Cooling	Y1		damper position	Suit	OFF	OFF	OFF	OFF			X				Modulate up to Max	OFF	OFF
	Y2		damper position	Suit	OFF	OFF	OFF	OFF					X		Modulate up to Max	OFF	OFF
	Y2		damper position @ max pos & time	Suit	ON	ON	OFF	OFF					X		Max	OFF	OFF
Normal Cooling	Y1			Not Suit	ON	ON	OFF	OFF			X				Min	OFF	OFF
	Y2			Not Suit	ON	ON	ON	ON					X		Min	OFF	OFF
Dehumidification		Dehum			ON	ON	OFF	OFF			X				Min	ON	ON
	Y1	Dehum			ON	ON	ON	ON					X		Min	ON	ON
	Y2	Dehum			ON	ON	ON	ON					X		Min	OFF	OFF
Heating	W				OFF	OFF	OFF	OFF						X	Min	OFF	OFF

25.1.3.12. Behavior Summary - Enlight C2-Box, 4 Compressors, 4 Outdoor Fans, 3-Stage TSTAT

Operation Mode	Demands			Condition	Unit Operation												
	TSTAT w/o DACC	Humidity Sensor	Trigger	OAS	Compressor				Blower Speeds					FA Damper (Economizer)	Reheat Valve 1	Reheat Valve 2	
					1	2	3	4	Vent	Cool							Heat
										C1	C2	C3	C4				
Blower	G		UNOCP		OFF	OFF	OFF	OFF	X						Closed	OFF	OFF
	G		OCP		OFF	OFF	OFF	OFF	X						Min	OFF	OFF
Free Cooling	Y1			Suit	OFF	OFF	OFF	OFF				X			Modulate up to Max	OFF	OFF
	Y2			Suit	OFF	OFF	OFF	OFF					X		Modulate up to Max	OFF	OFF
	Y2		damper position @ max pos & time	Suit	ON	ON	OFF	OFF					X		Max	OFF	OFF
	Y3			Suit	ON	ON	ON	OFF					X		Max	OFF	OFF
Normal Cooling	Y1			Not Suit	ON	ON	OFF	OFF			X				Min	OFF	OFF
	Y2			Not Suit	ON	ON	ON	OFF				X			Min	OFF	OFF
	Y3			Not Suit	ON	ON	ON	ON					X		Min	OFF	OFF
Dehumidification		Dehum			ON	ON	OFF	OFF			X				Min	ON	ON
	Y1	Dehum			ON	ON	ON	ON					X		Min	ON	ON
	Y2	Dehum			ON	ON	ON	ON					X		Min	ON	OFF
	Y3	Dehum			ON	ON	ON	ON					X		Min	OFF	OFF
Heating	W				OFF	OFF	OFF	OFF						X	Min	OFF	OFF

25.1.3.13. Behavior Summary - Enlight C2-Box, 4 Compressors, 4 Outdoor Fans, Zone Sensor or DACC

Operation Mode	Demands			Condition	Unit Operation												
	Zone Sensor or TSTAT + DACC	Humidity Sensor	Trigger	OAS	Compressor				Blower Speeds				FA Damper (Economizer)	Reheat Valve 1	Reheat Valve 2		
					1	2	3	4	Vent	Cool						Heat	
										C1	C2	C3					C4
Blower	Vent		UNOCP		OFF	OFF	OFF	OFF	X						Closed	OFF	OFF
	Vent		OCP		OFF	OFF	OFF	OFF	X						Min	OFF	OFF
Free Cooling	Cstg1			Suit	OFF	OFF	OFF	OFF				X			Modulate up to Max	OFF	OFF
	Cstg2			Suit	OFF	OFF	OFF	OFF					X		Modulate up to Max	OFF	OFF
	Cstg2		damper position @ max pos & time	Suit	ON	OFF	OFF	OFF					X		Max	OFF	OFF
	Cstg3			Suit	ON	ON	OFF	OFF						X	Max	OFF	OFF
	Cstg4			Suit	ON	ON	ON	ON						X	Max	OFF	OFF
Normal Cooling	Cstg1			Not Suit	ON	OFF	OFF	OFF		X					Min	OFF	OFF
	Cstg2			Not Suit	ON	ON	OFF	OFF			X				Min	OFF	OFF
	Cstg3			Not Suit	ON	ON	ON	OFF				X			Min	OFF	OFF
	Cstg4			Not Suit	ON	ON	ON	ON					X		Min	OFF	OFF
Dehumidification		Dehum			ON	ON	OFF	OFF		X					Min	ON	ON
	Cstg1	Dehum			ON	ON	ON	OFF					X		Min	ON	ON
	Cstg2	Dehum			ON	ON	ON	ON					X		Min	ON	ON
	Cstg3	Dehum			ON	ON	ON	ON					X		Min	ON	OFF
	Cstg4	Dehum			ON	ON	ON	ON					X		Min	OFF	OFF
Heating	Hstg1				OFF	OFF	OFF	OFF						X	Min	OFF	OFF

25.1.3.14. Behavior Summary - Enlight C3/D-Box, Strategos D-Box 4 Compressors, 6 Outdoor Fans, 2-Stage TSTAT

Operation Mode	Demands			Condition	Unit Operation																				
	TSTAT	Humidity Sensor	Trigger		OAS	Compressor				Blower Speeds					FA Damper (Economizer)	Reheat Valve 1	Reheat Valve 2								
						1	2	3	4	Vent	Cool							Heat							
											C1	C2	C3	C4											
Blower	G		UNOCP		OFF	OFF	OFF	OFF	X							Closed	OFF	OFF							
	G		OCP		OFF	OFF	OFF	OFF	X							Min	OFF	OFF							
Free Cooling	Y1		damper position	Suit	OFF	OFF	OFF	OFF			X				Modulate up to Max	OFF	OFF								
	Y2		damper position	Suit	OFF	OFF	OFF	OFF					X		Modulate up to Max	OFF	OFF								
	Y2		damper position @ max pos & time	Suit	ON	ON	OFF	OFF					X		Max	OFF	OFF								
Normal Cooling	Y1			Not Suit	ON	ON	OFF	OFF			X				Min	OFF	OFF								
	Y2			Not Suit	ON	ON	ON	ON					X		Min	OFF	OFF								
Dehumidification		Dehum			ON	ON	OFF	OFF			X				Min	ON	ON								
	Y1	Dehum			ON	ON	ON	ON					X		Min	ON	ON								
	Y2	Dehum			ON	ON	ON	ON					X		Min	OFF	OFF								
Heating	W				OFF	OFF	OFF	OFF						X	Min	OFF	OFF								

25.1.3.15. Behavior Summary - Enlight C3/D-Box, Strategos D-Box 4 Compressors, 6 Outdoor Fans, 3-Stage TSTAT

Operation Mode	Demands			Condition	Unit Operation																				
	TSTAT	Humidity Sensor	Trigger		OAS	Compressor				Blower Speeds					FA Damper (Economizer)	Reheat Valve 1	Reheat Valve 2								
						1	2	3	4	Vent	Cool							Heat							
											C1	C2	C3	C4											
Blower	G		UNOCP		OFF	OFF	OFF	OFF	X							Closed	OFF	OFF							
	G		OCP		OFF	OFF	OFF	OFF	X							Min	OFF	OFF							
Free Cooling	Y1			Suit	OFF	OFF	OFF	OFF				X			Modulate up to Max	OFF	OFF								
	Y2			Suit	OFF	OFF	OFF	OFF					X		Modulate up to Max	OFF	OFF								
	Y2		damper position @ max pos & time	Suit	ON	ON	OFF	OFF					X		Max	OFF	OFF								
	Y3			Suit	ON	ON	ON	OFF					X		Max	OFF	OFF								
Normal Cooling	Y1			Not Suit	ON	ON	OFF	OFF			X				Min	OFF	OFF								
	Y2			Not Suit	ON	ON	ON	OFF				X			Min	OFF	OFF								
	Y3			Not Suit	ON	ON	ON	ON					X		Min	OFF	OFF								

Operation Mode	Demands			Condition	Unit Operation												
	TSTAT	Humidity Sensor	Trigger	OAS	Compressor				Blower Speeds					FA Damper (Economizer)	Reheat Valve 1	Reheat Valve 2	
					1	2	3	4	Vent	Cool							Heat
Dehumidification		Dehum			ON	ON	OFF	OFF			X				Min	ON	ON
	Y1	Dehum			ON	ON	ON	ON					X		Min	ON	ON
	Y2	Dehum			ON	ON	ON	ON					X		Min	ON	OFF
	Y3	Dehum			ON	ON	ON	ON					X		Min	OFF	OFF
Heating	W				OFF	OFF	OFF	OFF						X	Min	OFF	OFF

25.1.3.16. Behavior Summary - Enlight C3/D-Box, Strategos D-Box 4 Compressors, 6 OD Fans, Zone Sensor or DACC

Operation Mode	Demands			Condition	Unit Operation												
	Zone Sensor or TSTAT + DACC	Humidity Sensor	Trigger	OAS	Compressor				Blower Speeds					FA Damper (Economizer)	Reheat Valve 1	Reheat Valve 2	
					1	2	3	4	Vent	Cool							Heat
Blower	Vent		UNOCP		OFF	OFF	OFF	OFF	X						Closed	OFF	OFF
	Vent		OCP		OFF	OFF	OFF	OFF	X						Min	OFF	OFF
Free Cooling	Cstg1			Suit	OFF	OFF	OFF	OFF				X			Modulate up to Max	OFF	OFF
	Cstg2			Suit	OFF	OFF	OFF	OFF					X		Modulate up to Max	OFF	OFF
	Cstg2		damper position @ max pos & time	Suit	ON	OFF	OFF	OFF						X	Max	OFF	OFF
	Cstg3			Suit	ON	ON	OFF	OFF						X	Max	OFF	OFF
	Cstg4			Suit	ON	ON	ON	ON						X	Max	OFF	OFF
Normal Cooling	Cstg1			Not Suit	ON	OFF	OFF	OFF		X					Min	OFF	OFF
	Cstg2			Not Suit	ON	ON	OFF	OFF			X				Min	OFF	OFF
	Cstg3			Not Suit	ON	ON	ON	OFF				X			Min	OFF	OFF
	Cstg4			Not Suit	ON	ON	ON	ON					X		Min	OFF	OFF
Dehumidification		Dehum			ON	ON	OFF	OFF		X					Min	ON	ON
	Cstg1	Dehum			ON	ON	ON	OFF					X		Min	ON	ON
	Cstg2	Dehum			ON	ON	ON	ON					X		Min	ON	ON
	Cstg3	Dehum			ON	ON	ON	ON					X		Min	ON	OFF
	Cstg4	Dehum			ON	ON	ON	ON					X		Min	OFF	OFF
Heating	Hstg1				OFF	OFF	OFF	OFF						X	Min	OFF	OFF

25.1.3.17. Behavior Summary - Enlight Heat Pump A-Box, 1 Compressor, 2-Stage TSTAT

Operation Mode	Demands			Condition	Unit Operation										
	TSTAT	Coil Sensor	Trigger		OAS	Compressor		Blower Speeds					FA Damper (Economizer)	Reversing Valve 1	Supp. Heat
				1-PL		1-FL	Vent	Cool		Heat	Gas				
								C1	C2		LO	HI			
Blower	G		UNOCP		OFF	OFF	X						Closed	OFF	OFF
	G		OCP		OFF	OFF	X						Minimum	OFF	OFF
Free Cooling	Y1			Suit	OFF	OFF		X					Modulate up to Max	OFF	OFF
	Y2			Suit	OFF	OFF			X				Modulate up to Max	OFF	OFF
	Y2		damper position @ max pos & time	Suit	ON	OFF			X				Max	ON	OFF
Normal Cooling	Y1			Not Suit	ON	OFF		X					Minimum	ON	OFF
	Y2			Not Suit	ON	ON			X				Minimum	ON	OFF
Heating + No Aux. Heat	W1				ON	ON				X			Minimum	OFF	OFF
	W2				ON	ON				X			Minimum	OFF	OFF
Heating + Elec. Heat	W1				ON	ON				X			Minimum	OFF	OFF
	W2				ON	ON				X			Minimum	OFF	HI
Heating + Gas Heat (2-Stage)	W1			>Bal Point	ON	ON				X			Minimum	OFF	OFF
				<Bal Point	OFF	OFF				X		Minimum	OFF	LO	
	W2				OFF	OFF					X		Minimum	OFF	HI
Heating + Gas Heat (Single Stage)	W1			>Bal Point	ON	ON							Minimum	OFF	OFF
				<Bal Point	OFF	OFF					X		Minimum	OFF	HI
	W2				OFF	OFF					X		Minimum	OFF	HI
Defrost	Comp 1	SLT< Δ T SP	@ Defrost Gas	*	ON	ON						X	Minimum	ON	HI
			@ Defrost Elec/ no Aux Heat		ON	ON								Minimum	ON

25.1.3.18. Behavior Summary - Enlight Heat Pump A-Box, 1 Compressor, 3-Stage TSTAT or Zone Sensor

Operation Mode	Demands				Condition	Unit Operation									
	TSTAT w/o DACC	Zone Sensor or TSTAT + DACC	Coil Sensor	Trigger	OAS	Compressor		Blower Speeds					FA Damper (Economizer)	Reversing Valve 1	Supp. Heat
	OR					1-PL	1-FL	Vent	Cool		Heat	Gas			
			C1	C2	LO				HI						
Blower	G	Vent		UNOCP		OFF	OFF	X					Closed	OFF	OFF
	G	Vent		OCP		OFF	OFF	X					Min_low	OFF	OFF
Free Cooling	Y1	Cstg1			Suit	OFF	OFF		X				Modulate up to Max	OFF	OFF
	Y2	Cstg2			Suit	OFF	OFF			X			Modulate up to Max	OFF	OFF
	Y2	NA		damper position @ max pos & time	Suit	ON	OFF			X			Max	ON	OFF
	Y3	Cstg2		damper position @ max pos & time	Suit	ON	ON			X			Max	ON	OFF
Normal Cooling	Y1	Cstg1			Not Suit	ON	OFF		X				Minimum	ON	OFF
	Y2	Cstg2			Not Suit	ON	ON			X			Minimum	ON	OFF
	Y3	Cstg3			Not Suit	ON	ON			X			Minimum	ON	OFF
Heating + No Aux. Heat	W1	Hstg1				ON	ON				X		Minimum	OFF	OFF
	W2	Hstg2				ON	ON				X		Minimum	OFF	OFF
	W3	Hstg3				ON	ON				X		Minimum	OFF	OFF
Heating + Elec. Heat	W1	Hstg1				ON	ON				X		Minimum	OFF	OFF
	W2	Hstg2				ON	ON				X		Minimum	OFF	HI
	W3	Hstg3				ON	ON				X		Minimum	OFF	HI*
Heating + Gas Heat (2-Stage)	W1	Hstg1			>Bal Point	ON	ON				X		Minimum	OFF	OFF
					<Bal Point	OFF	OFF					X	Minimum	OFF	LO
	W2	Hstg2			>Bal Point	OFF	OFF				X		Minimum	OFF	LO
	W2	Hstg2			<Bal Point	OFF	OFF					X	Minimum	OFF	HI
	W3	Hstg3				OFF	OFF					X	Minimum	OFF	HI
Heating + Gas Heat (Single Stage)	W1	Hstg1			>Bal Point	ON	ON				X		Minimum	OFF	OFF
					<Bal Point	OFF	OFF						X	Minimum	OFF
	W2	Hstg2				OFF	OFF					X	Minimum	OFF	HI
	W3	Hstg3				OFF	OFF					X	Minimum	OFF	HI
Defrost	Comp 1		LST< Δ T SP	@ Defrost Gas	*	ON	ON					X	Minimum	ON	HI
				@ Defrost Elec/ no Aux Heat		ON	ON							Minimum	ON

* For units with 1 Stage of Electric Heating, only W1 and W2 will be available for Zone Sensor.

25.1.3.19. Behavior Summary - Enlight Heat Pump B-Box/B2/B3, 2 Compressors, 2-Stage TSTAT

Operation Mode	Demands			Condition	Unit Operation														
	TSTAT	Coil Sensor	Trigger		OAS	Compressor			Blower Speeds						FA Damper (Economizer)	Reversing Valve 1	Reversing Valve 1	Supp. Heat	
						1-PL	1-FL	2	Vent	Cool			Heat	Gas					
										C1	C2	C3		LO	HI				
Blower	G		UNOCP			OFF	OFF	OFF	X							Closed	OFF	OFF	OFF
	G		OCF			OFF	OFF	OFF	X							Minimum	OFF	OFF	OFF
Free Cooling	Y1			Suit		OFF	OFF	OFF		X						Modulate up to Max	OFF	OFF	OFF
	Y2			Suit		OFF	OFF	OFF			X					Modulate up to Max	OFF	OFF	OFF
Normal Cooling	Y1			Not Suit		ON	ON	OFF		X						Minimum	ON	OFF	OFF
	Y2			Not Suit		ON	ON	ON			X					Minimum	ON	ON	OFF
Heating + No Heat	W1					ON	ON	ON					X			Minimum	OFF	OFF	-
	W2					ON	ON	ON					X			Minimum	OFF	OFF	-
Heating + Elec. Heat	W1					ON	ON	ON					X			Minimum	OFF	OFF	OFF
	W2					ON	ON	ON					X			Minimum	OFF	OFF	HI
Heating + Gas Heat	W1			>Bal Point		ON	ON	ON					X			Minimum	OFF	OFF	OFF
	W2			<Bal Point		OFF	OFF	OFF						X		Minimum	OFF	OFF	LO
Defrost* Gas Heat	Compressor 1	LST 1 <ΔT SP		DC		ON	ON	ON					X			Minimum	ON	OFF	OFF
	Compressor 2	LST 2 <ΔT SP	@ Defrost Cycle	DC		ON	ON	ON								Minimum	OFF	ON	OFF
Defrost* Elec. Heating	Compressor 1	LST 1 <ΔT SP		DC		ON	ON	ON					X			Minimum	ON	OFF	ON
	Compressor 2	LST 2 <ΔT SP		DC		ON	ON	ON								Minimum	OFF	ON	ON

* Compressor 1 goes into Defrost, Compressor 2 will remain in Heating; if Compressor 2 goes into Defrost, Compressor 1 shall remain in Heating.

25.1.3.20. Behavior Summary - Enlight Heat Pump B-Box/B2/B3, 2 Compressors, 3-Stage TSTAT or Zone Sensor

Operation Mode	Demands			Condition	Unit Operation													
	TSTAT w/o DACC	Zone Sensor or TSTAT + DACC	Coil Sensor		Trigger	OAS	Compressor			Blower Speeds			FA Damper (Economizer)	Reversing Valve 1	Reversing Valve 1	Supp. Heat		
							1-PL	1-FL	2	Vent	Cool	Heat					Gas	
		OR																
Blower	G	Vent		UNOCP														
	G	Vent		OCP														
Free Cooling	Y1	Cstg1			Suit					X								
	Y2	Cstg2			Suit						X							
	Y2	Cstg2		dampers position @ max pos & time	Suit						X							
Normal Cooling	Y3	NA			Suit													
	NA	Cstg3			Suit													
	Y1	Cstg1			Not Suit				X									
	Y2	Cstg2			Not Suit					X								
	Y3	Cstg3			Not Suit						X							
	W1	Hstg1										X						
Heating + No Aux. Heat	W2	Hstg2										X						
	N/A	Hstg3										X						
	W1	Hstg1										X						
Heating + Elec. Heat	W2	Hstg2											X					
	N/A	Hstg3												X				
	W1	Hstg1													X			

* Compressor 1 goes into Defrost, Compressor 2 will remain in Heating; if Compressor 2 goes into Defrost, Compressor 1 shall remain in Heating

** For units with 1 Stage of Electric Heating, only W1 and W2 will be available for Zone Sensor.

Operation Mode	Demands				Condition	Unit Operation												
	TSTAT w/o DACC	Zone Sensor or TSTAT + DACC	Coil Sensor	Trigger		Compressor			Blower Speeds					FA Damper (Economizer)	Reversing Valve 1	Reversing Valve 1	Supp. Heat	
						1-PL	1-FL	2	Vent	Cool			Heat					Gas
										C1	C2	C3	LO	HI				
Heating + Gas Heat	W1	Hstg1			OAS	OFF	OFF	OFF					X		Minimum	OFF	OFF	Low
						OFF	OFF	OFF										
	W2	Hstg2				OFF	OFF	OFF						X	Minimum	OFF	OFF	High
	N/A	Hstg3				OFF	OFF	OFF						X	Minimum	OFF	OFF	High
	W1	Hstg1			" OAT > Bal Point"	ON	ON	ON		X					Minimum	OFF	OFF	OFF
	W2	Hstg2				OFF	OFF	OFF					X		Minimum	OFF	OFF	Low
Defrost* Gas Heat	N/A	Hstg3				OFF	OFF	OFF						X	Minimum	OFF	OFF	High
	Comp 1		LST 1 <ΔT SP	@ Defrost Cycle	DC	ON							X		Minimum	ON	OFF	OFF
	Comp 2		LST 2 <ΔT SP		DC	ON							X		Minimum	OFF	ON	OFF
	Comp 1		LST 1 <ΔT SP		DC	ON							X		Minimum	ON	OFF	ON
Defrost* Elec. Heating	Comp 2		LST 2 <ΔT SP		DC	ON							X		Minimum	OFF	ON	ON

* Compressor 1 goes into Defrost, Compressor 2 will remain in Heating; if Compressor 2 goes into Defrost, Compressor 1 shall remain in Heating

** For units with 1 Stage of Electric Heating, only W1 and W2 will be available for Zone Sensor.

25.1.3.21. Behavior Summary - Enlight Heat Pump C3-Box, 2 Compressors, 2-Stage TSTAT

Operation Mode	Demands			Condition	Unit Operation															
	TSTAT	Coil Sensor	Trigger		OAS	Compressor			Blower Speeds						FA Damper (Economizer)	Reversing Valve 1	Reversing Valve 1	Supp. Heat		
						1-PL	1-FL	2	Vent	Cool			Heat						Gas	
										C1	C2	C3		LO	HI					
Blower	G		UNOCP			OFF	OFF	OFF	X								Closed	OFF	OFF	OFF
	G		OCP			OFF	OFF	OFF	X								Minimum	OFF	OFF	OFF
Free Cooling	Y1			Suit		OFF	OFF	OFF		X							Modulate up to Max	OFF	OFF	OFF
	Y2			Suit		OFF	OFF	OFF			X						Modulate up to Max	OFF	OFF	OFF
	Y2			Suit	damper position @ max pos & time	ON	ON	OFF				X					Max	ON	OFF	OFF
Normal Cooling	Y1			Not Suit		ON	ON	OFF		X							Minimum	ON	OFF	OFF
	Y2			Not Suit		ON	ON	ON			X						Minimum	ON	ON	OFF
Heating + No Heat	W1					ON	ON	ON				X					Minimum	OFF	OFF	-
	W2					ON	ON	ON				X					Minimum	OFF	OFF	-
Heating + Elec. Heat	W1					ON	ON	ON				X					Minimum	OFF	OFF	OFF
	W2					ON	ON	ON				X					Minimum	OFF	OFF	HI
Heating + Gas Heat	W1			>Bal Point		ON	ON	ON				X					Minimum	OFF	OFF	OFF
	W2			<Bal Point		OFF	OFF	OFF					X				Minimum	OFF	OFF	LO
Defrost* Gas Heat	W2					OFF	OFF	OFF									Minimum	OFF	OFF	HI
	Comp 1	LST 1 < Δ T SP		DC	'@ Defrost Cycle	ON							X				Minimum	ON	OFF	OFF
Defrost* Elec. Heating	Comp 2	LST 2 < Δ T SP		DC		ON							X				Minimum	OFF	ON	OFF
	Comp 1	LST 1 < Δ T SP		DC		ON							X				Minimum	ON	OFF	ON
	Comp 2	LST 2 < Δ T SP		DC		ON							X				Minimum	OFF	ON	ON
	Comp 2	LST 2 < Δ T SP		DC		ON							X				Minimum	OFF	ON	ON

*Compressor 1 goes into Defrost, Compressor 2 will remain in Heating; if Compressor 2 goes into Defrost, Compressor 1 will remain in Heating.

25.1.3.22. Behavior Summary - Enlght Heat Pump C3-Box, 2 Compressors, 3-Stage TSTAT or Zone Sensor

Operation Mode	Demands				Condition	Unit Operation													
	TSTAT w/o DACC	Zone Sensor or TSTAT + DACC	Coil Sensor	Trigger		OAS	Compressor			Blower Speeds						FA Damper (Economizer)	Reversing Valve 1	Reversing Valve 1	Supp. Heat
							1-PL	1-FL	2	Vent	Cool	Heat	Gas						
									C1	C2	C3	LO	HI						
Blower	G	Vent		UNOCP				OFF	OFF	OFF	X					Closed	OFF	OFF	
	G	Vent		OCP				OFF	OFF	OFF	X					Min_low	OFF	OFF	
Free Cooling	Y1	Cstg1			Suit			OFF	OFF	OFF		X				Modulate up to Max	OFF	OFF	
	Y2	Cstg2			Suit			OFF	OFF	OFF			X			Modulate up to Max	OFF	OFF	
Normal Cooling	Y2	Cstg2		damper position @ max pos & time	Suit			ON	OFF	OFF		X				Max	ON	OFF	
	Y3	NA			Suit			ON	ON	OFF		X				Max	ON	OFF	
	NA	Cstg3			Suit			ON	ON	ON		X				Max	ON	ON	
	Y1	Cstg1			Not Suit			ON	OFF	OFF	X					Minimum	ON	OFF	
Heating + No Aux. Heat	Y2	Cstg2			Not Suit			ON	OFF	ON		X				Minimum	ON	ON	
	Y3	Cstg3			Not Suit			ON	ON	ON			X			Minimum	ON	ON	
	W1	Hstg1						ON	ON	ON				X		Minimum	OFF	OFF	
Heating + Elec. Heat	W2	Hstg2						ON	ON	ON				X		Minimum	OFF	OFF	
	N/A	Hstg3						ON	ON	ON				X		Minimum	OFF	OFF	
	W1	Hstg1			" OAT < Bal Point"			OFF	OFF	OFF				X		Minimum	OFF	OFF	
Heating + Gas Heat	W2	Hstg2						OFF	OFF	OFF				X		Minimum	OFF	OFF	
	N/A	Hstg3						OFF	OFF	OFF				X		Minimum	OFF	OFF	
	W1	Hstg1			" OAT > Bal Point"			ON	ON	ON				X		Minimum	OFF	OFF	
Heating + Gas Heat	W2	Hstg2						OFF	OFF	OFF				X		Minimum	OFF	OFF	
	N/A	Hstg3						OFF	OFF	OFF				X		Minimum	OFF	OFF	
	W1	Hstg1						ON	ON	ON				X		Minimum	OFF	OFF	

* CMP 1 goes into Defrost, CMP 2 shall remain in Heating, if CMP 2 goes into Defrost, CMP 1 shall remain in Heating

** For Units with 1 Stage of E Heating, only W1 and W2 will be available for Zone Sensor

25.1.3.23. Behavior Summary - Enlight Heat Pump D-Box, 2 Compressors, 2-Stage TSTAT

Operation Mode	Demands			Condition	Unit Operation													
	TSTAT w/o DACC	Coil Sensor	Trigger		OAS	Compressor			Blower Speeds				FA Damper (Economizer)	Reversing Valve 1	Reversing Valve 1	Supp. Heat		
						1-PL	1-FL	2	Vent	C1	C2	C3					C4	Heat
Blower	G		UNOCP		OFF	OFF	OFF	X							Closed	OFF	OFF	OFF
	G		OC		OFF	OFF	OFF	X							Minimum	OFF	OFF	OFF
Free Cooling	Y1			Suit	OFF	OFF	OFF		X						Modulate up to Max	OFF	OFF	OFF
	Y2			Suit	OFF	OFF	OFF			X					Modulate up to Max	OFF	OFF	OFF
Cooling	Y1			Not Suit	ON	OFF	OFF			X					Minimum	ON	OFF	OFF
	Y2			Not Suit	ON	ON	ON				X				Minimum	ON	ON	OFF
Heating + No Heat	W1				ON	ON	ON					X			Minimum	OFF	OFF	-
	W2				ON	ON	ON					X			Minimum	OFF	OFF	-
Heating + E Heating	W1				ON	ON	ON					X			Minimum	OFF	OFF	OFF
	W2				ON	ON	ON					X			Minimum	OFF	OFF	HI
Heating + Gas Heat	W1			>Bal Point	ON	ON	ON					X			Minimum	OFF	OFF	OFF
	W2			<Bal Point	OFF	OFF	OFF						X		Minimum	OFF	OFF	LO
Defrost** Gas Heat	CMP 1	LST 1 <ΔT SP		DC	OFF	OFF	OFF								Minimum	OFF	OFF	HI
	CMP 2	LST 2 <ΔT SP	@ Defrost Cycle	DC	ON	ON	ON				X				Minimum	ON	OFF	OFF
Defrost** E Heating	CMP 1	LST 1 <ΔT SP		DC	ON	ON	ON					X			Minimum	ON	OFF	ON
	CMP 2	LST 2 <ΔT SP		DC	ON	ON	ON						X		Minimum	OFF	ON	ON

** CMP 1 goes into Defrost, CMP 2 shall remain in Heating, if CMP 2 goes into Defrost, CMP 1 shall remain in Heating

25.1.3.24. Behavior Summary - Enlight Heat Pump D-Box, 2 Compressors, 3-Stage TSTAT or Zone Sensor

Operation Mode	Demands				Condition	Unit Operation												
	TSTAT w/o DACC	Zone Sensor or TSTAT + DACC	Coil Sensor	Trigger		Compressor		Blower Speeds				FA Damper (Economizer)	Reversing Valve 1	Reversing Valve 1	Supp. Heat			
						1-PL	1-FL	2	Vent	C1	C2					C3	C4	Heat
Blower	G	Vent	UNOCP		OAS	OFF	OFF	OFF	X							Closed	OFF	OFF
	G	Vent	OC			OFF	OFF	OFF	X								Min_low	OFF
Free Cooling	Y1	Cstg1			Suit	OFF	OFF	OFF		X						Modulate up to Max	OFF	OFF
	Y2	Cstg2			Suit	OFF	OFF	OFF			X					Modulate up to Max	OFF	OFF
Cooling	Y2	Cstg2		damper position @ max pos & time	Suit	ON	OFF	OFF			X				Max	ON	OFF	
	Y3	Cstg3			Suit	ON	OFF	ON			X				Max	ON	OFF	
	NA	Cstg4			Suit	ON	ON	ON			X				Minimum	ON	OFF	
	Y1	Cstg1			Not Suit	OFF	OFF	OFF	X						Minimum	ON	OFF	
Heating + No Aux. Heat	NA	Cstg2			Not Suit	OFF	OFF	ON		X					Minimum	ON	OFF	
	Y2	Cstg3			Not Suit	ON	OFF	ON			X				Minimum	ON	OFF	
	Y3	Cstg4			Not Suit	ON	ON	ON				X			Minimum	ON	OFF	
	W1	Hstg1				ON	ON	ON				X			Minimum	OFF	OFF	
Heating + Elec. Heat	W2	Hstg2				ON	ON	ON				X			Minimum	OFF	OFF	
	W3	Hstg3				ON	ON	ON				X			Minimum	OFF	OFF	
	NA	Hstg4				ON	ON	ON					X		Minimum	OFF	OFF	
	W1	Hstg1				ON	ON	ON					X		Minimum	OFF	OFF	
Heating + Gas Heat	W2	Hstg2			" OAT < Bal Point"	OFF	OFF	OFF					X		Minimum	OFF	OFF	
	W3	Hstg3			" OAT < Bal Point"	OFF	OFF	OFF						X	Minimum	OFF	OFF	
	NA	Hstg4				OFF	OFF	OFF							Minimum	OFF	OFF	
	W1	Hstg1			" OAT > Bal Point"	ON	ON	ON				X			Minimum	OFF	OFF	
Defrost** Gas Heat	W2	Hstg2			" OAT > Bal Point"	OFF	OFF	OFF					X		Minimum	OFF	OFF	
	W3	Hstg3			" OAT > Bal Point"	OFF	OFF	OFF						X	Minimum	OFF	OFF	
	NA	Hstg4				OFF	OFF	OFF							Minimum	OFF	OFF	
	CMP 1		LST 1 <ΔT SP		DC	ON	ON	ON							Minimum	ON	OFF	
Defrost** Elec. Heating	CMP 2		LST 2 <ΔT SP		DC	ON	ON	ON							Minimum	ON	OFF	
	CMP 1		LST 1 <ΔT SP	@ Defrost Cycle	DC	ON	ON	ON							Minimum	ON	OFF	
CMP 2		LST 2 <ΔT SP		DC	ON	ON	ON							Minimum	ON	OFF		

** CMP 1 goes into Defrost, CMP 2 must remain in Heating, if CMP 2 goes into Defrost, CMP 1 must remain in Heating

*** For Units with 1 Stage of E Heating, only W1 and W2 will be available for Zone Sensor

26. CORE Control System - Alarms

26.1. Phase - Voltage Detection

The CORE unit controller has the ability to detect that the rooftop unit power source has the correct frequency, phasing and voltage levels. When this feature is enabled, the detection of frequency and phasing is determined at power-on and the voltage level is continuously monitored. If any of these is out of range, then an alarm is logged and the rooftop unit operation is locked out.

a. Alarms Detected at Power-On Start up:

- 121 - LINE FREQ DOES NOT MATCH UNIT CONFIG
- 126 - LINE PHASING DOES NOT MATCH UNIT CONFIG

b. Alarms - Continuously Monitoring

- 122 - 24VAC PRIMARY VOLTAGE LOW
- 123 - 24VAC PRIMARY VOLTAGE HIGH
- 124 - 24VAC SECONDARY VOLTAGE LOW
- 125 - 24VAC SECONDARY VOLTAGE HIGH

Alarms 122 through 125 are auto-resetting. The rooftop operation will be restored five (5) minutes after the proper voltage levels are restored.

Alarms 121 and 126 require removing the power and correcting the issue before restoring the rooftop operation.

The frequency (60 or 50 Hz) and the phasing (single or three-phase) of the power source is determined by the model number stored in the CORE unit controller. This model number and enabling/disabling the Phase-Voltage Detection feature can be modified through the CORE unit controller user interface. See the Installation and Setup Guide for instructions on how to configure the CONFIGURATION ID 2, Position 5.

Options are:

- N = NOT INSTALLED
- 1 = ENABLED INTERNAL (LENNOX)
- 2 = EXTERNAL (A42) PHASE DETECTION ON DI-2
- 3 = EXTERNAL (A42) PHASE DETECTION ON DI-3

When an event occurs, the CORE unit controller displays a code that corresponds to control function. Error codes are stored for recall.

NOTE: *The external A42 phase detection on DI-2 or DI-3 will generate alarm 20 PHASE MONITOR.*

26.2. Service Relay Contacts DO1

Selected alarms (marked with * in the following table result in the closure of the service relay contacts (DO1). The contacts remain closed until the CORE unit controller resets, or alarm condition is cleared and alarm status is read via explicit S-BUS command. Other modes of operation may be selected and are described in the CORE unit controller Application Guide (Advanced Features).

26.3. Alarm and Event Codes

Table 76. CORE Control System Alarm and Event Codes

SELECTED ALARMS MARKED WITH * IN TABLE RESULT IN THE CLOSURE OF THE SERVICE RELAY CONTACTS (DO1).		
ALARM CODE	DISPLAY MESSAGE	EVENT ACTION
1	ERRATIC POWER (single phase units)	<ul style="list-style-type: none"> Power loss for 50ms or raw voltage is below 15VAC. This may indicate that the unit power is dirty or is of low quality. Check power connections. The CORE unit controller will set an alarm "Erratic Power" whenever service is turned off due to detection of power loss. The CORE unit controller will shut itself down during an erratic power detection to protect its internally components and reset.
2 - 3	RESERVED	
4*	SMOKE DETECTED	A173 input is sensed as closed. Will automatically clear once input is detected open. For smoke mode, check for source of smoke. While Smoke Alarm is active, the CORE unit controller will not service any cooling, heating, or ventilation demands.
5*	BLOWER - NO AIRFLOW DETECTED	Indicates blower feedback was not received within 30 seconds after blower operation began. The CORE™ will verify blower operation by RPM feedback on direct drive motors or through a physical switch with belt-driven blower. Blower is proved within 30 seconds of blower start. If blower is not proved within 30 seconds of blower start, all compressors are de-energized, gas valves closed, electric heat turned off, economizer damper closed, and blower is stopped. Alarm will automatically clear once the error timed off delay has expired and system will resume. Check blower operation.
6*	DIRTY AIR FILTER	Dirty filter switch is detected as closed and will automatically clear after switch is detected open. Replace filter or check filter switch S27.
7	RESERVED	
8*	STRIKE 3 ON BLOWER NO AIRFLOW	Lockout is active with multiple alarm code 5 detected. Alarm can be manually cleared through the user interface. Check blower operation. Once problem is corrected, lockout alarm can be cleared by resetting the CORE unit controller.
9 - 11	RESERVED	
12	HIGH PRESSURE SWITCH COMPRESSOR 1	<ul style="list-style-type: none"> Compressor is off. Check charge, fans, and coil. <p>NOTE: On Ultra-High Efficiency units - if only Alarm 12 is present then issue could be high temperature S5 switch. If Alarm 12 is accompanied by Alarm 14 then most likely it is the high pressure S4 switch.</p> <ul style="list-style-type: none"> The unit controller will clear high pressure switch alarm when corresponding high pressure switch is detected as closed. Compressor will not restart until corresponding high pressure switch is closed and Minimum Off Delay (cooling or heating) has expired.
13*	HIGH PRESSURE STRIKE 3 COMPRESSOR 1	<ul style="list-style-type: none"> Compressor is lockout. Check charge, fans, and coil. Use service menu to clear lockouts. User will be able to clear high pressure switch compressor lockout and alarm via user interface. High pressure switch compressor lockout and alarm will be cleared after the CORE unit controller reset. High pressure switch compressor lockout and alarm will be cleared on termination of cooling demand. Default is 3 occurrences and can be set between 1 and 7 occurrences.
14	HIGH PRESSURE SWITCH COMPRESSOR 2	<ul style="list-style-type: none"> Compressor is off. Check charge, fans, or coil. This feature is not support in Model L at this time. The CORE unit controller will clear high pressure switch alarm when corresponding high pressure switch is detected as closed. Compressor will not be restarted until corresponding high pressure switch is closed and Minimum Off Delay (cooling or heating) has expired.
15*	HIGH PRESSURE STRIKE 3 - COMPRESSOR 2	<ul style="list-style-type: none"> Compressor lockout. Check charge, fans, and coil. Use service menu to clear lockouts. User will be able to clear high pressure switch compressor lockout and alarm via user interface. High pressure switch compressor lockout and alarm will be cleared after the CORE unit controller reset. High pressure switch compressor lockout and alarm will be cleared on removal of cooling demand. Default is 3 occurrences and can be set between 1 and 7 occurrences.
16	HIGH PRESSURE SWITCH - COMPRESSOR 3	<ul style="list-style-type: none"> Compressor is off. Check charge, fans, and coil. The CORE unit controller will clear high pressure switch alarm when corresponding high pressure switch is detected as closed. Compressor will not be restarted until corresponding high pressure switch is closed and Minimum Off Delay (cooling or heating) has expired.

Table 76. CORE Control System Alarm and Event Codes

SELECTED ALARMS MARKED WITH * IN TABLE RESULT IN THE CLOSURE OF THE SERVICE RELAY CONTACTS (DO1).		
ALARM CODE	DISPLAY MESSAGE	EVENT ACTION
17*	HIGH PRESSURE STRIKE 3 - COMPRESSOR 3	<ul style="list-style-type: none"> Compressor lockout. Check charge, fans, and coil. Use CORE Service application RTU > SERVICE menu to clear lockouts. User will be able to clear high pressure switch compressor lockout and alarm through the user interface. High pressure switch compressor lockout and alarm will be cleared after the CORE unit controller reset. High pressure switch compressor lockout and alarm is cleared on removal of cooling demand. Default is 3 occurrences and can be set between 1 and 7 occurrences.
18	HIGH PRESSURE SWITCH - COMPRESSOR 4	<ul style="list-style-type: none"> Compressor lockout. Check charge, fans, and coil. The CORE unit controller will clear high pressure switch alarm when corresponding high pressure switch is detected as closed. Compressor will not be restarted until corresponding high pressure switch is closed and Minimum Off Delay (cooling or heating) has expired.
19*	HIGH PRESSURE STRIKE 3 - COMPRESSOR 4	<ul style="list-style-type: none"> Compressor lockout. Check charge, fans and coil. Use service menu to clear lockouts. User will be able to clear high pressure switch compressor lockout and alarm via user interface. High pressure switch compressor lockout and alarm will be cleared after the CORE unit controller reset. High pressure switch compressor lockout and alarm is cleared on removal of cooling demand. Default is 3 occurrences and can be set between 1 and 7 occurrences.
20	PHASE MONITOR FAULT	External phase monitor is indicating an issue.
21	RESERVED	
22	LOW PRESSURE SWITCH COMPRESSOR 1	Compressor is off. Check charge, fans and coil. Use service menu to clear lockouts.
23*	STRIKE 3 LOW PRESSURE COMPRESSOR 1	<ul style="list-style-type: none"> Compressor is off. Check charge, fans and coil. Use service menu to clear lockouts. Number of occurrences is set using Parameter 99 (max lo occurrences). Default is 3 occurrences.
24	LOW PRESSURE SWITCH COMPRESSOR 2	Compressor is off. Check charge, fans and coil.
25*	STRIKE 3 LOW PRESSURE COMPRESSOR 2	<ul style="list-style-type: none"> Compressor is off. Check charge, fans and coil. Use service menu to clear lockouts. Number of occurrences is set using Parameter 99 (max lo occurrences). Default is 3 occurrences.
26	LOW PRESSURE SWITCH COMPRESSOR 3	Compressor if off. Check charge, fans and coil.
27*	STRIKE 3 LOW PRESSURE COMPRESSOR 3	<ul style="list-style-type: none"> Compressor is off. Check charge, fans and coil. Use service menu to clear lockouts. Number of occurrences is set using Parameter 99 (max lo occurrences). Default is 3 occurrences.
28	LOW PRESSURE SWITCH COMPRESSOR 4	Compressor if off. Check charge, fans and coil.
29*	STRIKE 3 LOW PRESSURE COMPRESSOR 4	<ul style="list-style-type: none"> Compressor is off. Check charge, fans and coil. Use service menu to clear lockouts. Number of occurrences is set using Parameter 99 (max lo occurrences). Default is 3 occurrences.
30*	DRAIN PAN OVERFLOW SWITCH	<ul style="list-style-type: none"> Check for block drain, condensate lines and drain pan overflow switch. Alarm set if overflow switch is detected opened and compressor will be locked out. System will automatically clear alarm once switch is detected closed. System will resume operation (compressor lockout), after the Error Timed OFF Delay has expired following the Overflow switch alarm clear.
31	RESERVED	
32	EVAPORATOR FROZEN COMPRESSOR 1	Compressor is off. Check SST sensor, air flow, charge, coil, air filter and outside air temperature.
33*	STRIKE 3 EVAPORATOR FROZEN COMPRESSOR 1	<ul style="list-style-type: none"> Compressor is locked out. Check SST sensor, air flow, charge, coil, air filter and outside air temperature. Number of occurrences is set using Parameter 81 (max freeze stat occ). Default is 3 occurrences.
34	EVAPORATOR FROZEN COMPRESSOR 2	Compressor is off. Check SST sensor, air flow, charge, coil, air filter and outside air temperature.

Table 76. CORE Control System Alarm and Event Codes

SELECTED ALARMS MARKED WITH * IN TABLE RESULT IN THE CLOSURE OF THE SERVICE RELAY CONTACTS (DO1).		
ALARM CODE	DISPLAY MESSAGE	EVENT ACTION
35*	STRIKE 3 EVAPORATOR FROZEN COMPRESSOR 2	<ul style="list-style-type: none"> Compressor is locked out. Check SST sensor, air flow, charge, coil, air filter, and outside air temperature. Number of occurrences is set using Parameter 81 (max freeze stat occ). Default is 3 occurrences.
36	EVAPORATOR FROZEN COMPRESSOR 3	Compressor is off. Check SST sensor, air flow, charge, coil, air filter, and outside air temperature.
37*	STRIKE 3 EVAPORATOR FROZEN COMPRESSOR 3	<ul style="list-style-type: none"> Compressor is locked out. Check SST sensor, air flow, charge, coil, air filter, and outside air temperature. Number of occurrences is set using Parameter 81 (max freeze stat occ). Default is 3 occurrences.
38	EVAPORATOR FROZEN COMPRESSOR 4	Compressor is off. Check SST sensor, air flow, charge, coil, air filter, and outside air temperature.
39*	STRIKE 3 EVAPORATOR FROZEN COMPRESSOR 4	<ul style="list-style-type: none"> Compressor is locked out. Check SST sensor, air flow, charge, coil, air filter and outside air temperature. Number of occurrences is set using Parameter 81 (max freeze stat occ). Default is 3 occurrences.
40	RETURN AIR OVER HEAT LIMIT	Heat is above setpoint as defined by parameter 115.
41	RETURN AIR UNDER COOL LIMIT	Cool is below setpoint as defined by parameter 114.
42	BLOWER MOTOR OVERLOAD	Blower motor is overloaded. System shutdown.
43	RESERVED	
44*	GAS VALVE ON NO DEMAND GV1	Unit is off. Gas valve 1 has power, but no demand. Check gas valve and wiring.
45*	GAS VALVE ON NO DEMAND GV2	Unit is off. Gas valve 2 has power, but no demand. Check gas valve and wiring.
46 - 48	RESERVED	
49	NO 24VAC POWER ON C3	No 24VAC relay power On A59 (C2) Board, TB35-1 Input. (A59)
50	PRIMARY HEAT 1 LIMIT OPEN S10	Heat section 1 primary gas heat limit switch is open. Check air flow, air filter, limit switch, and wiring.
51*	STRIKE 3 PRIMARY HEAT 1 LIMIT OPEN	Heat section 1 primary gas heat limit switch is open. Check air flow, air filter, limit switch, and wiring. Number of occurrences is reached.
52	SECONDARY HEAT 1 LIMIT OPEN S21	Heat section 1 secondary gas heat limit switch is open. Check air flow, air filter, limit switch and wiring.
53	STRIKE3 SEC HEAT LIMIT OPEN	Heat section 1 secondary gas heat limit switch has opened 3 (default) times during a demand.
54	HEAT 1 S15 LIMIT OR ROLLOUT OPEN	Heat section 1 primary electric heat limit switch is open. Check air flow, air filter, limit switch, and wiring.
55*	STRIKE 3 HEAT 1 S15 LIMIT OR ROLL OUT	Heat section 1 flame roll out burner 1 switch is open. Check gas roll out switch S47.
56	HEAT 1 CAI SWITCH S18	Check heat section 1 combustion air motor and proof switch.
57*	STRIKE 3 HEAT 1 CAI SWITCH S18	Check heat section 1 combustion air motor and proof switch. Number of occurrences is reached.
58	HEAT 1 NO PROOF GV1	Check heat section 1 ignition control, flame proof, gas valve 1, and gas supply.
59*	STRIKE 3 HEAT 1 NO PROOF GV1	Check heat section 1 ignition control, flame proof, gas valve 1, and gas supply. Number of occurrences is reached.
60	PRIMARY HEAT 2 LIMIT OPEN S99	Check heat section 2 primary burner limit switch to see if it is open. Check air flow, limit switch, and wiring.
61*	STRIKE 3 PRIMARY HEAT LIMIT OPEN	Check heat section 2 primary burner limit switch to see if it is open. Check air flow, limit switch, and wiring. Number of occurrences is reached.
62	SECONDARY HEAT 2 LIMIT OPEN S100	Heat section 2 secondary heat limit switch is open. Check air flow, limit switch, and wiring.
63	STRIKE3 SEC HEAT LIMIT OPEN	Heat section 2 secondary gas heat limit switch has opened 3 (default) times during a demand.
64	HEAT 2 CAI SWITCH S45 HEAT 2 ROLLOUT OPEN	Flames have been detected outside the gas heater's fire box.
65*	STRIKE 3 HEAT 2 ROLL OUT OPEN	Check roll out sensor and gas supply.
66	HEAT 2 CAI SWITCH S45	Check heat section 2 combustion air motor and proof switch.
67*	STRIKE 3 HEAT 2 CAI SWITCH S45	Check heat section 2 combustion air motor and proof switch. Number of occurrences is reached.

Table 76. CORE Control System Alarm and Event Codes

SELECTED ALARMS MARKED WITH * IN TABLE RESULT IN THE CLOSURE OF THE SERVICE RELAY CONTACTS (DO1).		
ALARM CODE	DISPLAY MESSAGE	EVENT ACTION
68	HEAT 2 NO PROOF GV2	Check heat section 2 ignition control, flame roof, gas valve 2, and gas supply
69*	STRIKE 3 HEAT 2 NO PROOF GV3	Check heat section 2 ignition control, flame roof, gas valve 2, and gas supply. Number of occurrences is reached.
70	RESERVED	
71	COMPRESSOR 1 PROTECTION SHUTDOWN	Compressor 1 has been shut down by the rpm limiter protection system to prevent equipment damage. This alarm triggers when operating conditions (high input current, low suction pressure, high discharge temperature, compressor map edge limits, or high saturated discharge temperature) exceed safe limits and the system cannot stabilize by reducing rpm. Check refrigerant levels, airflow, and system pressures to identify and correct the underlying issue before clearing the alarm.
72	COMPRESSOR 2 PROTECTION SHUTDOWN	Compressor 2 has been shut down by the RPM limiter protection system to prevent equipment damage. This alarm triggers when operating conditions (high input current, low suction pressure, high discharge temperature, compressor map edge limits, or high saturated discharge temperature) exceed safe limits and the system cannot stabilize by reducing RPM. Check refrigerant levels, airflow, and system pressures to identify and correct the underlying issue before clearing the alarm.
73	NETWORK SENSOR	Check with integrator for refresh rate, network status lights, and wiring.
74*	ZONE SENSOR	<ul style="list-style-type: none"> • If measurement is out of specified range (including open/short detection) the system will ignore the Zone Temperature Sensor readings and set the alarm. • If measurement of Zone Temperature Sensor is out of specified range (including open/short detection) the system will change operating mode to the specified Backup mode (None, Local Thermistor or Return Air temp). • The system will clear the alarm, if zone temperature sensor measurement is detected in specified operating range and return the system to monitoring the A2 sensor as the primary sensor input. • Check zone (room) sensor and wiring.
75*	OUTDOOR TEMP SENSOR	<ul style="list-style-type: none"> • If measurement of the outdoor temperature sensor is out of specified range (including open / short detection) the alarm will be activated. Alarm will automatically clear once in range condition is detected. • Check sensor and wiring.
76*	HUMIDITY SENSOR	<ul style="list-style-type: none"> • If measurement is below specified range (<5 % RH) the system will ignore the Relative Humidity readings. If measurement is above the specified range (>100% RH) the system will limit the value to 100%. • If measurement of Relative Humidity Sensor is below specified range while the dehumidification mode using RH sensor is enabled, the system will set an alarm. The system will clear the alarm if Relative Humidity sensor measurement is detected in specified operating range OR dehumidification mode using RH sensor is disabled. • Check sensor and wiring.
77*	DISCHARGE AIR TEMP SENSOR	<ul style="list-style-type: none"> • If measurement of the discharge air temperature sensor is out of specified range (including open / short detection) the alarm will be activated. Alarm will automatically clear once in range condition is detected. • Check sensor and wiring.
78*	RETURN AIR TEMP SENSOR	<ul style="list-style-type: none"> • If measurement of the return air temperature sensor is out of specified range (including open / short detection) the alarm will be activated. Alarm will automatically clear once in range condition is detected. • Check sensor and wiring.
79*	ID ADD ON BOARD PROBLEM	Add-on board problem, reset CORE unit controller to clear. When the communication Alarm 80 persists for more than 30 seconds even after several retries for establishing the communication this alarm is logged. Alarm can only be cleared by CORE unit controller reset.
80	ID ADD ON BOARD PROBLEM	When the CORE unit controller is not able to communicate with any attached add-on boards (C3 and GP3), this alarm code is logged. The CORE unit controller will retry to establish the communication once every 5 seconds. Alarm is automatically cleared once communication is restored.
81	REHEAT SETUP ERROR	Check reheat settings. Alarm 81 is raised under these two conditions: <ol style="list-style-type: none"> 1. If the user sets up the unit to use supermarket reheat on a non-gas unit. 2. If the user sets up the unit to use Humiditrol+ reheat but the heater type is heat pump.
82	CONTROLLER RESET	The reason (if known) for the reset displays after the M4 unit controller resets.
83	INCORRECT SETTINGS	Check system configuration.
84	RESERVED	

Table 76. CORE Control System Alarm and Event Codes

SELECTED ALARMS MARKED WITH * IN TABLE RESULT IN THE CLOSURE OF THE SERVICE RELAY CONTACTS (DO1).		
ALARM CODE	DISPLAY MESSAGE	EVENT ACTION
85	INCORRECT HUMIDITROL	Check Humiditrol+ settings. Check Configuration ID 1, position 1 and verify that the position is not set to U. Should be set to either N (not installed) or H (Humiditrol). Alarm will automatically clear once correct option is set.
86*	CONFLICTING TSTAT INPUT	Check thermostat inputs for simultaneous heat and cooling wiring. Once condition is corrected, unit controller will resume operation after error time off day has expired.
87	RESERVED	
88 - 90	RESERVED	
91*	OUTDOOR ENTHALPY SENSOR	<ul style="list-style-type: none"> If Enthalpy Sensor failure is detected, the system will disable 'Free Cooling' operation. <p>NOTE: Valid Outdoor Enthalpy Sensor reading is required for both 'ODE' (Outdoor Enthalpy) and 'ODE differential' (Outdoor differential). Valid Indoor Enthalpy Sensor reading is required for 'ODE differential' (Outdoor differential).</p> <ul style="list-style-type: none"> Check economizer Parameters 160 and 161. Also check enthalpy Parameters 162 and 163. Check sensor and wiring.
92*	INDOOR ENTHALPY SENSOR	<ul style="list-style-type: none"> If Enthalpy Sensor failure is detected, the system will disable 'Free Cooling' operation. <p>NOTE: Valid Outdoor Enthalpy Sensor reading is required for both 'ODE' (Outdoor Enthalpy) and 'ODE differential' (Outdoor differential). Valid Indoor Enthalpy Sensor reading is required for 'ODE differential' (Outdoor differential).</p> <ul style="list-style-type: none"> Check wiring and test A62 sensor using specified method in CORE application guide, section titled economizer checkout.
93*	UNIT OPERATING IN BACKUP MODE	<ul style="list-style-type: none"> Check communication loss with network sensor or if CORE unit controller. Check if NETWORK INTEGRATION is set to RTU STANDALONE MODE and backup sensor is set to RETURN AIR BACKUP. While running in backup mode, the unit controller will set this alarm. The unit controller will return from Backup mode to Primary (Main) mode on a reset or after the Primary mode (room Sensor is not in error or OR network communication is re-established and available for 300 seconds. Backup mode alarm will be cleared on the reset OR after the unit controller has returned to primary (main) system mode.
94*	ZONE SETPOINT ERROR	Ensure that the heating and cooling setpoints honor the auto-changeover deadband.
95 - 98	RESERVED	
99*	OUTSIDE AIR VELOCITY SENSOR ERROR	Check sensor and wiring. This alarm activates when the A24 sensor input signal is continuously above 25% of sensor measuring range for more than five minutes with the blower stopped. The CORE unit controller will disable the Outdoor Air CFM control. The alarm automatically clears when the sensor reading is below 10% sensor measuring range for one minute.
100	RESERVED	
101	RESERVED	
102	RESERVED	
103*	ADVANCED CONTROL SETUP ERROR	Check CORE unit controller Configuration ID 1 settings.
104	RESERVED	
105	RESERVED	
106*	BUILDING PRESSURE SENSOR PROBLEM	Check sensor and wiring.
107*	DUCT SUPPLY PRESS SENSOR PROBLEM	<p>Check sensor and wiring.</p> <p>The unit controller will set Supply Air Static Pressure Sensor (A30) error status if:</p> <ul style="list-style-type: none"> Input signal is above 4.9" wc for more than 30 seconds. <p>OR</p> <ul style="list-style-type: none"> Input signal is below 0.1"wc 20 seconds after the blower has started with setting at or above Blower Output Static Duct Alarm Check. <p>The CORE unit controller will clear the Supply Air Static Pressure Sensor (A30) error status and alarm after the expiration of Error Time OFF delay.</p>

Table 76. CORE Control System Alarm and Event Codes

SELECTED ALARMS MARKED WITH * IN TABLE RESULT IN THE CLOSURE OF THE SERVICE RELAY CONTACTS (DO1).		
ALARM CODE	DISPLAY MESSAGE	EVENT ACTION
108	SUPPLY DUCT PRESS LIMIT EXCEEDED	<ul style="list-style-type: none"> Check sensor and wiring. The CORE unit controller will shutdown operation for Error Off time (Parameter 110) if supply air static pressure exceeds supply static shutdown setpoint for 20 seconds (default) Parameter 42. The CORE unit controller will clear High Supply Static (Duct) Pressure after Error Off Time has expired and static duct pressure is below Supply Static Setpoint Shutdown.
109*	STRIKE 3 SUPPLY DUCT PRESSURE LIMIT	<ul style="list-style-type: none"> Check sensor and wiring. Unit controller will "lockout" a unit operation after the Max Static Duct Pressure Occurrences have occurred of Supply Static Pressure Sensor Error (alarm 107) and/or High Supply Static (Duct) Pressure (Alarm 108). User will be able to clear supply static pressure lockout and alarm via User Interface. Supply Static Pressure lockout and alarm will be cleared after the unit controller reset. The number of strikes is three by default. This can be changed using Parameter 43. Optional occurrence setting is 1 to 7.
110	WAITING ON SENSOR DATA	Check network or comfort sensor and wiring.
111	PROFILE ERROR	Configuration profile unrecoverable. Settings may have changed.
112 - 119	RESERVED	
120	FIRMWARE UPDATE FAILURE	Verify the correct firmware file is loaded. Check USB for the file in \Firmware\M4\
121*	LINE FREQUENCY MISMATCH	Power source line frequency is determined by the entered model number. This alarm is enabled by the Phase Voltage Detection feature. The CORE unit controller does not have an automatic clearing method. Cycle power or reset the unit to re-evaluate the phase sequence.
122*	24VAC PRIMARY VOLTAGE LOW	<ul style="list-style-type: none"> Low output voltage on T1 transformer. Alarm set when 24VAC voltage low if calculated RMS voltage is below low voltage alarm threshold for more than two seconds. System will stop unit operations (cooling, heating and ventilation). Low voltage threshold is 18VAC. The CORE unit controller will clear alarm 24VAC Voltage Low if calculated RMS voltage is above Low Voltage Alarm Threshold + 1 VAC for more than two seconds. After the low 24VAC alarm has been cleared, the CORE unit controller will ignore all service demands until the Error Time Off Delay has expired.
123*	24VAC PRIMARY VOLTAGE HIGH	<ul style="list-style-type: none"> High output voltage on T1 transformer. Alarm set when 24VAC voltage high if calculated RMS voltage is below low voltage alarm threshold for more than two seconds. System will stop unit operations (cooling, heating and ventilation). Low voltage threshold is 30VAC. The CORE unit controller will clear alarm 24VAC Voltage high if calculated RMS voltage is above High Voltage Alarm Threshold + 1 VAC for more than two seconds. After the HIGH 24VAC alarm has been cleared, the CORE unit controller will ignore all service demands until the Error Time Off Delay has expired.
124*	24VAC SECONDARY VOLTAGE LOW	<ul style="list-style-type: none"> Low output voltage on T1 transformer. Alarm set when 24VAC voltage low if calculated RMS voltage is below low voltage alarm threshold for more than two seconds. System will stop unit operations (cooling, heating and ventilation). Low voltage threshold is 18VAC. The CORE unit controller will clear alarm 24VAC voltage low if calculated RMS voltage is above Low Voltage Alarm Threshold + 1 VAC for more than two seconds. After the low 24VAC alarm has been cleared, the CORE unit controller will ignore all service demands until the Error Time Off Delay has expired.
125*	24VAC SECONDARY VOLTAGE HIGH	<ul style="list-style-type: none"> High output voltage on T1 transformer. Alarm set when 24VAC voltage high if calculated RMS voltage is below low voltage alarm threshold for more than two seconds. System will stop unit operations (cooling, heating and ventilation). Low voltage threshold is 30VAC. The CORE unit controller will clear alarm 24VAC Voltage HIGH if calculated RMS voltage is above high voltage alarm Threshold + 1 VAC for more than two seconds. After the high 24VAC alarm has been cleared the CORE unit controller will ignore all service demands until the Error Time Off Delay has expired.
126*	LINE PHASING MISMATCH	During power up or reset of unit, mismatch on single or 3 phase power, or reverse rotation on 3 phase detected. This alarm is enabled by the Phase Voltage Detection feature.
127	RESERVED	
128	RESERVED	

Table 76. CORE Control System Alarm and Event Codes

SELECTED ALARMS MARKED WITH * IN TABLE RESULT IN THE CLOSURE OF THE SERVICE RELAY CONTACTS (DO1).		
ALARM CODE	DISPLAY MESSAGE	EVENT ACTION
129*	VFD SHUTDOWN	<ul style="list-style-type: none"> Indoor blower VFD fault detected. The CORE Control System will monitor the motor status ten seconds after blower command is sent. The CORE unit controller will stop unit operation if fault conditions are detected. Check belt and for blower overload. Fix source of fault and cycle power to the RTU.
130	VFD BYPASS ENGAGED	VFD bypass mode. Mode is engaged. Blower may or may not be disengaged.
131	RESERVED	
132	VFD BYPASS UNCONFIGURED	VFD bypass mode has not been selected. Unit operates as if bypass is not installed.
133	RESERVED	
134	LOW SUPPLY AIRFLOW	RTU indicates airflow target cannot be achieved.
135	NO SUPPLY AIRFLOW	Blower RPM is too low indicating that the blower is not working.
136	OA DAMPER MECH FAULT	Outdoor air damper stuck or actuator problem.
137	DAMPER STUCK CLOSED	<ul style="list-style-type: none"> The damper is not opening to the target percentage. Unit may be bringing in less than anticipated outdoor air. Inspect damper and / or actuator for blockage. Alarm is raised when damper actuator feedback exceeds 2v under target for 2 minutes. Alarm will reset automatically when damper feedback falls to 1.8v within the target voltage.
138	RESERVED	
139	DAMPER STUCK OPEN	<ul style="list-style-type: none"> The Damper is not closing to the target percentage. Unit may be bringing in more than anticipated outdoor air. Inspect damper and / or actuator for blockage. Alarm is raised when damper actuator feedback exceeds 2v under target for 2 minutes. Alarm will reset automatically when damper feedback falls to 1.8v within the target voltage.
140	CFM TARGET TOO LOW	CFM Unattainable. Verify the MSAV blower settings and set the CM targets below set CFM.
141	CFM TARGET TOO HIGH	CFM Unattainable. Verify the MSAV blower settings and set the CM targets below set CFM.
142	RESERVED	
143	OA DAMPER ERROR	Outdoor air differential pressure sensor value not in valid range.
144	RESERVED	
145	RESERVED	
146	SERVICE EVENT	Service event logged.
147*	DAMPER FEEDBACK LOSS	During free cooling damper is not modulating.
148*	ADV AIRFLOW CONFIG ERROR	Economizer should be installed and blower should be ecm type.
149*	OA DIFF PRESS SENSOR ERROR	Check outdoor air damper differential pressure sensor and wiring.
150*	NOT ECONOMIZING WHEN OAS	May be due to the damper motor being unplugged or disconnected.
151*	ECONOMIZING WHEN OANS	This may be due to damper motor being blocked or stuck open and therefore not closing.
152	A2L SENSOR LEAK	Check for 454A leaks.
153	A2L SENSOR LEAK	Check for 454A leaks.
154 - 162	RESERVED	
163	LIQUID PRESSURE SENSOR OPEN	Sensor reading is outside the valid range.
164	STRIKE 3 LIQUID PRESSURE SENOR OPEN	Sensor reading is outside the valid range.
165	ECONOMIZER UNCONFIGURED	Configuration ID 1, position 2 is set to U. Select applicable option using setup/install wizard.
166	GAS CAP NO OPEN PROOF GV1	This alarm occurs when the combustion air pressure switch (S18) is detected as closed immediately after the furnace demand relay is energized and before the combustion air blower is energized. Gas valve 1.
167	GAS CAP NO OPEN PROOF GV2	This alarm occurs when the combustion air pressure switch (S45) is detected as closed immediately after the furnace demand relay is energized and before the combustion air blower is energized. Gas valve 2.
168	GAS CAP NO OPEN PROOF LOCK-OUT GV1	This alarm occurs when the combustion air pressure switch (S18) is detected as closed immediately after the furnace demand relay is energized and before the combustion air blower is energized. Gas valve 1

Table 76. CORE Control System Alarm and Event Codes

SELECTED ALARMS MARKED WITH * IN TABLE RESULT IN THE CLOSURE OF THE SERVICE RELAY CONTACTS (DO1).		
ALARM CODE	DISPLAY MESSAGE	EVENT ACTION
169	GAS CAP NO OPEN PROOF LOCK-OUT GV2	This alarm occurs when the combustion air pressure switch (S45) is detected as closed immediately after the furnace demand relay is energized and before the combustion air blower is energized. Gas valve 2.
170	POWER EXHAUST UNCONFIGURED	Configuration ID 1, position 3 is set as U (Unconfigured).
171	POWER EXHAUST CONFIGURATION ERROR	Configuration ID 1, position 4 is set correctly. If position 3 is configured then position 4 must be also.
172	EP UNCONFIGURED	Economizer should be installed and blower should be ECM type.
173	AIRFLOW SWITCH CONFIGURATION ERROR	Verify that Configuration ID 2, position 1 is set correctly.
174	BYPASS DAMPER CONFIGURATION ERROR	Room bypass damper operation should only be used if blower is configured for CAV operation. Unit Controller will only allow zone bypass unit operation if configuration ID1 is set correctly. Alarm will automatically clear when configuration conflict is corrected.
175	NO INPUT SHARING	Alarm will occur if load shedding input is shared with other optional devices or inputs, for example - global, blower overload, drain pan overflow, etc.
176	SBUS OBSOLETE M2 COMMAND	This alarm occurs when a S-BUS primary device sends a M2 style command to the CORE unit controller. The alarm is immediately cleared and a history of the event is stored.
177	NO MODEL NUMBER	Missing model configuration data. Run setup > install and complete model number information.
178 - 181	RESERVED	
182	SUCTION PRESSURE SENSOR	Sensor reading is outside the valid range.
183	COMP1 SUMP TEMP SENSOR	Sensor reading is outside the valid range.
184	COMP2 SUMP TEMP SENSOR	Sensor reading is outside the valid range.
185	ULTRA ALARM	Generic alarm for ultra issues. The alarming value will have different values for different issues
186*	BLOWER MOTOR FAULT	<p>DirectPlus™ blower fault detected. The CORE Control System will monitor the motor status ten seconds after blower command is sent. The CORE unit controller will stop unit operation if fault conditions are detected.</p> <p>Fix source of fault and reset (reboot) CORE unit controller.</p> <p>NOTE: For blowers connected via MODBUS, the alarming Value = any present motor alarms. Sum of the error numbers equals the current fault, for example 48 means motor overheated (32 + 16):</p> <p>1 - Phase failure (3-phase devices) or mains under voltage (1-phase devices) 4 - Power module overheated 8 - Communication error between CORE unit controller and blower 16 - Fan bad (general error, set with every error condition) 32 - Motor overheated 64 - Hall sensor error 128 - Locked motor 4096 - DC-link under voltage</p>
187	INVERTER MINOR	<ul style="list-style-type: none"> Alarming Value = Inverter error code Possible alarming values for Alarm 187 on the LG inverter are: <ul style="list-style-type: none"> > 12 - High Comp Current > 13 - High Heat sink temperature > 14 - High PFC input current If the alarm continues after outdoor conditions have moderated, check the fan, charge, and coil. Alarm 187 will automatically clear when minimum off time expires. Refer to trouble shooting guide in service manual for more information. <p>NOTE: The inverter will automatically slow the compressor speed due to any of the above conditions and the condition drops below the time-based dependence of the system's output on present and past inputs.</p>

Table 76. CORE Control System Alarm and Event Codes

SELECTED ALARMS MARKED WITH * IN TABLE RESULT IN THE CLOSURE OF THE SERVICE RELAY CONTACTS (DO1).																																			
ALARM CODE	DISPLAY MESSAGE	EVENT ACTION																																	
188	INVERTER MAJOR	<ul style="list-style-type: none"> Alarming Value = Inverter error code LG Inverter: Possible alarming values for unit controller Alarm 188: <ul style="list-style-type: none"> > 21 - Peak DC current > 22 - Maximum current reached lockout > 23 - DC Link low voltage > 26 - Locked Rotor > 28 - DC Link high voltage > 29 - Compressor over current > 61 - Low outdoor ambient inverter lockout > 62 - High Heat Sink Temperature lockout > 75 - Low Input Voltage Copeland Inverter: <p>NOTE: If X = 1, the alert is referencing Compressor 1. If X = 2, the alert is referencing Compressor 2.</p> <table border="1"> <tr> <td>> X001 - Over Current</td> <td>> X019 - PWR BRD EEPROM</td> <td>> X103 - Drive Over Temp</td> </tr> <tr> <td>> X002 - Over Voltage</td> <td>> X020 - MCU EEPROM</td> <td>> X137 - Foldback Active <i>Note: Possibly due to fan not running.</i></td> </tr> <tr> <td>> X003 - Earth Fault</td> <td>> X021 - SFlash Warning</td> <td>> X138 - IGBT Foldback Fault</td> </tr> <tr> <td>> X009 - Under Voltage</td> <td>> X023 - STO Circuit</td> <td></td> </tr> <tr> <td>> X010 - Input Phase</td> <td>> X025 - MCU Watchdog</td> <td></td> </tr> <tr> <td>> X011 - Output Phase</td> <td>> X041 - IGBT Over Temp</td> <td></td> </tr> <tr> <td>> X013 - Under Temp</td> <td>> X053 - Demand Update Failure</td> <td></td> </tr> <tr> <td>> X014 - Over Temp</td> <td>> X066 - Safety Torque Off</td> <td></td> </tr> <tr> <td>> X015 - Motor Stalled</td> <td>> X070 - System Fault</td> <td></td> </tr> <tr> <td>> X016 - Motor Overload</td> <td>> X083 - Field Bus Fault</td> <td></td> </tr> <tr> <td>> X017 - Motor Underload</td> <td>> X090 - Drive Under Temp</td> <td></td> </tr> </table> <ul style="list-style-type: none"> No action required. Compressor stops for the duration of the minimum run time. Unit shuts down after ten occurrences in one hour and Alarm 189 is initiated. Alarm 188 will automatically clear when inverter error clears. Refer to trouble shooting guide in service manual for more information. 	> X001 - Over Current	> X019 - PWR BRD EEPROM	> X103 - Drive Over Temp	> X002 - Over Voltage	> X020 - MCU EEPROM	> X137 - Foldback Active <i>Note: Possibly due to fan not running.</i>	> X003 - Earth Fault	> X021 - SFlash Warning	> X138 - IGBT Foldback Fault	> X009 - Under Voltage	> X023 - STO Circuit		> X010 - Input Phase	> X025 - MCU Watchdog		> X011 - Output Phase	> X041 - IGBT Over Temp		> X013 - Under Temp	> X053 - Demand Update Failure		> X014 - Over Temp	> X066 - Safety Torque Off		> X015 - Motor Stalled	> X070 - System Fault		> X016 - Motor Overload	> X083 - Field Bus Fault		> X017 - Motor Underload	> X090 - Drive Under Temp	
> X001 - Over Current	> X019 - PWR BRD EEPROM	> X103 - Drive Over Temp																																	
> X002 - Over Voltage	> X020 - MCU EEPROM	> X137 - Foldback Active <i>Note: Possibly due to fan not running.</i>																																	
> X003 - Earth Fault	> X021 - SFlash Warning	> X138 - IGBT Foldback Fault																																	
> X009 - Under Voltage	> X023 - STO Circuit																																		
> X010 - Input Phase	> X025 - MCU Watchdog																																		
> X011 - Output Phase	> X041 - IGBT Over Temp																																		
> X013 - Under Temp	> X053 - Demand Update Failure																																		
> X014 - Over Temp	> X066 - Safety Torque Off																																		
> X015 - Motor Stalled	> X070 - System Fault																																		
> X016 - Motor Overload	> X083 - Field Bus Fault																																		
> X017 - Motor Underload	> X090 - Drive Under Temp																																		

Table 76. CORE Control System Alarm and Event Codes

SELECTED ALARMS MARKED WITH * IN TABLE RESULT IN THE CLOSURE OF THE SERVICE RELAY CONTACTS (DO1).																																			
ALARM CODE	DISPLAY MESSAGE	EVENT ACTION																																	
189	INVERTER FATAL	<ul style="list-style-type: none"> Alarming Value = Inverter error code LG Inverter: Possible alarming values for alarm 189 are: <ul style="list-style-type: none"> > 21 - Peak DC current > 22 - Maximum current reached lockout > 23 - DC Link low voltage > 26 - Locked Rotor > 28 - DC Link high voltage > 29 - Compressor over current > 61 - Low outdoor ambient inverter lockout > 62 - High Heat Sink Temperature lockout > 75 - Low Input Voltage Copeland Inverter: <p>NOTE: If X = 1, the alert is referencing Compressor 1. If X = 2, the alert is referencing Compressor 2.</p> <table border="1"> <tr> <td>> X001 - Over Current</td> <td>> X019 - PWR BRD EEPROM</td> <td>> X103 - Drive Over Temp</td> </tr> <tr> <td>> X002 - Over Voltage</td> <td>> X020 - MCU EEPROM</td> <td>> X137 - Foldback Active <i>Note: Possibly due to fan not running.</i></td> </tr> <tr> <td>> X003 - Earth Fault</td> <td>> X021 - SFlash Warning</td> <td>> X138 - IGBT Foldback Fault</td> </tr> <tr> <td>> X009 - Under Voltage</td> <td>> X023 - STO Circuit</td> <td></td> </tr> <tr> <td>> X010 - Input Phase</td> <td>> X025 - MCU Watchdog</td> <td></td> </tr> <tr> <td>> X011 - Output Phase</td> <td>> X041 - IGBT Over Temp</td> <td></td> </tr> <tr> <td>> X013 - Under Temp</td> <td>> X053 - Demand Update Failure</td> <td></td> </tr> <tr> <td>> X014 - Over Temp</td> <td>> X066 - Safety Torque Off</td> <td></td> </tr> <tr> <td>> X015 - Motor Stalled</td> <td>> X070 - System Fault</td> <td></td> </tr> <tr> <td>> X016 - Motor Overload</td> <td>> X083 - Field Bus Fault</td> <td></td> </tr> <tr> <td>> X017 - Motor Underload</td> <td>> X090 - Drive Under Temp</td> <td></td> </tr> </table> <ul style="list-style-type: none"> Alarm 189 will clear upon manual reset. Refer to trouble shooting guide in service manual for more information. 	> X001 - Over Current	> X019 - PWR BRD EEPROM	> X103 - Drive Over Temp	> X002 - Over Voltage	> X020 - MCU EEPROM	> X137 - Foldback Active <i>Note: Possibly due to fan not running.</i>	> X003 - Earth Fault	> X021 - SFlash Warning	> X138 - IGBT Foldback Fault	> X009 - Under Voltage	> X023 - STO Circuit		> X010 - Input Phase	> X025 - MCU Watchdog		> X011 - Output Phase	> X041 - IGBT Over Temp		> X013 - Under Temp	> X053 - Demand Update Failure		> X014 - Over Temp	> X066 - Safety Torque Off		> X015 - Motor Stalled	> X070 - System Fault		> X016 - Motor Overload	> X083 - Field Bus Fault		> X017 - Motor Underload	> X090 - Drive Under Temp	
> X001 - Over Current	> X019 - PWR BRD EEPROM	> X103 - Drive Over Temp																																	
> X002 - Over Voltage	> X020 - MCU EEPROM	> X137 - Foldback Active <i>Note: Possibly due to fan not running.</i>																																	
> X003 - Earth Fault	> X021 - SFlash Warning	> X138 - IGBT Foldback Fault																																	
> X009 - Under Voltage	> X023 - STO Circuit																																		
> X010 - Input Phase	> X025 - MCU Watchdog																																		
> X011 - Output Phase	> X041 - IGBT Over Temp																																		
> X013 - Under Temp	> X053 - Demand Update Failure																																		
> X014 - Over Temp	> X066 - Safety Torque Off																																		
> X015 - Motor Stalled	> X070 - System Fault																																		
> X016 - Motor Overload	> X083 - Field Bus Fault																																		
> X017 - Motor Underload	> X090 - Drive Under Temp																																		
190	INVERTER COMMUNICATION ERROR	<p>Unable to communicate with inverter. The unit controller disables compressor operation.</p> <p>LG Inverter: Replace communication cable between inverter and CORE unit controller. If alarm continues, replace CORE unit controller or inverter.</p> <p>Copeland Inverter: X500</p>																																	
191	INVERTER VOLTAGE MISMATCH	<p>The unit controller disables compressor operation.</p> <p>LG Inverter: Replace with correct inverter part.</p> <p>Copeland Inverter: X000</p>																																	
192	HIGH TEMPERATURE (S7) COMPRESSOR 1	<p>Check temperature trip switch. Compressor is off. Also check charge, fans, and coil. The unit controller clears the temperature trip alarm when corresponding compressor top cap temperature trip switch is detected as closed. Compressor will not restart until the corresponding temperature trip switch is closed and the minimum off delay has expired.</p>																																	
193	HIGH TEMPERATURE (S7) STRIKE 3 COMPRESSOR 1	<p>The unit controller will disable compressor operation (lockout). Check switch, charge, fans, and coil. Default is three occurrences. Alarm will be automatically cleared after removal of cooling demand.</p>																																	
194	CRITICAL LOSS CONDENSER AIR-FLOW	<p>Critical Loss of Condenser Airflow</p>																																	

Table 76. CORE Control System Alarm and Event Codes

SELECTED ALARMS MARKED WITH * IN TABLE RESULT IN THE CLOSURE OF THE SERVICE RELAY CONTACTS (DO1).		
ALARM CODE	DISPLAY MESSAGE	EVENT ACTION
195	CRITICAL LOSS OF CHARGE COMPRESSOR 1	Critical Loss of Charge Compressor 1. In Model L this is determined by temperature readings from sensors on the coils.
196	CRITICAL LOSS OF CHARGE COMPRESSOR 2	Critical Loss of Charge Compressor 2. In Model L this is determined by temperature readings from sensors on the coils.
197	CRITICAL LOSS OF CHARGE COMPRESSOR 3	Critical Loss of Charge Compressor 3. In Model L this is determined by temperature readings from sensors on the coils.
198	CRITICAL LOSS OF CHARGE COMPRESSOR 4	Critical Loss of Charge Compressor 4. In Model L this is determined by temperature readings from sensors on the coils.
199	CRITICAL LOSS OF EVAPORATOR AIRFLOW	Critical Loss of Evaporator Airflow.
200	COMPRESSOR 1 NOT OPERATING	Compressor 1 apparently not operating. Coil temperatures not changing as expected.
201	COMPRESSOR 2 NOT OPERATING	Compressor 2 apparently not operating. Coil temperatures not changing as expected.
202	COMPRESSOR 3 NOT OPERATING	Compressor 3 apparently not operating. Coil temperatures not changing as expected.
203	COMPRESSOR 4 NOT OPERATING	Compressor 4 apparently not operating. Coil temperatures not changing as expected.
204	COMPRESSOR 1 TXV FAILED CLOSED	Compressor 1 TXV Failed Closed.
205	COMPRESSOR 2 TXV FAILED CLOSED	Compressor 2 TXV Failed Closed.
206	COMPRESSOR 3 TXV FAILED CLOSED	Compressor 3 TXV Failed Closed.
207	COMPRESSOR 4 TXV FAILED CLOSED	Compressor 4 TXV Failed Closed.
208	Major Loss of Charge Compressor 1	Major Loss of Charge Compressor 1
209	Major Loss of Charge Compressor 2	Major Loss of Charge Compressor 2
210	Major Loss of Charge Compressor 3	Major Loss of Charge Compressor 3
211	Major Loss of Charge Compressor 4	Major Loss of Charge Compressor 4
212	Major Loss of Condensor Airflow	Major Loss of Condensor Airflow
213	Major Loss of Evaporator Airflow	Major Loss of Evaporator Airflow
214	Compressor Flooding Compressor 1	Compressor Flooding Compressor 1
215	Compressor Flooding Compressor 2	Compressor Flooding Compressor 2
216	Compressor Flooding Compressor 3	Compressor Flooding Compressor 3
217	Compressor Flooding Compressor 4	Compressor Flooding Compressor 4
218	SLT SENSOR FAILURE COMPRESSOR 1	Saturated Liquid Temperature sensor on the condenser coil is not giving expected values for the indicated compressor circuit.
219	SLT SENSOR FAILURE COMPRESSOR 2	Alarming Values: 1 – Open Circuit: Less than or equal to -66°F (res >= 930kohms). 2 – Short Circuit: Greater than or equal to 500°F (res <= 24ohms).
220	SLT SENSOR FAILURE COMPRESSOR 3	3 – Out of Range: Less than -40°F or greater than 150°F. 4 – Dislodged (operational check)
221	SLT SENSOR FAILURE COMPRESSOR 4	If alarm indicates “open”, “short” or “out of range” check sensor and wiring. Alarm clears when in-range condition is detected. If alarm indicates “dislodged”, check that the sensor is installed properly and is seated properly to the fitting and is not loose or improperly installed. Alarm clears on a controller reset.

Table 76. CORE Control System Alarm and Event Codes

SELECTED ALARMS MARKED WITH * IN TABLE RESULT IN THE CLOSURE OF THE SERVICE RELAY CONTACTS (DO1).		
ALARM CODE	DISPLAY MESSAGE	EVENT ACTION
222	LT SENSOR FAILURE COMPRESSOR 1	<p>NOTE: <i>LT Sensors related alarms are only available/fitted for Ultra High Efficiency Models (Model L).</i></p> <p>Liquid Temperature sensor on the condenser coil is not giving expected values for the indicated compressor circuit.</p> <p>Alarming Values:</p> <p>1 – Open Circuit: Less than or equal to -66°F (res >= 930kohms).</p> <p>2 – Short Circuit: Greater than or equal to 500°F (res <= 24ohms).</p> <p>3 – Out of Range: Less than -40°F or greater than 150°F.</p> <p>4 – Dislodged (operational check)</p> <p>If alarm indicates “open”, “short” or “out of range” check sensor and wiring.</p> <p>Alarm clears when in-range condition is detected.</p> <p>If alarm indicates “dislodged” check that the sensor is installed properly and is seated properly to the fitting and is not loose or improperly installed.</p> <p>Alarm clears on a controller reset.</p>
223	LT SENSOR FAILURE COMPRESSOR 2	
224	LT SENSOR FAILURE COMPRESSOR 3	
225	LT SENSOR FAILURE COMPRESSOR 4	
226	SST SENSOR FAILURE COMPRESSOR 1	<p>Saturated Suction Temperature sensor on the evaporator coil is not giving expected values for the indicated compressor circuit.</p> <p>Alarming Values:</p> <p>1 – Open Circuit: Less than or equal to -66°F (res >= 930kohms)</p> <p>2 – Short Circuit: Greater than or equal to 500°F (res <= 24ohms)</p> <p>3 – Out of Range: Less than -40°F or greater than 150°F</p> <p>4 – Dislodged (operational check)</p> <p>If alarm indicates “open”, “short” or “out of range” check sensor and wiring.</p> <p>Alarm clears when in-range condition is detected.</p> <p>If alarm indicates “dislodged” check that the sensor is installed properly and is seated properly to the fitting and is not loose or improperly installed.</p> <p>Alarm clears on a controller reset.</p>
227	SST SENSOR FAILURE COMPRESSOR 2	
228	SST SENSOR FAILURE COMPRESSOR 3	
229	SST SENSOR FAILURE COMPRESSOR 4	
230	ST SENSOR FAILURE COMPRESSOR 1	<p>NOTE: <i>ST Sensors related alarms are only available/fitted for Ultra High Efficiency Models (Model L).</i></p> <p>Suction Temperature sensor on the evaporator coil is not giving expected values for the indicated compressor circuit.</p> <p>Alarming Values:</p> <p>1 – Open Circuit: Less than or equal to -66°F (res >= 930kohms)</p> <p>2 – Short Circuit: Greater than or equal to 500°F (res <= 24ohms)</p> <p>3 – Out of Range: Less than -40°F or greater than 150°F</p> <p>4 – Dislodged (operational check)</p> <p>If alarm indicates “open”, “short” or “out of range” check sensor and wiring.</p> <p>Alarm clears when in-range condition is detected.</p> <p>If alarm indicates “dislodged” check that the sensor is installed properly and is seated properly to the fitting and is not loose or improperly installed.</p> <p>Alarm clears on a controller reset.</p>
231	ST SENSOR FAILURE COMPRESSOR 2	
232	ST SENSOR FAILURE COMPRESSOR 3	
233	ST SENSOR FAILURE COMPRESSOR 4	
234	DSI BOARD 1 ERROR	Direct Spark Ignition Board 1 Error. Restart DSI Board 1 and troubleshoot wiring. Replacement may be required.
235	DSI BOARD 2 ERROR	Direct Spark Ignition Board 2 Error. Restart DSI Board 2 and troubleshoot wiring. Replacement may be required.

Table 76. CORE Control System Alarm and Event Codes

SELECTED ALARMS MARKED WITH * IN TABLE RESULT IN THE CLOSURE OF THE SERVICE RELAY CONTACTS (DO1).		
ALARM CODE	DISPLAY MESSAGE	EVENT ACTION
236	DSI BOARD 1 FLAME LOSS	Direct Spark Ignition Board 1 flame loss maximum reached. Board will be locked out for 1 hour. Check gas valve, ignition, and wiring. Lockout may be manually reset by removing power from the control for more than 1 second or removing the thermostat call for heat for more than 1 and less than 20 seconds.
237	DSI BOARD 2 FLAME LOSS	Direct Spark Ignition Board 2 flame loss maximum reached. Board will be locked out for 1 hour. Check gas valve, ignition, and wiring. Lockout may be manually reset by removing power from the control for more than 1 second or removing the thermostat call for heat for more than 1 and less than 20 seconds.
238	UTEC 1 MODBUS FAULT	Direct Spark Ignition Board 1 Modbus Loss Error. Restart DSI Board 1 and troubleshoot wiring. Replacement may be required.
239	UTEC 2 MODBUS FAULT	Direct Spark Ignition Board 2 Modbus Loss Error. Restart DSI Board 2 and troubleshoot wiring. Replacement may be required.
240	DSI BOARD 1 VALVE FAULT	Direct Spark Ignition Board 1 loss of gas valve feedback detected. CORE unit controller will lockout gas valve 1 operation. Check gas valve and wiring.
241	DSI BOARD 2 VALVE FAULT	Direct Spark Ignition Board 2 loss of gas valve feedback detected. CORE unit controller will lockout gas valve 2 operation. Check gas valve and wiring.
242	DSI BOARD 1 LOCKOUT	Direct Spark Ignition Board 1 valve fault detected and is locked out. Multiple failures has occurred. Resolve ignition issues and restart unit. CORE unit controller will lock out gas valve 1 operation.
243	DSI BOARD 2 LOCKOUT	Direct Spark Ignition Board 2 valve fault detected and is locked out. Multiple failures has occurred. Resolve ignition issues and restart unit. CORE unit controller will lock out gas valve 2 operation.
244	BLOWER DIFFERENTIAL PRESSURE SENSOR ERROR	A and B Box units equipped with 'E' type DirectPlus blowers. - Blower differential pressure sensor error; replace sensor.
245	BIPOLAR IONIZER FAULT	A Bipolar Ionizer fault is detected (J387-2 High). Alarm will clear automatically upon resolution of the problem (J387-2 Low). Check Bipolar Ionizer (Control: J392-1,3; Monitor: J387-2,7), replace if necessary.
246 - 255	RESERVED	
256	MCU/MPU COMMS LOSS	Loss of communication between M4 and W4 boards
257	A2L RDS SENSOR1 FAULT	Check leak or connection for A2L sensor1
258	A2L RDS SENSOR2 FAULT	Check leak or connection for A2L sensor2
259	A2L RDS SENSOR3 FAULT	Check leak or connection for A2L sensor3
260	DISCHARGE TEMP SENSOR FAULT - COMPRESSOR 1	The compressor 1 discharge temperature sensor has failed and is reporting an out-of-range, open circuit, or short circuit condition. This alarm indicates the sensor is not providing valid temperature readings, which may affect compressor protection functions. Inspect the sensor wiring and connections, verify the sensor resistance values, and replace the sensor if defective.
261	DISCHARGE TEMP SENSOR FAULT - COMPRESSOR 2	The compressor 2 discharge temperature sensor has failed and is reporting an out-of-range, open circuit, or short circuit condition. This alarm indicates the sensor is not providing valid temperature readings, which may affect compressor protection functions. Inspect the sensor wiring and connections, verify the sensor resistance values, and replace the sensor if defective.
264	LIQUID PRESSURE SENSOR FAULT - COMPRESSOR 1	The compressor 1 liquid pressure sensor has failed and is reporting an out-of-range, open circuit, or short circuit condition. This alarm indicates the sensor is not providing valid pressure readings, which may affect system operation and control functions. Inspect the sensor wiring and connections, verify the sensor is functioning properly, and replace the sensor if defective.
265	LIQUID PRESSURE SENSOR FAULT - COMPRESSOR 2	The compressor 2 liquid pressure sensor has failed and is reporting an out-of-range, open circuit, or short circuit condition. This alarm indicates the sensor is not providing valid pressure readings, which may affect system operation and control functions. Inspect the sensor wiring and connections, verify the sensor is functioning properly, and replace the sensor if defective.
266	SUCTION PRESSURE SENSOR FAULT - COMPRESSOR 1	The compressor 1 suction pressure sensor has failed and is reporting an out-of-range, open circuit, or short circuit condition. This alarm indicates the sensor is not providing valid pressure readings, which may affect system operation and compressor protection functions. Inspect the sensor wiring and connections, verify the sensor is functioning properly, and replace the sensor if defective.
267	SUCTION PRESSURE SENSOR FAULT - COMPRESSOR 2	The compressor 2 suction pressure sensor has failed and is reporting an out-of-range, open circuit, or short circuit condition. This alarm indicates the sensor is not providing valid pressure readings, which may affect system operation and compressor protection functions. Inspect the sensor wiring and connections, verify the sensor is functioning properly, and replace the sensor if defective.

Table 76. CORE Control System Alarm and Event Codes

SELECTED ALARMS MARKED WITH * IN TABLE RESULT IN THE CLOSURE OF THE SERVICE RELAY CONTACTS (DO1).		
ALARM CODE	DISPLAY MESSAGE	EVENT ACTION
268	DISCHARGE PRESSURE SENSOR FAULT - COMPRESSOR 1	The compressor 1 discharge pressure sensor has failed and is reporting an out-of-range, open circuit, or short circuit condition. This alarm indicates the sensor is not providing valid pressure readings, which may affect system operation and compressor protection functions. Inspect the sensor wiring and connections, verify the sensor is functioning properly, and replace the sensor if defective.
269	DISCHARGE PRESSURE SENSOR FAULT - COMPRESSOR 2	The compressor 2 discharge pressure sensor has failed and is reporting an out-of-range, open circuit, or short circuit condition. This alarm indicates the sensor is not providing valid pressure readings, which may affect system operation and compressor protection functions. Inspect the sensor wiring and connections, verify the sensor is functioning properly, and replace the sensor if defective.
270 - 512	RESERVED	
513	ERROR READING USB DEVICE	Error Reading USB Device
514	USB DEVICE NOT MOUNTED	USB Device not Mounted
515	USB DEVICE FULL	USB Device Full
516	INVALID DIN NUMBER	Invalid DIN number received from CORE unit controller, indicates DIN incompatibility
517 - 519	RESERVED	
520	FWM SOFTWARE MISMATCH	Firmware Update Failed: Software Mismatch between CORE unit controller and W4 Communication Module.
521 - 528	RESERVED	

27. CORE Control System - Parameters

Table 77. CORE Control System Unit Parameters						
Control Parameter No	Parameter Title	Control Value			Units	Description
		Min.	Default	Max.		
Power and Damper Parameters						
1 - 4	RESERVED					
5	Variable Air Volume Control Mode	0	If applicable to specific unit, see unit Parameter label for default setting.	511	Option	<ul style="list-style-type: none"> 16 = Runs the blower in high speed when occupied and there is not other active demand (room sensor mode only) 32 = Runs the blower in high speed when G is active and there is no other active demand (thermostat mode only)
6	Blower Smoke Output	20	Check unit label as Parameters may be configured to order.	100	%	<ul style="list-style-type: none"> Blower staged percentage output during smoke detection.
7	Blower Heat Output	20	Depends on equipment.	100	%	<ul style="list-style-type: none"> Blower staged percentage output high speed; used for high heating speed.
8	Blower Cool Output	20	Depends on equipment.	100	%	<ul style="list-style-type: none"> Blower staged percentage output low speed; used for low cooling or ventilation.
9	Minimum Damper Position During High Speed Blower Operation	0	0	100	%	<ul style="list-style-type: none"> Minimum damper position during low speed blower operation. Use Parameter 132 during high speed blower operation
10	Free Cooling Blower Stage Up Delay	0	300	1800	Sec	<ul style="list-style-type: none"> Free cooling blower stage-up delay. Blower runs low speed during delay, and then shifts to high speed.
11	Enabled Field Status Report		Default 0 = OFF 1 = ON		Option	Enabled Field Status Report
12	Multi-Stage Air Volume Smoke Detection Mode (Alarm)	450	Default may be altered at factory test.	24000	CFM	Multi-Stage Air Volume Smoke Detection Mode (Alarm) NOTE: In order for the SMOKE CFM change to take effect, go the SETUP > TEST & BALANCE > BLOWER and run the wizard. Performing this task will recalculate the output to the desired CFM. No adjustments are required during this procedure.
13	RESERVED					
14	Multi-Stage Air Volume Cooling Hi CFM	450	5200	24000	COUNT	Increments of 25.
15	Multi-Stage Air Volume Cooling Medium CFM	450	3375	24000	COUNT	Increments of 25.
16	Multi-Stage Air Volume Cooling Medium Low CFM	450	3375	24000	COUNT	Increments of 25.
17	Multi-Stage Air Volume Cooling Low CFM	450	3375	24000	COUNT	Increments of 25.
18	RESERVED					
19	Maximum Cubic Feet Per Minute Revolutions Per Minute	355	Default may be altered at factory test.	3300	RPM	Blower revolutions per minute
20	Multi-Stage Air Volume Blower Smoke Output	33	51	100	%	Multi-Stage Air Volume Blower staged percentage output during smoke detection for EBM MSAV Blowers.
21 - 26	RESERVED					
27	Minimum Output Cooling Vent Smoke Detection Mode (Alarm)	25	50	100	%	Minimum Output Cooling Vent Smoke Detection Mode (Alarm)
28	Minimum Output Heat	30	50	100	%	Minimum Output Heat

Table 77. CORE Control System Unit Parameters

Control Parameter No	Parameter Title	Control Value			Units	Description
		Min.	Default	Max.		
29	Minimum Damper Blower	0	Default may be altered at factory test.	101	%	Setting this Parameter to 101.0% will disable this feature.
30	Power Exhaust Stage 2 Minimum Blower	30	70	100	%	Power Exhaust Stage 2 Minimum Blower
31	Supply Proportional Base Control Loop for Variable Air Volume or Constant Air Volume with Bypass Damper	0	17	127	Counts	Variable Air Volume or Constant Air Volume with Bypass Damper supply PID Proportional constant.
32	Supply Integral Base Control Loop for Variable Air Volume or Constant Air Volume with Bypass Damper	0	12	127	Counts	Variable Air Volume or Constant Air Volume with Bypass Damper supply PID Integral constant.
33	Supply Derivative Base Control Loop for Variable Air Volume or Constant Air Volume with Bypass Damper	0	0	127	Counts	Variable Air Volume or Constant Air Volume with Bypass Damper supply PID derivative constant.
34	Constant Air Volume with Bypass Damper Static Pressure Setpoint During Smoke Alarm	0	1	5	in. w.c.	Constant air volume with bypass damper static pressure setpoint during smoke alarm.
35	Constant Air Volume with Bypass Damper Static Pressure Setpoint for Ventilation	0	1	5	in. w.c.	Constant air volume with bypass damper static pressure setpoint for ventilation.
36	Constant Air Volume with Bypass Damper Static Pressure Setpoint for Heating	0	1	5	in. w.c.	Constant air volume with bypass damper static pressure setpoint for heating.
37	Constant Air Volume with Bypass Damper Static Pressure Setpoint for Cooling	0	1	5	in. w.c.	Constant air volume with bypass damper static pressure setpoint for cooling.
38	Constant Air Volume with Bypass Damper Minimum Output Percentage Setpoint for Cooling, Ventilation and Smoke Alarms	20	20	100	%	<ul style="list-style-type: none"> Constant air volume with bypass damper minimum output for cooling, ventilation, and during smoke alarms. This sets the minimum air delivered. Bypass damper motor is set to 10 to 2 volts with 10 volts being closed. 20% setting = 2 volts or damper completely opened.
39	Constant Air Volume with Bypass Damper Minimum Output Percentage Setpoint for Heating	20	20	100	%	<ul style="list-style-type: none"> Constant air volume with bypass damper minimum output for heating. This sets the minimum air delivered. Bypass damper motor is set to 10 to 2 volts with 10 volts being closed. 20% setting = 2 volts or damper completely opened.
40	Constant Air Volume with Bypass Damper Maximum Output Percentage Setpoint	40	100	100	%	<ul style="list-style-type: none"> Constant air volume with bypass damper maximum output. This sets the maximum air delivered. Bypass damper motor is set to 10 to 2 volts with 10 volts being closed. 100% setting = 10 volts or damper completely closed.
41	Constant Air Volume with Bypass Damper Manual Reset Value Output Percentage Setpoint	20	52	100	%	Constant air volume with bypass damper manual reset value output. This is the output when unit is off.

Table 77. CORE Control System Unit Parameters

Control Parameter No	Parameter Title	Control Value			Units	Description
		Min.	Default	Max.		
42	Air Supply Static Shut-down Setpoint	0	2	5	in. w.c.	Supply static shutdown setpoint. Unit will shut down for Parameter 110 minutes if duct pressure exceeds this value for 20 seconds.
43	Static Pressure Lockout Counter Setpoint	1	3	7	Counts	The number of occurrences before permanent lockout. Counter resets when unit controller resets.
44	Supply Static Sensor (A30) Low Alarm Percentage Setpoint	30	40	100	%	<ul style="list-style-type: none"> Supply Static Pressure Sensor (A30) connected at (A133_P195_6) (TB18_6) alarm threshold. Blower percent speed before checking sensor after a 20 second delay. A value of 30% disables the low threshold or "open" alarm trap.
Electric Heating Parameters						
45	Heat Pump Maximum Defrost Cycle Time	600	840	1800	Seconds	Maximum defrost cycle duration.
46	Heat Pump Minimum Defrost Interval Time	900	1800	3600	Seconds	Minimum time between consecutive defrost cycles.
47	Heat Pump Defrost Low Outdoor Coil Temperature	20	35	40	°F	Defrost low outdoor coil temperature.
48	Heat Pump SLT Defrost Exit Temperature	50	50	120	°F	Outdoor coil temperature to exit defrost.
49 - 56	RESERVED					
57	Heat Pump (HT) Compressor Stop on RV State Switch	0	1	1	Switch	Stop compressor before switching reversing valve state. Default is True (1). NOTE: <i>Disabling this feature may result in a loud percussive sound upon actuation of the valve due to hammer effect of the refrigerant.</i>
58	Electric Heat Warm-up Time Delay for Economizer	0	3600	8160	Seconds	Warm-up time delay. The time that the economizer is forced closed during warm-up (first occupied + heat demand)
59	RESERVED					
60	Electric Heat Blower Off Delay Setpoint.	0	System Dependent	300	Seconds	The time the blower stays off after the heating demand is satisfied.
61	Electric Heat Maximum Primary and Secondary	1	3	15	Counts	Service output activation. Maximum Primary and Secondary Limit occurrences stored before service relay is energized. NOTE: <i>Heating stage is not locked out.</i>
62	Electric Heat Time Delay Between Heat Stages	12	12	60	Seconds	Time delay between heat stages.
63	Electric Heat Maximum Lower Stage Run Time in Room Sensor Applications	0	912	3600	Seconds	<ul style="list-style-type: none"> Stage up timer. The maximum time that lower stage runs before calling next heat stage. Used in room sensor applications. Disabled if set to 0.
64	Electric Heat Time Delay for Lower Stage Termination Following Higher Stage Termination	0	0	3600	Seconds	<ul style="list-style-type: none"> Time delay before a lower stage turns off following a higher stage termination. Used in room sensor applications.
Gas Heating Parameters						
65	Gas Time Delay for Economizer Being Closed During Warm-up	0	3600	8160	Seconds	Warm-up time delay. The time that the economizer is forced closed during warm-up (first occupied + heat demand).
66	Gas Blower On Delay After Heating Demand	8	40	60	Seconds	The time before the blower turns on after a heating demand.
67	Gas Blower Off Delay After Heating Demand Termination	80	120	300	Seconds	The time the blower stays on after the heating demand is terminated.

Table 77. CORE Control System Unit Parameters

Control Parameter No	Parameter Title	Control Value			Units	Description
		Min.	Default	Max.		
69	Gas Minimum Low Fire Time Prior to High Fire	30	100	300	Seconds	The minimum low fire time before high fire is allowed.
70	Heating Off Delay Timer	30	100	300	Seconds	Heating off delay.
71	Maximum Combustion Air Inducer Proof Switch Occurrence Setting Prior To Service Output Energized	1	3	5	Occurrences	Service relay activation. Maximum combustion air inducer proof switch occurrences stored before service output is energized.
72	Maximum Combustion Air Inducer Proof Switch Occurrences	1	3	15	Occurrences	After the initial maximum combustion air inducer proof switch closure, the system will continue to monitor the pressure switch and set alarm if three open occurrences are detected.
73	Maximum Gas Valve Sense Occurrences Stored Prior to Service Output Is Energized	1	3	5	Occurrences	Service output activation. Maximum gas valve sense occurrences stored before service output is energized. NOTE: Heating stage is not locked out.
74	Gas Stage Up Timer	0	912	3600	Seconds	<ul style="list-style-type: none"> Stage-up timer. The maximum time that lower stage runs before calling next heat stage. Used in room sensor applications. Disabled if set to 0.
75	Gas Stage Down Timer	0	0	3600	Seconds	<ul style="list-style-type: none"> Time delay before a lower stage turns off following a higher stage termination. Used in room sensor applications.
Block 4 Cooling Parameters						
76 - 77	RESERVED					
78	Cool Down Time Delay	0	8160	8160	Seconds	<ul style="list-style-type: none"> Cool down time delay. Time that Y2 is ignored during cool down period (when first occupied + cool demand) This delay is only used if an economizer is used and the outdoor air is suitable.
79	Cooling Blower On Time Delay	0	0	60	Seconds	The time before the blower turns on after a cooling demand.
80	Cooling Blower Off Time Delay	0	60	240	Seconds	The time the blower stays on after the cooling demand is lost.
81	Maximum Freeze Thermostat Occurrence	1	3	3	Occurrences	Service output activation and compressor lockout. Maximum freeze thermostat occurrences are stored before service relay is energized and compressor is locked-out.
82	Condenser Fan Restart Time Delay	0	6	16	Seconds	Low ambient anti-windmilling condenser fan delay. The time period that the last operating fan is turned off before starting the next fan.
83	Low Ambient Outdoor Air Limit Temperature 1 Setpoint	10	40	60	°F	<ul style="list-style-type: none"> Low ambient outdoor air limit temp. 1. Parameters 83 and 84 are used to shed fans. Temperature setting must be less than or equal to Parameter 84.
84	Low Ambient Outdoor Air Limit Temperature 2 Setpoint	10	55	60	°F	<ul style="list-style-type: none"> Low ambient outdoor air limit temp. 2. Parameters 83 and 84 are used to shed fans. Temperature setting must be greater than or equal to Parameter 83.
85	Low Ambient Temperature Lockout for Compressor 1	-31	0	80	°F	<ul style="list-style-type: none"> Low ambient lockout for compressor 1. A value of (-31°F) disables low ambient lockout function. Temperature setting must be less than or equal to Parameter 86.

Table 77. CORE Control System Unit Parameters

Control Parameter No	Parameter Title	Control Value			Units	Description
		Min.	Default	Max.		
86	Low Ambient Temperature Lockout for Compressor 2	-31	0	80	°F	<ul style="list-style-type: none"> Low ambient lockout for compressor 2. A value of (-31°F) disables low ambient lockout function. Temperature setting must be greater than or equal to Parameter 85 and less than or equal to Parameter 87.
87	Low Ambient Temperature Lockout for Compressor 3	-31	0	80	°F	<ul style="list-style-type: none"> Low ambient lockout for compressor 3. A value of (-31°F) disables low ambient lockout function. Temperature setting must be greater than or equal to Parameter 86 and less than or equal to Parameter 88.
88	Low Ambient Temperature Lockout for Compressor 4	-31	0	80	°F	<ul style="list-style-type: none"> Low ambient lockout for compressor 4. A value of (-31°F) disables low ambient lockout function. Temperature setting must be greater than or equal to Parameter 87.
89	Compressor Minimum Off Delay	60	300	510	Seconds	Compressor minimum off delay.
90	RESERVED					
91	Compressor Minimum Run Time	60	240	510	Seconds	Compressor minimum run time.
92 - 93	RESERVED					
94	Compressor Staging Time	2	3	5	Seconds	Compressor staging time.
95 - 97	RESERVED					
98	Maximum High Pressure Occurrences	1	3	7	Occurrences	Maximum High Pressure occurrences that are stored before control locks off compressor stage and energizes the service output.
99	Maximum Low Pressure Occurrences	1	3	7	Occurrences	Maximum Low Pressure occurrences that are stored before control locks off compressor stage and energizes the service relay.
100	Low Pressure Switch Ignore Time	0	120	600	Seconds	Low Pressure Switch Ignore Time.
101	Maximum Stage 1 Cooling Time Before Call for Stage 2 Cooling	0	912	3600	Seconds	Stage 2 stage up timer. The maximum time that cooling stage 1 runs before calling cooling stage 2. Used in room sensor applications. Is disabled if set to 0.
102	Maximum Stage 2 Cooling Time Before Call for Stage 3 Cooling	0	912	3600	Seconds	Stage 3 stage up timer. The maximum time that cooling stage 2 runs before calling cooling stage 3. Used in room sensor applications. Is disabled if set to 0.
103	Maximum Stage 3 Cooling Time Before Call for Stage 4 Cooling	0	912	3600	Seconds	Stage 4 stage up timer. The maximum time that cooling stage 3 runs before calling cooling stage 4. Used in room sensor applications. Is disabled if set to 0.
104	Cooling Stage Down Time	0	912	3600	Seconds	Time delay before a lower stage turns off following a higher stage termination. Used in room sensor applications.
105	Dehumidification Mode	0	0 - No Humiditrol+ is installed 7 - All Others (Check Unit Parameter Label)	8	Option	Dehumidification Mode <ul style="list-style-type: none"> 0 = No reheat (Default) 4 = Relative Humidity measurement / display. No Humiditrol+ reheat. 7 = Humiditrol+ reheat. Conditions: None 8 = Humiditrol+ reheat. Conditions: Must be occupied

Table 77. CORE Control System Unit Parameters

Control Parameter No	Parameter Title	Control Value			Units	Description
		Min.	Default	Max.		
106	Dehumidification Setpoint	0	60	99	% RH	<ul style="list-style-type: none"> Percent relative humidity where supermarket or Humiditrol+ reheat demand is energized. Used of dehumid mode option 2, 3, 5, 6 or 7. Dehumidification is de-energized at setpoint – dead-band (Parameter 107)). Digital Input 4 only. Energized input signal calls for dehumidification demand. L Connection Network Relative Humidity setpoint will override this setpoint. (Such as from NCP).
107	Dehumidification Dead Band (neutral zone)	1	3	10	% RH	Used with dehumidification Parameter 105, option 2, 3, 5, 6 or 7. Dehumidification is: <ul style="list-style-type: none"> ON when relative humidity is equal to or greater than Parameter 106. OFF when Relative Humidity is less than Parameter 106 minus Parameter 107.
108	Free Cooling Low Ambient Lockout Setpoint	45	55	80	°F	When outdoor air is suitable for free cooling and an economizer is present, the compressor will not run when ambient is below this value.
109	Smoke Alarm Control	0	0	13	Option	Smoke alarm control options. <ul style="list-style-type: none"> 0 = Blower off, exhaust fan off and fresh air damper closed. 2 = Blower off, exhaust fan on and fresh air damper closed. 9 = Blower on, exhaust fan off and fresh air damper opened. 10 = Blower on, exhaust fan on and fresh air damper closed. 11 = Blower on, exhaust fan on and fresh air damper opened.
110	Error Time Off Delay	64	300	1800	Seconds	Off time delay if a “no-run” error occurs
111	Cooling Staging Option	0	2	4	Option	Cooling staging options: <ul style="list-style-type: none"> 0 = No cooling operation 1 = Wired thermostat operation. Two cooling stages and units with Economizers. <ul style="list-style-type: none"> > Y1 = Free Cooling > Y2 = Adds all mechanical stages 2 = Wired thermostat operation. Two cooling stages and Units with Economizers. <ul style="list-style-type: none"> > Y1 - Free Cooling > Y2 - Adds first stage of mechanical 3 = Wired thermostat operation. Three cooling stages. <ul style="list-style-type: none"> > Y1 only - First stage > Y2 only - Second stage > Y1+Y2 - Third stage <p>NOTE: Units with Economizers Y2 only adds first stage of mechanical, Y1+Y2 adds first and second stage of mechanical.</p> <ul style="list-style-type: none"> 4 = Discharge air control. Up to four stages.
Block 5 Miscellaneous Parameters						
112	Heating Staging Option	0	0	1	Option	Heating staging options: <ul style="list-style-type: none"> 0 = Disabled 1 = Enabled

Table 77. CORE Control System Unit Parameters

Control Parameter No	Parameter Title	Control Value			Units	Description
		Min.	Default	Max.		
113	Enable Return Air Temperature Limit	0	2	3	Option	Limit options: <ul style="list-style-type: none"> • 0 = Disabled • 1 = Cooling RAT Limit • 2 = Heating RAT Limit • 3 = Cooling and Heating RAT Limit
114	Cooling Return Air Limit	60	65	80	°F	<ul style="list-style-type: none"> • Return air limit for cooling. If the return air cooling limit is exceeded, the cooling demands are interrupted. • Parameter 113 must be set to 1 or 3 to be enabled.
115	Heating Return Air Limit	60	85	100	°F	<ul style="list-style-type: none"> • Return air limit for heating. If the return air heating limit is exceeded, the heating demands are interrupted. • Parameter 113 must be set to 2 or 3 to be enabled.
116	RESERVED					
117	Demand Control Ventilation Maximum Damper Open	0	50	100	%	Maximum allowed demand control ventilation damper open position.
118	Demand Control Ventilation Damper Start Open	0	700	2000	PPM	<ul style="list-style-type: none"> • Damper "start open" CO₂ setpoint for Demand Control Ventilation. • Level where fresh air damper begins to open.
119	Demand Control Ventilation Maximum Damper Full Open Setpoint	0	1200	2000	PPM	<ul style="list-style-type: none"> • Damper "full open" CO₂ setpoint for Demand Control Ventilation. • Level where fresh air damper is opened to maximum.
120	Demand Control Ventilation Outdoor Air Control Hi Temperature Override Full Closed	-31	105	132	°F	High outdoor air temp. where fresh air damper is closed to minimum position.
121	Demand Control Ventilation Outdoor Air Control Hi Temperature Override Start Closing	-31	75	132	°F	High outdoor air temperature where fresh air damper begins to close.
122	Demand Control Ventilation Outdoor Air Control Low Temperature Override Full Closed	-31	10	132	°F	Low outdoor air temperature where fresh air damper is closed to minimum position
123	Demand Control Ventilation Outdoor Air Control Low Temperature Override Start Closing	-31	40	132	°F	Low outdoor air temp. where fresh air damper begins to close.
124 - 125	RESERVED					
126	Outdoor Air Velocity Set Point	0	100	1960	Feet/Min	In OAC mode, the unit controller closes the damper as voltage increases to maintain a constant amount of fresh air. The sensor will read 10VDC at maximum flow and 0VDC at minimum flow.
127	Outdoor Air Manual Reset	0	50	100	%	Manual reset value.
128	Outdoor Air Control PID P Constant	0	2	127	Counts	Outdoor Air Control PID P Constant
129	Outdoor Air Control PID I Constant	0	30	127	Counts	Outdoor Air Control PID I Constant
130	Outdoor Air Control PID D Constant	0	0	127	Counts	Outdoor Air Control PID D Constant
131	Free Cooling Maximum Damper	0	100	100	%	The maximum allowed fresh air damper opening for free cooling.
132	Minimum Damper Position	0	0	100	%	Minimum fresh air damper position during occupied operation.

Table 77. CORE Control System Unit Parameters

Control Parameter No	Parameter Title	Control Value			Units	Description
		Min.	Default	Max.		
133	Room Sensor Start-up Delay	120	120	1800	Seconds	<ul style="list-style-type: none"> Suspends all unit operation room sensor and Constant Air Volume with bypass damper applications. Suspends Fresh Air Heat Control-Reheat, Fresh Air Cooling Control, Fresh Air Heat Control options and all GP outputs. May be used to stagger unit start-ups. Does NOT delay demands in thermostat mode.
134	Indoor Air Quality Input Mode	0	1	7	Option	<p>Options are:</p> <ul style="list-style-type: none"> 0 = Ventilation is disabled. 1 = Demand control ventilation with outdoor temperature limit and blower on. (Default) 2 = Demand control ventilation without Outdoor Temperature Limit and Blower ON. 3 = Demand control ventilation with Outdoor Temperature Limit and Blower AUTO / ON. 4 = Demand control ventilation without Outdoor temperature Limit and no blower AUTO / ON. 5 = Outdoor air control with outdoor temperature limit. 6 = Outdoor air control without outdoor temperature limit 7 = Building pressure control
System 1 Parameters						
135 - 136	RESERVED					
137	Occupied Heating Setpoint	40	70	95	°F	<ul style="list-style-type: none"> Backup occupied heating setpoint. Used if the communications link is lost for 5 minutes between the CORE unit controller and NCP. Used only with room sensor applications. Setpoint temperature must be less than or equal to (Parameter 139 minus Parameter 152).
138	Unoccupied Heating Setpoint	40	60	95	°F	<ul style="list-style-type: none"> Backup unoccupied heating setpoint. Used if the communications link is lost for 5 minutes between the unit controller and NCP. Used only in room sensor applications. Setpoint temperature must be less than or equal to (Parameter 140 minus Parameter 152).
139	Occupied Cooling Setpoint	40	75	95	°F	<ul style="list-style-type: none"> Backup occupied cooling setpoint. Used if the communications link is lost for 5 minutes between the unit controller and NCP. Used only in room sensor applications. Setpoint temperature must be greater than or equal to Parameter 137 plus Parameter 152).
140	Unoccupied Cooling Setpoint	40	85	95	°F	<ul style="list-style-type: none"> Backup unoccupied cooling setpoint. Used if the communications link is lost for 5 minutes between the CORE unit controller and network control panel. Used only in room sensor applications. Setpoint temperature must be greater than or equal to Parameter 138 plus Parameter 152).
141	After Hours Override Time Delay	0	3600	28800	Seconds	<ul style="list-style-type: none"> After hours override timer. Only used on room sensor applications without a network control panel.
142	Heat Stage Deadband	1	1	3.75	°F	<ul style="list-style-type: none"> Heating dead-band. Used only with CORE unit controller room sensor applications. Dead band must be less than or equal to Parameter 152 minus Parameter 143.

Table 77. CORE Control System Unit Parameters

Control Parameter No	Parameter Title	Control Value			Units	Description
		Min.	Default	Max.		
143	Cool Stage Deadband	1	1	3.75	°F	<ul style="list-style-type: none"> Cooling dead-band. Used only with room sensor applications. Dead band must be less than or equal to parameter 152 minus parameter 142.
144	Cooling Stage 1 Differential	0	0.5	3	°F	<ul style="list-style-type: none"> Cooling stage 1 differential. Used only with room sensor applications. Differential temperature must be less than or equal to parameter 145.
145	Cooling Stage 2 Differential	0	1	3	°F	<ul style="list-style-type: none"> Cooling stage 2 differential. Used only with room sensor applications. Differential temperature must be greater than or equal to parameter 144 and less than or equal to parameter 146.
146	Cooling Stage 3 Differential	0	1.5	3	°F	<ul style="list-style-type: none"> Cooling stage 3 differential. Used only with room sensor applications. Differential temperature must be greater than or equal to parameter 145 and less than or equal to parameter 147.
147	Cooling Stage 4 Differential	0	2	3	°F	<ul style="list-style-type: none"> Cooling stage 4 differential. Used only with room sensor applications. Differential temperature must be greater than or equal to parameter 146.
148	Heating Stage 1 Differential	0	0.5	3	°F	<ul style="list-style-type: none"> Heating stage 1 differential. Used only with room sensor applications. Differential temperature must be less than or equal to Parameter 149.
149	Heating Stage 2 Differential	0	1	3	°F	<ul style="list-style-type: none"> Heating stage 2 differential. Used only with room sensor applications. Differential temperature must be greater or equal to Parameter 148.
150	Heating Stage 3 Differential	0	1.5	3	°F	<ul style="list-style-type: none"> Heating stage 3 differential temperature. Used only with room sensor applications. Differential temperature must be greater than or equal to Parameter 149.
151	Heating Stage 4 Differential	0	2	3	°F	<ul style="list-style-type: none"> Heating stage 4 differential temperature. Used only with room sensor applications. Differential temperature must greater than or equal to Parameter 150.
152	Automatic Changeover Deadband	2	3	10	°F	<ul style="list-style-type: none"> Minimum auto changeover dead-band temperature. Dead band must be greater than or equal to Parameter 142 plus Parameter 143. Used in room sensor applications.
153	Automatic Changeover Delay	60	300	900	Seconds	Auto changeover time delay. Delay between heating and cooling modes.
154	Occupied Blower Mode	0	0	3	Option	<p>Blower control option for room sensor applications during occupied periods.</p> <ul style="list-style-type: none"> 0 = Auto Cycle: Blower cycles with demand. 1 = On-Continuous 1: Blower is on with either the occupancy sensor or occupancy schedule indicating occupied. 2 = On-Continuous 2: Blower is on only when both the occupancy sensor and occupancy scheduler indicates occupied. 3 = On-Continuous 3: Blower is on only when both the occupancy sensor and occupancy scheduler indicates occupied. In addition, blower will be on a minimum of 25% of the time when occupancy scheduler indicates occupied. The 25% minimum is achieved by turning blower on for 30 minutes and off for 90 minutes.

Table 77. CORE Control System Unit Parameters

Control Parameter No	Parameter Title	Control Value			Units	Description
		Min.	Default	Max.		
155	Free Cooling Lockout Setpoint	29	29	60	°F	<ul style="list-style-type: none"> Locks out free cooling when outdoor temperature is below the set value. Setting value to 29°F disables free cooling lockout.
156	Fresh Air Heating Setpoint	40	40	70	°F	Fresh air heating setpoint
157	Fresh Air Heating Stage Deadband	3	10	15	°F	Fresh Air Heating stage dead-band.
158	Fresh Air Heating Minimum Cycle Time	120	480	1800	Seconds	Fresh Air heating minimum cycle time.
159	Free Cooling Supply Setpoint	45	55	65	°F	Economizer modulates dampers to maintain supply air temperature (RT6) at this setpoint during free cooling. DACC reset applies. See Parameter 207 - Parameter 201.
160	Economizer Free Cooling Temperature Setpoint	40	60	75	°F	Outdoor Air Temperature is less than Parameter Setpoint between 41-75°F or when Outdoor Air temperature is less than Return Air Temperature between 0-40°F.
161	Economizer Free Cooling Temperature Offset	0	10	40	°F	Economizer Free Cooling Temperature Offset
162	Economizer Free Cooling Enthalpy Setpoint	10	12	19	mA	Economizer Free Cooling Enthalpy Setpoint
163	Economizer Free Cooling Enthalpy Offset	0.2	1	5	mA	Economizer Free Cooling Enthalpy Offset
164	Economizer Profile	0	1	3	Option	<p>These are the operating profile options for the economizer damper during free cooling when any compressor is on and can be selected as follows:</p> <ul style="list-style-type: none"> Option 0: Damper continues to modulate while compressors are on, but the effect of mechanical cooling may force the damper closed to its minimum position. After compressor starts, the free cooling setpoint is lowered to a fixed temperature of 45°F. Option 1: Damper opens to its max open position (Parameter 131 - FREE CL MAX DAMPER) when any compressors start. <p>NOTE: When using Option 1 and after the compressor is stopped, the CORE unit controller will resume damper modulation.</p> <ul style="list-style-type: none"> Option 2: Damper continues to modulate while compressors are on, but the effect of mechanical cooling may force the damper closed to its minimum position. This is the factory default setting. <ul style="list-style-type: none"> > Holds off compressor on Y2 call until damper has modulated to maximum position (Parameter 131 - FREE CL MAX DAMPER) for three minutes. > After three minutes, compressor starts and the free cooling setpoint is lowered to 45°F. Damper is not locked at maximum open while compressor is on, but modulates to maintain 45°F discharge air temperature. > When Y2 is satisfied, compressor goes off and free cooling setpoint is restored to 55°F (Parameter 159 - FREE COOL SUPPLY SP). Option 3: Same as Option 2, but with a 10-minute delay instead of a three-minute delay.

Table 77. CORE Control System Unit Parameters

Control Parameter No	Parameter Title	Control Value			Units	Description
		Min.	Default	Max.		
System 2 Parameters						
165	Fresh Air Heating Stage Differential	0	2	20	°F	<ul style="list-style-type: none"> Fresh Air Heating stage differential. 0 value for first stage heating only for Fresh Air Heating.
166	Fresh Air Heating Control Reheat Outdoor Air Temperature Setpoint	20	45	60	°F	Outdoor air temperature setpoint that enables fresh air heating for reheat demand and opens damper to parameter 167 when outdoor air is less than setpoint.
167	Fresh Air Heating Control Reheat Damper Position	5	40	100	%	Fresh air damper position during Fresh Air Heating reheat operation.
168	Fresh Air Heat Control Setpoint	40	40	70	°F	Fresh Air Heating Reheat setpoint.
169	Fresh Air Tempering Automatic Changeover Delay	900	1800	7200	Seconds	Fresh Air Heating Control or Fresh Air Cooling Control air Tempering auto-changeover delay.
170	Fresh Air Cooling Setpoint	60	90	90	°F	Fresh air cooling setpoint.
171	Fresh Air Cooling Control Deadband	3	10	15	°F	Fresh Air Cooling stage dead-band.
172	Fresh Air Cooling Control Cycle Time	120	480	1800	Seconds	Fresh Air Cooling minimum cycle time.
173	Fresh Air Cooling Control Stage Differential	0	2	20	°F	<ul style="list-style-type: none"> Fresh Air Cooling stage differential between stages. Set to 0 for first stage cooling only for Fresh Air Cooling.
174	Discharge Air Control Heating Occupied Setpoint	60	110	140	°F	Discharge Air Control Heating setpoint during occupied period.
175	Discharge Air Control Heating Unoccupied Setpoint	60	95	140	°F	Discharge Air Control Heating setpoint during unoccupied period.
176	Discharge Air Control Heating Stage Deadband	5	5	20	°F	Discharge Air Control Heating dead-band.
177	Discharge Air Control Heating Stage-Up Time Delay	0	180	900	Seconds	Discharge Air Control Heating and Fresh Air Heating stage-up time delay.
178	Discharge Air Control Heating and Fresh Air Heating Control Stage-Down Time Delay	0	120	600	Seconds	Discharge Air Control Heating and Fresh Air Heating stage-down time delay.
179	Discharge Air Control Heating Stage Differential	2	2	20	°F	Discharge Air Control Heating stage differential.
180	Discharge Air Control Cooling Occupied Setpoint	40	55	80	°F	Discharge Air Control Cooling setpoint during occupied period.
181	Discharge Air Control Cooling Unoccupied Setpoint	40	65	100	°F	Discharge Air Control Cooling setpoint during unoccupied period.
182	Discharge Air Control Cooling Deadband Setpoint	5	5	20	°F	Discharge Air Control Cooling stage dead-band.
183	Discharge Air Control Cooling and Fresh Air Cooling Stage-Up Delay	0	180	900	Seconds	Discharge Air Control Cooling and Fresh Air Cooling stage-up delay.
184	Discharge Air Control Cooling and Fresh Air Cooling Stage-Down Time Delay	0	120	600	Seconds	Discharge Air Control Cooling and Fresh Air Cooling stage-down time delay.
185	Discharge Air Cooling Stage Differential	2	2	20	°F	Discharge Air Cooling stage differential.

Table 77. CORE Control System Unit Parameters

Control Parameter No	Parameter Title	Control Value			Units	Description
		Min.	Default	Max.		
186	Service Output Control Mode	0	0	127	Option	<p>A55 Service Output Control Mode = $X + 32*Y + 16*Z$</p> <p>Input source = X:</p> <ul style="list-style-type: none"> • 0 = None • 1 = Compressor 1 duty cycle. (Compressor crankcase heater function.) <ul style="list-style-type: none"> > On when outdoor air temperature is less than or equal to Parameter 189 and greater than or equal to Parameter 192 seconds have passed with compressor 1 off. > Off when Outdoor Air temperature is greater than Parameter 189 plus 3°F (fixed dead-band) or is less than Parameter 192 seconds have passed with compressor 1 off. • 2 = On when occupied • 3 = On when blower on • 4 = On when heating demand • 5 = On when cooling demand • 6 = On when heating or cooling demand • 7 = System Relative Humidity (A55_P298_5 RH) • 8 = System Indoor Air Quality (A55_P298_3 IAQ) • 9 = System Outdoor Air Temperature (A55_P267_1/2 OAT) • 10 = Energy Recovery System • 11 = SCR Option for Electric Heat <p>Algorithm Y for input sources 7 - 9:</p> <ul style="list-style-type: none"> • 0 = Hysteresis loop (see sections 14.2 - 14.4) • 1 = Window - On when input is in range (see sections 14.2 - 14.4) • 2 = Delayed-on (see sections 14.2 - 14.4) • 3 = Delayed-off (see sections 14.2 - 14.4) <p>Inversion Z:</p> <ul style="list-style-type: none"> • 0- Output not inverted • 1- Output inverted
187	Service Output Setpoint for Carbon Dioxide	0	996	2000	ppm	A55 service relay output setpoint
188	Service Output Setpoint for Relative Humidity	0	100	100	%	Service Output Setpoint for Relative Humidity
189	Service Output Setpoint Temperature	-31	51	132	°F	Service Output Setpoint Temperature
190	Service Output Dead-band for Carbon Dioxide	16	102	2000	ppm	A55 service relay output dead-band or delay
191	Service Output Dead-band for Relative Humidity	2	13	100	%	Service Output Deadband for Relative Humidity
192	Service Output Dead-band for Temperature	1	8	162	°F	Service Output Deadband for Temperature
193	Service Output Delay	64	416	8160	Seconds	Service Output Delay

Table 77. CORE Control System Unit Parameters

Control Parameter No	Parameter Title	Control Value			Units	Description
		Min.	Default	Max.		
194	Number of compressors to shed during load shedding	0	0	4	Option	<p>Number of compressors to be turned off when load shedding is active.</p> <p>For models with two-stage compressors, each stage is treated as a separate compressor for the purpose of load shedding.</p> <p>For example, on an RTU with a single 2-stage compressor, a value of one shuts off 2nd stage only and a value of two turns compressor completely off.</p>
195 - 200	RESERVED					
System 3 Parameters						
201	Discharge Air Control Cooling Outdoor Air Temperature Adjustment Band	0	0	30	°F	<ul style="list-style-type: none"> Discharge Air Control Cooling outdoor temperature ambient cooling adjustment reset band. Also used to reset free cooling setpoint (Parameter 159).
202	Discharge Air Control Cooling Outdoor Air Temperature Cooling Reset Setpoint	40	80	100	°F	<ul style="list-style-type: none"> Discharge Air Control Cooling outdoor air temperature cooling reset setpoint. Also used to reset free cooling setpoint (Parameter 159).
203	Discharge Air Control Cooling Outdoor Ambient Air Temperature Cooling Proportional Band	1	20	60	°F	<ul style="list-style-type: none"> Discharge Air Control Cooling outdoor ambient temperature cooling proportional band. Also used to reset free cooling setpoint (Parameter 159).
204	Discharge Air Control Cooling Return Air Reset Adjustment Band	0	0	30	°F	<ul style="list-style-type: none"> Discharge Air Control Cooling return air reset adjustment band. 0 disables return air cooling reset. Also used to reset free cooling setpoint (Parameter 159).
205	Discharge Air Control Return Air Reset Adjustment Setpoint	50	70	80	°F	<ul style="list-style-type: none"> Discharge Air Control Cooling return air reset setpoint. Also used to reset free cooling setpoint (Parameter 159).
206	Discharge Air Control Cooling Return Air Reset Proportional Band	1	10	30	°F	<ul style="list-style-type: none"> Discharge Air Control Cooling return air reset proportional band. Also used to reset free cooling setpoint (Parameter 159).
207	Discharge Air Control Cooling Reset Limit	5	10	20	°F	<ul style="list-style-type: none"> Discharge Air Control Cooling total reset limit. This limits the total DACC reset allowed. Also used to reset free cooling setpoint (Parameter 159).
208	Discharge Air Control Heating Outdoor Air Temperature Reset Adjustment Band	0	0	30	°F	Discharge Air Control Heating outdoor temperature reset adjustment band.
209	Discharge Air Control Heating Reset Adjustment Setpoint	-31	40	60	°F	Discharge Air Control Heating outdoor temperature reset setpoint.
210	Discharge Air Control Heating Outdoor Air Temperature Reset Proportional Band	1	20	60	°F	Discharge Air Control Heating temperature reset proportional band.
211	Discharge Air Control Heating Return Air Temperature Adjustment Band	0	0	30	°F	Discharge Air Control Heating return reset adjustment band.
212	Discharge Air Control heating Return Air Heating Reset Setpoint	50	70	80	°F	Discharge Air Control Heating return air heating reset setpoint.

Table 77. CORE Control System Unit Parameters

Control Parameter No	Parameter Title	Control Value			Units	Description
		Min.	Default	Max.		
213	Discharge Air Control Heating Return Air Heating Reset Proportional Band	1	10	30	°F	Discharge Air Control Heating return air heating reset proportional band.
214	Discharge Air Control Heating Return Air Heating Reset Limit	5	10	20	°F	Discharge Air Control Heating reset limit. This limits the total DACH reset allowed.
215	Exhaust Fan Stage 1 Damper Setpoint	0	50	100	%	Exhaust fan stage 1 damper setpoint.
216	Exhaust Fan Stage 1 Damper Deadband	0	10	100	%	Exhaust Fan Stage 1 Damper Deadband.
217	Stage 1 setpoint	-0.5	0.05	0.5	in w.c.	Exhaust Fan Stage 1 Pressure Setpoint.
	or VFD PE setpoint					or VFD Power Exhaust Building Pressure Setpoint.
218	Stage 1 deadband	0	0.02	1	in w.c.	Exhaust Fan Stage 1 Pressure Deadband.
219	Exhaust Fan Stage 2 Damper Setpoint	0	75	100	%	Exhaust Fan Stage 2 Damper Setpoint.
220	Exhaust Fan Stage 2 Damper Deadband	0	10	100	%	Exhaust Fan Stage 2 Damper Deadband.
221	Stage 2 setpoint	-0.5	0.05	0.5	in w.c.	Exhaust Fan Stage 2 Pressure Setpoint.
222	Stage 2 deadband	0	0.05	1	in w.c.	Exhaust Fan Stage 2 Pressure Deadband.
223	Exhaust Fan Stage Up Delay	0	100	300	Seconds	Exhaust Fan Stage Up Delay.
224	Exhaust Fan Stage Down Delay	0	100	200	Seconds	Stage 1 off-delay (only used for 2 stage operation).
225 - 257	RESERVED					
258	Display Unit (Fahrenheit or Celsius)		FAHRENHEIT (default setting) or CELSIUS		Option	Temperature unit of measurement.
259 - 284	RESERVED					
285	Free Cooling Compressor Lockout Mode	0	2	2	Option	<ul style="list-style-type: none"> 0 = Disable Free Cooling Low Ambient Compressor Lockout (default). 1 = Lockout Compressor whenever the outdoor air is suitable regardless of outdoor air temperature. 2 = Enable Free Cooling Low Ambient Compressor Lockout.
286	RESERVED					

Table 77. CORE Control System Unit Parameters

Control Parameter No	Parameter Title	Control Value			Units	Description
		Min.	Default	Max.		
287	Algorithms Enabled	Here is an example of the selection options for Algorithms Enable via the Lennox UC Software: Set Bit Description 0x00000001 Enable Algorithm Relative Humidity Input (ALGO_RH_DIGITAL_INPUT) 0x00000002 Enable Fresh Air Heating (ALGO_FAH) 0x00000004 Enable Fresh Air Cooling (ALGO_FAC) 0x00000008 Enable DACC Return Air Reset (ALGO_DACC_RAT_RESET) 0x00000010 Enable DACC Outdoor Air Reset (ALGO_DACC_OAT_RESET) 0x00000020 Enable DACH Return Air Reset (ALGO_DACH_RAT_RESET) 0x00000040 Enable DACH Outdoor Air Reset (ALGO_DACH_OAT_RESET) 0x00000080 Enable Supply Static Pressure Sensor Alarm (ALGO_LO_STATIC_PRESSURE_ALARM) 0x00000100 Enable Low Outdoor Temp override of DCV/OAC operation (ALGO_LO_OAT_DCV_OAC_OVERRIDE) 0x00000200 Enable High Outdoor Temp override of DCV/OAC operation (ALGO_HI_OAT_DCV_OAC_OVERRIDE) 0x00000400 Undefined 0x00000800 Enable Free Cooling Blower Stage Up				
288 - 304	RESERVED					
305	LonTalk Heartbeat Time	0	100	10,000	Seconds	Heartbeat configuration proprieties define how often a network variable update is transmitted from a sending node.
306 - 312	RESERVED					
313	Fresh Air Reheat Mode	0	0	3	Option	<ul style="list-style-type: none"> 0 Disabled 1 Allowed, must be occupied 2 Allowed, blower must be energized and in occupied mode. 3 Allowed. No conditions apply.
314	MSAV Minimum VFD Drive Output	10	25	50	%	The CORE unit controller will ensure that active VFD drive output is equal or greater than Minimum VFD drive output. If conversion from CFM setting to VFD drive yields lower value. The system will use Minimum VFD drive output instead output.
315 - 316	RESERVED					
317	Outdoor Air Unit Options	0	0	2	Option	This Parameter is applicable in Zone Sensor mode (i.e. not applicable for local/remote thermostat mode). <ul style="list-style-type: none"> 0 - Outdoor Air Disabled 1 - Outdoor Air Local TSTAT on 2 - Outdoor Air Local TSTAT On N Off
318 - 320	RESERVED					
321	Enthalpy High Temperature Limit	45	75	85	°F	When in Enthalpy mode, the outdoor air suitability (OAS) will be set only if the outdoor air temperature is less than this Parameter setpoint.
322	RESERVED					
323	Zone Sensor Calibration Offset	-5	0	5	°F	This setting is applicable to local temperature sensor only.
324 - 326	RESERVED					
327	Building Pressure Control Manual Reset	0	50	100	%	Manual reset value. This Parameter defines the default outdoor air damper position.
328	Building Pressure Control PID P Constant	0	100	127	Count	BPC PID Proportional Constant
329	Building Pressure Control PID I Constant	0	30	127	Count	BPC PID Integral Constant

Table 77. CORE Control System Unit Parameters

Control Parameter No	Parameter Title	Control Value			Units	Description
		Min.	Default	Max.		
330 - 374	RESERVED					
375	Discharge Air Cooling Setpoint	45	55	65	°F	Setpoint used by the compressor / DAT PI in room sensor mode to determine the compressor speed.
376	Discharge Air Cooling Enhanced Dehumidification Setpoint.	45	50	55	°F	Discharge Air Cooling Enhanced Dehumidification Setpoint. Setpoint used by the compressor / DAT PI in room sensor mode to determine the compressor speed in Enhanced Dehumidification mode.
377 - 381	RESERVED					
382	Blower Low Heat Output	20	Depends on equipment	100	%	Blower staged percentage output low speed; used for low heating for certain P volt models
383 - 385	RESERVED					
386	VAV Supply Static Pressure Setpoint	0	1	5	in w.c.	VAV supply static pressure setpoint during smoke operation.
387	VAV Supply Static Pressure Setpoint during Ventilation	0	1	5	in w.c.	VAV supply static pressure setpoint during ventilation.
388	VAV Heat Pressure Setpoint	0	1	5	in w.c.	VAV supply static pressure setpoint during heating.
389	VAV Cooling Pressure Setpoint	0	1	5	in w.c.	VAV supply static pressure setpoint during cooling.
390	VAV Maximum Output	40	100	100	%	VAV PID loop max speed
391	VAV Manual Reset	0	60	100	%	VAV PID loop manual reset value.
392 - 400	RESERVED					
401	Power Exhaust Mode	0	0	3	Options	<ul style="list-style-type: none"> • 0 Blower • 1 Always • 2 Occupied • 3 DIN_Exhaust_Fan_Digital_Enable
402	Low Speed Cycling	0	1	1	Options	<ul style="list-style-type: none"> • 0 = Disabled • 1 = Enables Low Speed Cycling
403	Speed for Stage 1 when using a VFD for Controlling Exhaust Fan in Staged Mode.	0	50	100	%	Speed for stage 1 when using a VFD for controlling exhaust fan in staged mode.
404	Speed for Stage 2 when using a VFD for Controlling Exhaust fan in Staged Mode.	0	100	100	%	Speed for stage 2 when using a VFD for controlling exhaust fan in staged mode.
405	Exhaust Fan Setpoint for PID Control	-0.50	-0.50	0.50	in w.c.	Exhaust Fan setpoint for PID control
406	Exhaust Fan PID Loop Min Speed	0	33	100	%	Exhaust Fan PID loop min speed
407	Exhaust Fan PID Loop Max Speed	0	100	100	%	Exhaust Fan PID loop max speed
408	Exhaust Fan PID Loop Manual Reset Value	0	50	100	%	Exhaust Fan PID loop max speed
409	Exhaust Fan PID loop proportional constant	0	20	127	Counts	Exhaust Fan PID loop proportional constant
410	Exhaust Fan PID loop integral constant	0	64	127	Counts	Exhaust Fan PID loop integral constant
411	Exhaust Fan PID loop derivative constant	0	0	127	Counts	Exhaust Fan PID loop derivative constant
412 - 413	RESERVED					
414	High Cool Reheat Time Out	0	0	30	Seconds	Reheat run-time on call for high cooling.
415 - 420	RESERVED					

Table 77. CORE Control System Unit Parameters

Control Parameter No	Parameter Title	Control Value			Units	Description
		Min.	Default	Max.		
421	Local Zone Sensor Type	0	0	1	Options	Local Zone Sensor Type. 0 = 11K 1 = 10K
422 - 450	RESERVED					
451	Enhanced Dehumidification Maximum Setpoint	50	50	55	°F	<ul style="list-style-type: none"> The discharge air target used for zone temperature-based enhanced dehumidification (EDH-ZAT) operation when Zone Temperature setpoint is > 80F. To configure EDH, use the RTU MENU > SETUP > INSTALL wizard.
452	Enhanced Dehumidification Minimum Setpoint	45	45	50	°F	<ul style="list-style-type: none"> The discharge air target used for zone-temperature-based enhanced dehumidification (EDH-ZAT) operation when Zone Temperature setpoint is < 70F. To configure EDH, use the RTU MENU > SETUP > INSTALL wizard.
453 - 462	RESERVED					
463	SST Minimum Setpoint	35	40	50	°F	Minimum Saturated Suction Temperature (SST) target for the RTU coil, used in Humiditrol+ operations.
464	SST Maximum Setpoint	40	45	50	°F	Maximum Saturated Suction Temperature (SST) target for the RTU coil, used in Humiditrol+ operations.
465 - 466	RESERVED					
467	Reheat Fan DAT Target TSTAT	50	70	100	°F	Discharge Air Temperature (DAT) target for reheat (Humiditrol+) operation. Condenser fans will attempt to control exiting air temperature to this value. This is used only in TSTAT applications.
468	Reheat Blower SST Target TSTAT	30	45	60	°F	Saturated Suction Temperature (SST) target for reheat (Humiditrol+) operation. This is only used in TSTAT Applications
469 - 476	RESERVED					
477	Free Cooling High Blower Error	10	60	90	%	Free Cooling threshold for high blower PI error. Used for determining when to add or remove mechanical cooling in Room Sensor Mode.
478	RESERVED					
479	Free Cooling Low Blower Error	0	15	50	%	Free Cooling threshold for minimum blower PI error. Used for determining when to enter free cooling in Room Sensor Mode.
480 - 510	RESERVED					
511	Freezestat SST Temperature	0	32	40	°F	Saturated Suction Temperature (SST) target for freezestat operation. The unit will register a freezestat trip when the SST falls below this setpoint for Parameter 514 seconds.
512 - 513	RESERVED					
514	Freezestat SST Persistence Time	0	180	1800	Seconds	<p>Saturated Suction Temperature (SST) persistence time for freezestat operation. The unit will register a freezestat trip when the SST falls below the setpoint listed in Parameter 511 for greater than this amount of time.</p> <p><i>NOTE: Compressor staging, Blower staging, or transitions into free cooling will delay this response to allow refrigerant temperature stabilization.</i></p>

Table 77. CORE Control System Unit Parameters

Control Parameter No	Parameter Title	Control Value			Units	Description
		Min.	Default	Max.		
515	RESERVED					
516	Minimum Outdoor Fan Speed A Box	10	20	30	%	Minimum speed for ECM OD fans for all Enlight A-boxes.
517	Maximum Outdoor Fan Speed A Box	70	83	100	%	Maximum speed for ECM OD fans for all Enlight A-boxes.
518	Minimum Outdoor Fan Speed B Box	10	20	30	%	Minimum speed for ECM OD fans for all Enlight B-boxes.
519	Maximum Outdoor Fan Speed B Box	70	95	100	%	Maximum speed for ECM OD fans for all Enlight B-boxes.
520	Minimum Outdoor Fan Speed C Box	10	20	30	%	Minimum speed for ECM OD fans for all Enlight C-boxes.
521	Maximum Outdoor Fan Speed C Box	70	85	100	%	Maximum speed for ECM OD fans for all Enlight C-boxes.
522 - 525	RESERVED					
526	Heat Pump Dual Fuel	-10	35	65	°F	<p>This parameter controls when heat pump operation will be locked-out. If OAT is at or below this setpoint when heat demand changes, gas heating is used and mechanical heating is locked-out.</p> <p>Weigh the comfort / cost benefit when increasing the setpoint.</p>
527	Heat Pump Low Ambient Heating (LAH) Compressor Lockout Temperature Low	-50	-15	0	°F	<p>This parameter controls when heat pump operation will be locked-out. If mechanical heating is already active and OAT drops to or below this setpoint, mechanical heating will be stopped.</p> <p>When LAH lockout is in effect, electric heat will be enabled on W1 calls, if units are equipped with EH.</p> <p>For units without aux electric heat, the unit will not provide any heating when below this threshold.</p>
528	Heat Pump Low Ambient Heating (LAH) Compressor Lockout Temperature High	-50	-4	0	°F	<p>This parameter controls when heat pump operation will be locked-out. If mechanical heating is not active when heat demand changes and OAT is at or below this setpoint, mechanical heating will not be started.</p> <p>When LAH lockout is in effect, electric heat will be enabled on W1 calls, if units are equipped with EH.</p> <p>For units without aux electric heat, the unit will not provide any heating when below this threshold.</p>
529 - 530	RESERVED					
531	Blower On Delay After Mechanical Heating Demand	0	0	60	Seconds	The time before the blower turns on after a heating demand.
532	Blower Off Delay After Mechanical Heating Demand Termination	0	20	300	Seconds	The time the blower stays on after the heating demand is terminated.
533	Heat Pump Heat Warm-up Time Delay for Economizer	0	3600	8160	Seconds	Warm-up time delay. The time that the economizer is forced closed during warm-up (first occupied + heat demand). This applies to LH and LD units, regardless of the secondary heat source.
534	Heat Pump Heat Maximum Lower Stage Run Time in Room Sensor Applications	0	912	3600	Seconds	Stage up timer. The maximum time that a lower stage runs before calling the next heat stage. Used in room sensor applications. Disabled if set to 0.
535	Heat Pump Heat Time Delay for Lower Stage Termination Following Higher Stage Termination	0	0	3600	Seconds	Time delay before a lower stage turns off following a higher stage termination. Used in room sensor applications.

Table 77. CORE Control System Unit Parameters

Control Parameter No	Parameter Title	Control Value			Units	Description
		Min.	Default	Max.		
536 - 540	RESERVED					
541	VAV supply static pressure set point during A2L refrigerant leak mitigation	0	1	5	in. w.c.	VAV supply static pressure setpoint during a refrigerant leak.
542	RESERVED					
543	A2L Refrigerant Detection System Configuration Flags	0	1	3	option	0, 2 - No RDS audible alarm 1 - Audible alarm on RDS leak detection only (continuous) 3 - Audible alarm on RDS leak detection (continuous) OR a sensor problem (5 second duration)
544 - 548	RESERVED					
549	A2L RDS Initial Purge Duration	0	0	300	seconds	Length of time to run the blower, fans and CAB (if present) at startup as a preventive measure.
606	No Blower Defrost	0	0	1	option	Turn blower off during defrost (Strategos + HP models only)
607	Load Shed Aux Heat	0	0	1	option	Disable aux heat when load shedding compressors during heating
629	DAT Setpoint Heating	60	95	140	°F	DAT Setpoint for mechanical heating

28. CORE Firmware Update Release History

9.03.0180

- Added Strategos Heat Pump models.

9.02.0242

- Initial release.

Index

A

Abbreviations 5

Air Flow Proving Switch (S52 - Optional) 46

Alarms 125

Auto-Addressing 10

B

Blower Off-Delay 47

Blower On-Delay 46

Blower Operation (Occupied) in Room Sensor Mode 40

C

Closed Proof Alarms 45

Cloud/IP Configuration Menu Structure 22

Combustion Air Inducer (CAI) Proof Switches (S18 and S45) 45

Compressor Minimum Run-Time Off-Delay 43

Compressor Protection and Delays 43

Configuration ID 1 16

Configuration ID 2 16

Connections 8, 11

Control Type - Thermostat 31

Cool-Down Delay (During Occupied Time Period) 47

Cooling Stages 31

CORE Service App 11

CORE Unit Controller

Layout and Connections 6

CORE Unit Controller Overview 6

D

Dehumidification Operation

Humiditrol Dehumidification Operation — (Humiditrol® Reheat) 70

Selecting Minimum Low and Minimum High Damper Positions 99

Third Party Digital Input to Control Dehumidification 71

Demand Control Ventilation (DCV)

Determining Indoor Air Quality Inputs 78

Parameter Adjustments 77

Set Point Control Option 78

Dirty Filter Switch (S27- Optional) 46

Discharge Air Control

Cooling 84

Heating 85

E

Economizer

Damper Operation During Free Cooling 74

Economizer Checkout 75

Enabling Economizer and Settings 74

Enthalpy Set Point 75

Free Cooling Compressor Lockout Mode and Low Ambient Set Point 74

Free Cooling Damper Maximum Position 75

General 74

Outdoor Air Suitable for Free Cooling 74

Economizer - Global Menu Structure 23

Economizer - Single or Dual Enthalpy Menu Structure 24

Economizer - Temperature Menu Structure 23

Electric Heat Operation—Electric / Electric Units

Electric Heat Stage Delay Operation 48

F

Firmware - Cloud Update 11

Flame Roll-Out Switches (S47 and S69) 44

Freezestat 43

G

Gas and Electric Heat Warm-Up Mode (During Occupied Time Period) 47

Gas Heat Operation—Gas Units

Heat Speeds 47

Gas Heat Valve Delays 45

Gas Units Burner Protection and Delays

Flame Roll-Out Switches (S47 and S69) 44

Primary or Secondary Limits (S10 and S99) 44

Gas Valve Sensor Activation Feedback 45

H

Heating and Cooling Stages in Room Sensor Mode 39

High Pressure Switches (S4, S7, S28 and S96) 44

I

Inputs/Outputs and LED Locations 8

J

Jumpers 8

L

L Connection Network Back-Up Mode 39

LED Locations 8

LED Operation Indicators 9

LonTalk Menu Structure 20

Loss of Power Detection (Single-Phase Units Only) 44

Low GWP Refrigerant Detection System 42

- Alarms 42
- Mitigation Actions 42
- Sensor Placement 43
- Sensors 42
- User Test 42

Low Pressure Switches (S87, S88, S97 and S98) 44

M

Menu Navigation - CORE Service App 17

Menu Selection Overview 14

MODBUS 8

Model Number 15

Motorized Outdoor Air Damper Only Menu Structure 22

N

Network Integration Menu 18

O

Open Proof Alarms 45

Outdoor Fan Operations

- Compressor / Fan Configurations 52, 53
- High Ambient Conditions 52

Overflow Switches (S149 / S179 - Optional) 46

P

Phase - Voltage Detection 125

Power Exhaust and Edit Parameter 30

Primary or Secondary Limits (S10 and S99) 44

R

Report 28

Return Air Temperature Limits 45

Room Sensor Back-up Modes 38

Room Sensor Back-Up Mode Set Points 38

Room Sensor Mode 47

Room Sensor Parameters 40

RTU Options 29

RTU Options - Blower, Damper and Dehumidifier 29

S

Safety Switch Input (A42-Optional) 46

S-Bus Menu Structure 21

Sensors

Carbon Dioxide (Indoor Air Quality) Sensor - Optional 50

Enthalpy Sensor - Optional 51

Relative Humidity Sensor - Optional 50

Room Sensor - Optional 50

Temperature Sensors - Provided With Unit 50

Sequence of Operation

CAV Units in Single-Zone Applications with a Lennox Room Sensor 94

Unit Controller Control Modes 92

Service 26

Service Relays 125

Smoke Detector (A171 and A172 - Optional) 46

Start-up Delay in Room Sensor Mode 39

Status Codes 9

Supply Air Delivery

Blower Delays 81

Cooling Operation 81

Gas / Electric Units 81

Supply Constant Air Volume (CAV) with Zone Bypass Damper Control 82

Supply Multi-Stage Air Volume (MSAV) Control Mode 81

Variable Frequency Drive Control 82

Supply Static Pressure Sensor - Optional

Supply Static Pressure Sensor - Optional 51

System Data / Sensor Data / Output 26

System Mode - Room Sensor Backup Mode Set Points 38

System Status Screen 11

T

Test and Balance 22

Thermal Protection Switches 43

Thermostat Bounce Delay (Wired Thermostat Mode Only) 45

Third-Party Zoning 86

Air Delivery Operation 87

Cooling Operation 87

Heating Operation 87

Occupied /Unoccupied Operation 87

Power Exhaust Operation 87

U

Unit Sizes 6

USB Flash Drive Interface Usage 8

W

Wired Thermostat Mode 47

Wireless Gateway 11