

10 Model: LGT, LCT 036H - 072H Y VOLT
 COOLING - EBM BLOWER WITHOUT HIGHER SCCR
 Voltage: 208-240V/3~/60Hz (Y)
 Supersedes: N/A Form No: 538188-01 Rev: 3

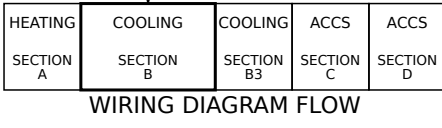

← DENOTES OPTIONAL COMPONENTS AND WIRING

WARNING
 DISCONNECT ALL POWER BEFORE SERVICING.
 ELECTRIC SHOCK HAZARD, CAN CAUSE INJURY OR DEATH. UNIT MUST BE GROUNDED IN ACCORDANCE WITH NATIONAL AND LOCAL CODES.
 FOR USE WITH COPPER CONDUCTORS ONLY. REFER TO UNIT RATING PLATE FOR MINIMUM CIRCUIT AMPACITY AND MAXIMUM OVERCURRENT PROTECTION SIZE.
 IF ANY WIRE IN THIS APPLIANCE IS REPLACED, IT MUST BE REPLACED WITH WIRE OF LIKE SIZE, RATING AND INSULATION THICKNESS.

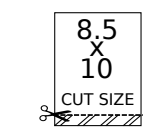

REV	EC NO.	DATE	BY	APVD	REVISION NOTE
--	CN-008852	06/01/2022	AXL	AAH	ORIGINATED AT PD&R CARROLLTON, TX
2	CN-014014F	1/6/2026	ZN	AWH	A) CLEANED UP WIRES TO GAS SECTION (A-SECT)
3	CN-013731A	3/3/2026	ZN	HMT	A) ADDED NOTE 6 FOR MODULATING GAS HEAT

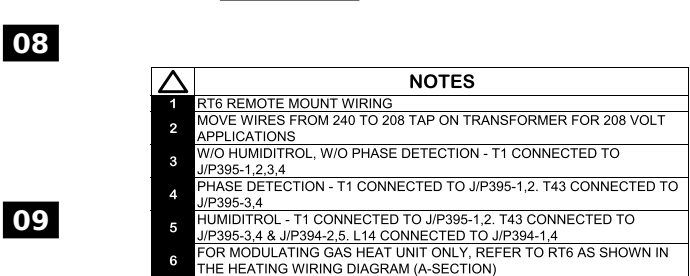
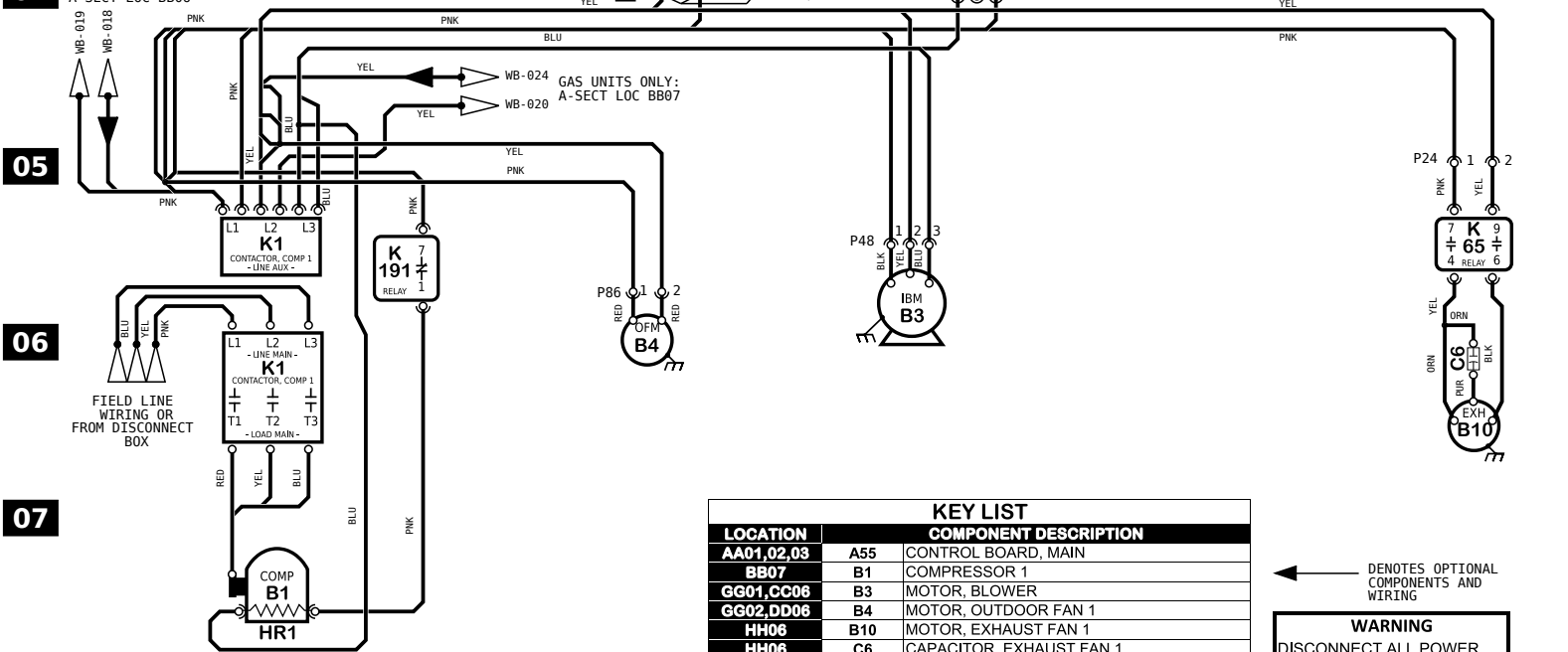
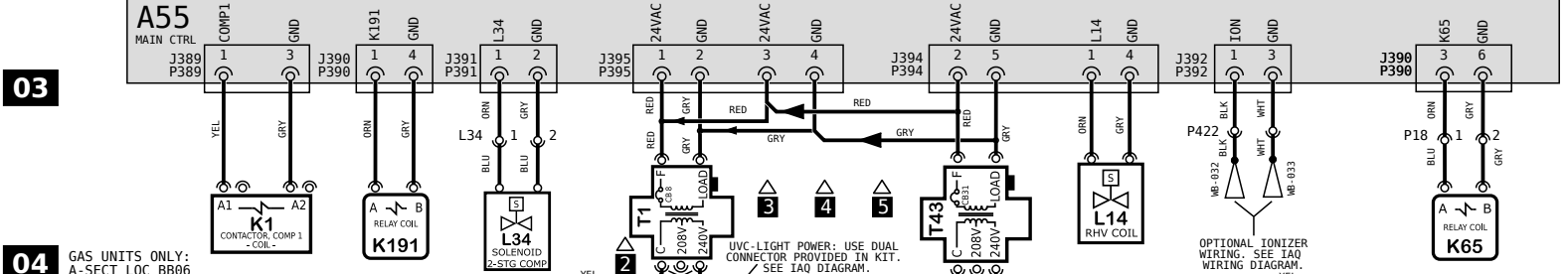
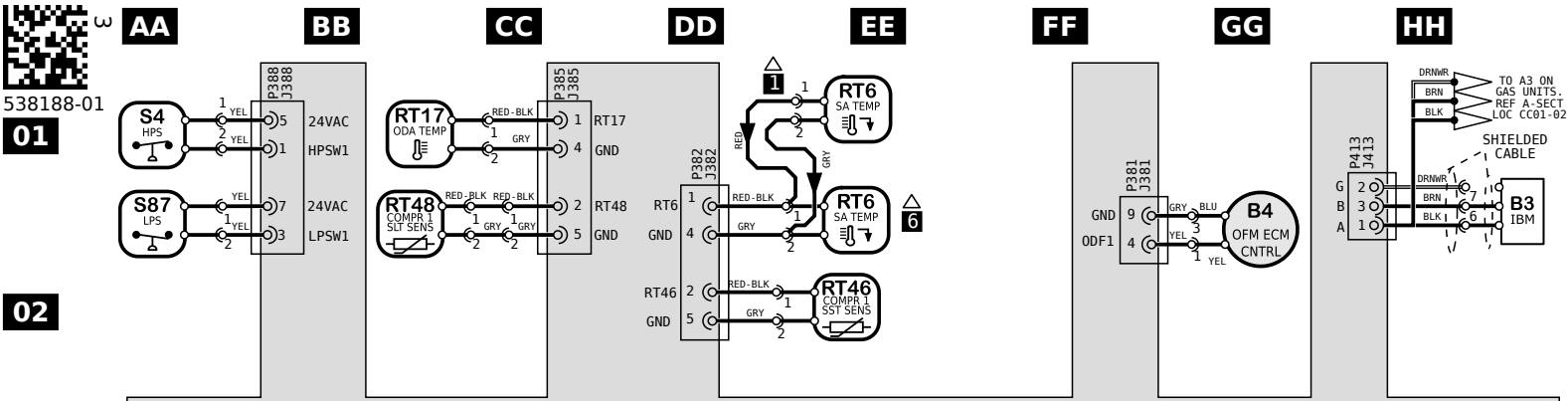

KEY LIST		
LOCATION	COMPONENT	DESCRIPTION
AA01,02,03	A55	CONTROL BOARD, MAIN
BB07	B1	COMPRESSOR 1
GG01,CC06	B3	MOTOR, BLOWER
GG02,DD06	B4	MOTOR, OUTDOOR FAN 1
HH06	B10	MOTOR, EXHAUST FAN 1
HH06	C6	CAPACITOR, EXHAUST FAN 1
BB07	HR1	HEATER, COMPRESSOR 1
BB04,05,06	K1	CONTACTOR, COMPRESSOR 1
HH04,05	K65	RELAY, EXHAUST FAN 1
BB04,06	K191	RELAY, CRANKCASE HEATER 1
FF04	L14	VALVE, SOLENOID, REHEAT COIL 1
CC04	L34	VALVE, SOLENOID, 2 STG COMPRESSOR
EE01	RT6	SENSOR, A55 DISCHARGE (IMC)
CC01	RT17	SENSOR, OUTSIDE AIR TEMP
EE02	RT46	SENSOR, SAT. SUCT TEMP., COMP 1
CC02	RT48	SENSOR, SAT. LIQUID TEMP., COMP 1
AA01	S4	LIMIT, HI PRESS. SWITCH, COMP 1
AA01	S87	SWITCH, LOW PRESS., COMP 1
DD04	T1	TRANSFORMER, CONTROL
EE04	T43	TRANSFORMER, REHEAT

NOTES	
1	RT6 REMOTE MOUNT WIRING
2	MOVE WIRES FROM 240 TO 208 TAP ON TRANSFORMER FOR 208 VOLT APPLICATIONS
3	W/O HUMIDITROL, W/O PHASE DETECTION - T1 CONNECTED TO J/P395-1.2,3,4
4	PHASE DETECTION - T1 CONNECTED TO J/P395-1.2. T43 CONNECTED TO J/P395-3,4
5	HUMIDITROL - T1 CONNECTED TO J/P395-1.2. T43 CONNECTED TO J/P395-3,4 & J/P394-2,5. L14 CONNECTED TO J/P394-1,4
6	FOR MODULATING GAS HEAT UNIT ONLY, REFER TO RT6 AS SHOWN IN THE HEATING WIRING DIAGRAM (A-SECTION)

← DENOTES OPTIONAL COMPONENTS AND WIRING

WARNING
DISCONNECT ALL POWER BEFORE SERVICING.
ELECTRIC SHOCK HAZARD, CAN CAUSE INJURY OR DEATH. UNIT MUST BE GROUNDED IN ACCORDANCE WITH NATIONAL AND LOCAL CODES.
FOR USE WITH COPPER CONDUCTORS ONLY. REFER TO UNIT RATING PLATE FOR MINIMUM CIRCUIT AMPACITY AND MAXIMUM OVERCURRENT PROTECTION SIZE.
IF ANY WIRE IN THIS APPLIANCE IS REPLACED, IT MUST BE REPLACED WITH WIRE OF LIKE SIZE, RATING AND INSULATION THICKNESS.

10 Model: LGT, LCT 036H - 072H Y VOLT
COOLING - EBM BLOWER WITHOUT HIGHER SCCR
Voltage: 208-240V/3~/60Hz (Y)
Supersedes: N/A Form No: 538188-01 Rev: 3

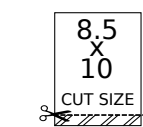
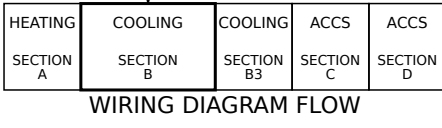

REV	EC NO.	DATE	BY	APVD	REVISION NOTE
--	CN-008852	06/01/2022	AXL	AAH	ORIGINATED AT PD&R CARROLLTON, TX
2	CN-014014F	1/6/2026	ZN	AWH	A) CLEANED UP WIRES TO GAS SECTION (A-SECT)
3	CN-013731A	3/3/2026	ZN	HMT	A) ADDED NOTE 6 FOR MODULATING GAS HEAT