

Job Name _____
 Purchaser _____
 Submitted to _____
 Unit Designation _____

Location _____
 Engineer _____
 Reference Approval Construction
 Schedule # _____

System Specifications

Performance	US Ton (nominal)		10	
	Rated Capacity (Btu/h)	Cooling	95°F Ambient, Entering Temperature: 55°F, Leaving Temperature: 44°F	120,000
		Heating (Dry/Wet Bulb: 47/43°F)	Leaving Temperature: 105°F	128,000
			Leaving Temperature: 120°F	120,000
		Heating (Dry/Wet Bulb: 17/15°F)	Leaving Temperature: 105°F	84,000
	Leaving Temperature: 120°F		80,000	
	Power Input (A)	Cooling	95°F Ambient, Entering Temperature: 55°F, Leaving Temperature: 44°F	28.4
		Heating (Dry/Wet Bulb: 47/43°F)	Leaving Temperature: 105°F	26.7
			Leaving Temperature: 120°F	31.5
		Heating (Dry/Wet Bulb: 17/15°F)	Leaving Temperature: 105°F	30.0
Leaving Temperature: 120°F	32.7			
Cooling EER			11.54	
Heating COP	Heating (Dry/Wet Bulb: 47/43°F)	Leaving Temperature: 105°F	3.84	
		Leaving Temperature: 120°F	3.05	
	Heating (Dry/Wet Bulb: 17/15°F)	Leaving Temperature: 105°F	2.24	
Leaving Temperature: 120°F			1.96	
IPLV			21.53	



Construction

The unit shall be EGI (electronic galvanized steel) with a baked on powder coated finish. The unit brackets shall be GI (hot-dipped galvanized steel)

Air Side Heat Exchanger

The heat exchanger shall be mechanically bonded fin to copper tube.

The aluminum fins of the heat exchanger shall have a protective coating.

Salt spray test method: ASTM B117-18 - the heat exchanger showed no unusual rust or corrosion development to 2,280 hours.

Water Side Heat Exchanger

The heat exchanger shall be brazed plate type (2)

A field provided gas separator is required on the water outlet pipe to vent high pressure gas in the event of water side heat exchanger leakage.

Controls

The unit shall be operated via NASA Protocol with controls provided by Lennox

Can connect up to 16 X VPD0**C*M-** Chillers to a single Chiller module controller (VCTRL03P-1) to provide various system operation configuration, setup, monitoring, status, and error notification (VCTRL03P-1 is required for operation.)

The outdoor unit shall have a removable EEPROM that stores unit serial number, startup information, system settings, system tag/name, and other information.

Optional FCU Kit (fan coil unit) available to control and integrate fan coil units to Lennox central and local controls (FCU Kit: VCTRL04P-1; FCU Kit Central Control Interface Module: VCTRL05P-1).

Control wiring shall be 16 AWG X 2 shielded wire (for communicating controls connections).

Refrigerant System

The compressors shall be Lennox hermetically sealed, inverter driven, direct flash injected, DC scroll type with soft-start capability.

The refrigerant system capacity shall modulate based on demand.

Flash injected compressors provide advanced low ambient heating performance.

Refrigerant flow shall be controlled by EEV (electronic expansion valve).

Other Features

Asymmetrical scroll design with rotating compressor operation/priority.

Optional night quiet modes to reduce outdoor unit sound (default mode and levels 1-3) with automatic or manual activation.

Advanced intelligent defrost logic to significantly reduce defrost cycle frequency by monitoring air resistance across the condenser coil during heating operation to determine defrost operation initiation to prevent unnecessary defrost cycles. In applications where 2-16 modules are configured and controlled as one system, only 30% or less of the total nominal capacity will enter defrost operation at a time (ex: 6 module system - only one module will defrost at a time; 8 module system - two modules may enter defrost at a time).

Optional snow blowing logic to prevent snow accumulation on idle units (enabled by default, can be disabled at any time)

Error reset with dry input at outdoor unit (refer to pages 4-5 for input/output details)

Three operation patterns can be selected: Standard, Rotation, and Efficiency (refer to page 6 for details)

Operation patterns can be adjusted at Chiller unit or at controllers (refer to page 7 for details)

Energy savings options to reduce system energy consumption by configuring Water Law (outdoor reset) control to automatically adjust leaving water set temperature based on ambient temperature or room temperature. Room temperature (heating and cooling, two points each), outdoor temperature (heating and cooling, two points each), and water temperature (heating and cooling, two points each) settings can be configured when using Water Law control. Water Law can be based on outdoor temperature or indoor temperature. Water Law based on room temperature requires installation of PT1000 temperature sensor (field provided) in the space to monitor room temperature (refer to page 6 for details).

Power	Voltage	(ø)V/Hz	3 / 208 - 230 / 60
	Maximum Circuit Breaker (MCCB/ELB/ELCB)		70
	Minimum Circuit Ampacity (MCA)		52
	SCCR	kA	5

Compressor	Type		Inverter Driven Scroll X 2
	RLA	A	19

Refrigerant	R32 Factory Charge	Lbs.	30.4
-------------	--------------------	------	------

Water Side Heat Exchanger	Connection Type		50A Cut Groove
	Quantity		2
	Water Flow (GPM)	Minimum	15.8
		Nominal	24
Maximum		48	
Minimum Water System Volume		Gallons	72

Condenser Fan	Fan	Type	Propeller X 2
		Output (max.)	CFM
	Motor	Type	BLDC
		Output	W
		FLA	A
	Max. External Static Pressure		"WC

Dimensions	W X H X D		Inches	70 11/16 X 66 3/4 X 30 1/8
	Weight	Net	Lbs.	959
		Shipping	Lbs.	1,008

Sound Level	Sound Pressure	dB (A)	55
-------------	----------------	--------	----

Operating Water Temperature Range	Cooling	Standard	°F (°C)	41 ~ 77°F (5 ~ 25°C)
		When Using Brine	°F (°C)	14 ~ 77°F (-10 ~ 25°C)
	Heating ¹	°F (°C)	77 ~ 140°F (25 ~ 60°C) ¹	

Operating Ambient Temperature Range	Cooling	°F (°C)	5 ~ 118°F (-15 ~ 48°C)
	Heating	°F (°C)	-13 ~ 109°F (-25 ~ 43°C)

Safety Certifications	ETL & ETLc
-----------------------	------------

Protection Devices	Intelligent logic to ensure proper operation within unit design limitations and operational parameters		
	High pressure sensor, low pressure sensor, over-voltage protection, compressor over-current protection, current transformer, fan motor voltage protection, fan motor thermal protection, overheat protection, phase detection protection, high voltage fuses, water pressure sensors		
	Inverter PCB cooling done with liquid refrigerant to maintain optimal and safe operating temperatures		

¹ When outside temperature is below 50°F (10°C), the maximum outlet temperature is 131°F (55°C).

Units are certified in the AHRI Air-Cooled Water-Chilling Package (ACCL) Certification Program to AHRI Standard 550/590. Ratings displayed may or may not be certified under AHRI ACCL certification program. Refer to LVSS 2.0 for complete certification details. Heat Pump Water-Heating unit is certified when operating in cooling. Certified units may be found in the AHRI Directory at www.ahridirectory.org. Combined performance of multiple chillers are not AHRI Certified.

Lennox HVAC maintains a policy of ongoing development, specifications are subject to change without notice.



Accessories

Qty.	Model Number	Description
	V1GARD12-4P	Top wind/hail guard
	V1GARD10-4P	Left side wind/hail guard
	V1GARD11-4P	Right side wind/hail guard
	V1GARD09-4P	Rear wind/hail guard (two required)
	VCTRL03P-1	Module Controller for Chiller
	VSTAT10P-1	External contact control interface module (operation and error output, night silent mode manual activation)

Control Points

Chiller control points are adjustable at the controllers/point of control noted below.

Control option	Point of Control (X = supported)				Chiller dry contact
	Chiller module controller	Central control gateway			
	VCTRL03P-1	DMS2.5 (VCTRL09P-1)	BACnet (VCTRL02P-1)		
Operation ON/OFF	X	X	X		X
Mode: cool, heat, cool storage, hot water	X	X	X		X
Operation pattern: standard, rotation, efficiency	X	X			
Enable/disable Water Law (adjustable temperature settings of Water Law)	X ¹	X	X		X ²
Enable/disable quiet mode (default mode and quiet mode levels 1-3 are selected during system commissioning)	X ¹	X	X		X ²
Forced fan mode	X	X	X		X
Demand/maximum current control of module chiller(s): limit current 50% - 100% of design current	X ¹	X	X		X ²

¹ The setting value is adjustable on VCTRL03P-1 service mode.

² Adjust the setting value on Hydro controller option setting on Chiller unit

SUBMITTAL VPD010C6M-5Y
Heat Pump Chiller Dimensional
Drawing

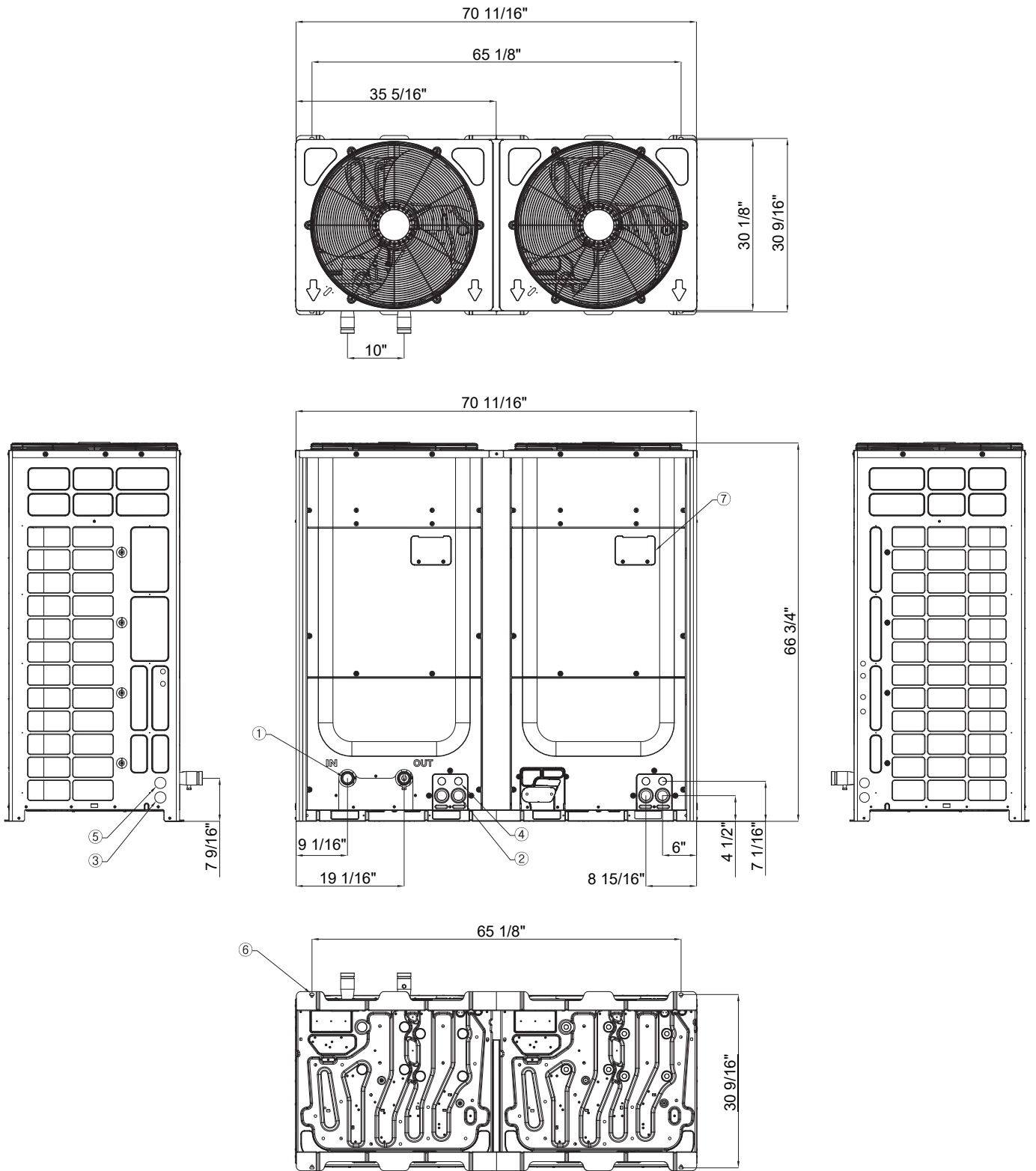

No.	Description	No.	Description
1	Water connections	5	Communication wiring conduit opening (side)
2	Power wiring conduit opening (front)	6	Anchor bolt hole
3	Power wiring conduit opening (side)	7	PCB monitoring window
4	Communication wiring conduit opening (front)		

Output contact for individual Chiller units

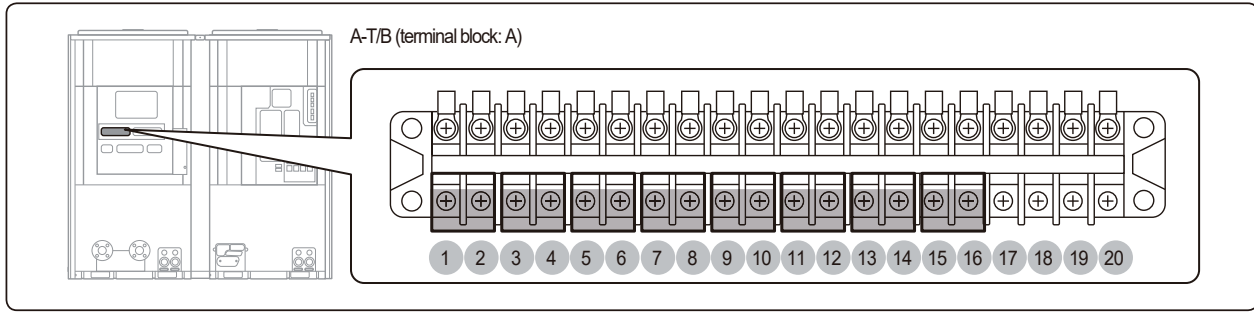

No.	Name	Signal	Function	Contact Short	Contact Open	
A-T/B	1-2	Cooling/Heating display	Displays when operating in heat mode	Heat	Cool	
	3-4	Operation display	Displays while system is operating	Operate	Stop	
	5-6	Warning display	Displays when error occurs	Error occurred	No error	
	7-8	Defrost operation display	Displays when defrosting	Defrost ON	Defrost OFF	
	9-10	Pump operation display	Displays when pump operates	Pump ON	Pump OFF	
	11-12	Compressor operation display	Displays when compressor operates	Compressor ON	Compressor OFF	
	13-14	Pump operation	Signal of pump operation	Pump signal ON	Pump signal OFF	
	15-16	Freeze protection display	Displays when freeze protection is enabled	Pump ON for freeze protection	Others	
	17-18	Not used	-	-	-	-
	19-20	Not used	-	-	-	-

Refer to technical data book and installation manual for complete operation and control details.

Example of output contact installation

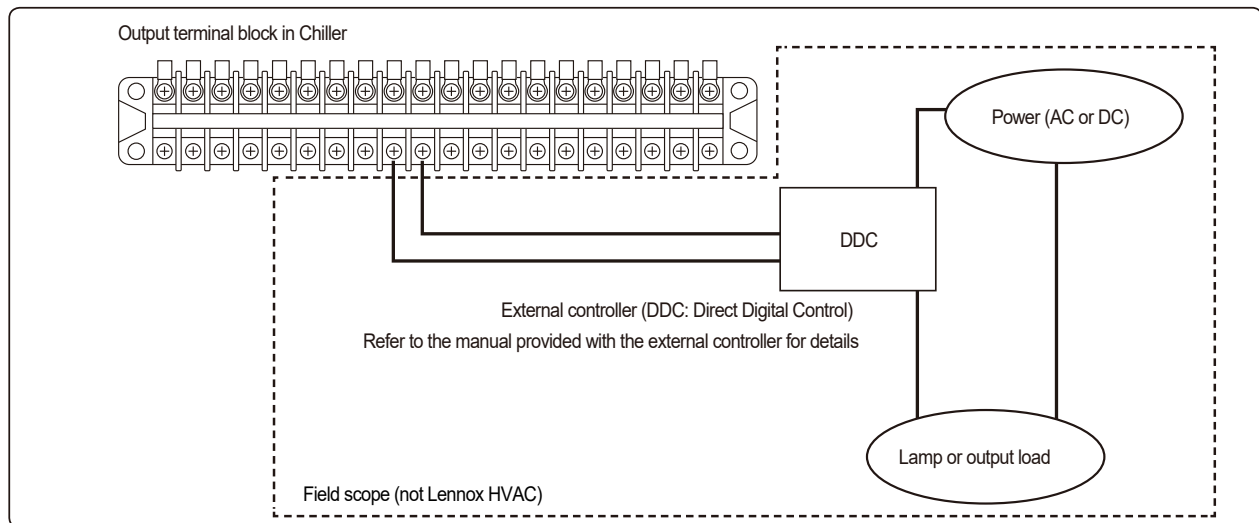

Refer to technical data book and installation manual for complete operation and control details.

Lennox HVAC maintains a policy of ongoing development, specifications are subject to change without notice.

Input contacts

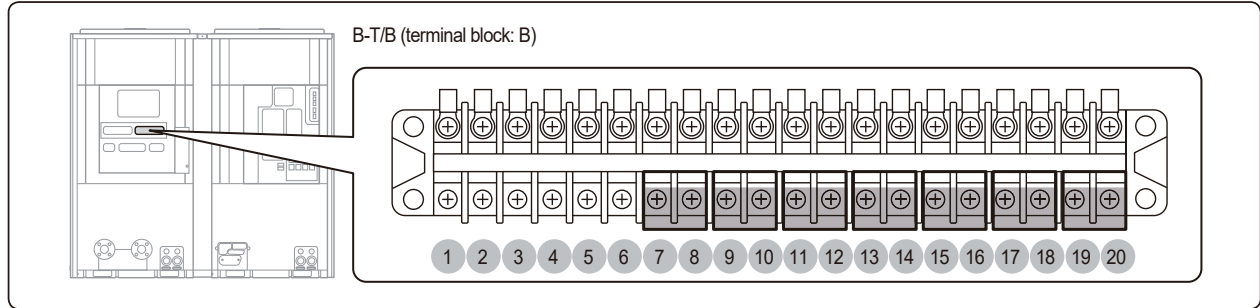

No.	Name	Signal	Function	Contact Short	Contact Open	Signal recognition	Setting unit
1-6	Not used	-	-	-	-	-	-
7-8	Pump interlock	Zero voltage contact	Pump operation signal • Pump interlock error (E918) occurs if input is not on when operating pump	Pump ON	Pump OFF	Usual input Note 2)	Each unit
9-10	Operation ON/OFF		Controlling operation ON/OFF Note 3)	Note 5)		Usual/instant input Note 2)	Main unit of group Note 6)
11-12							
13-14	Operation mode		Selecting cool/heat mode Note 4)	Heat	Cool	Usual input Note 2)	Main unit of group Note 6)
15-16	Hot water (Cool storage) mode Note 1)		Entering hot water (cool storage) mode by external control • Cool + ON: Cool storage • Heat + ON: Hot water	Cool storage/ Hot water	Cool/Heat	Usual input Note 2)	Main unit of group Note 6)
17-18	Hot water (Cool storage) control standard Note 1)		Control depending on set temperature when ON Control depending on external hot water (cool storage) thermostat when OFF	Control by set temperature	Control by thermostat	Usual input Note 2)	Main unit of group Note 6)
19-20	Hot water (Cool storage) thermostat signal Note 1)		When thermostat is set as standard for hot water (cool storage) mode • Thermo ON when ON (Not over range of water outlet temperature) • Thermo OFF when OFF	Thermo ON	Thermo OFF	Usual input Note 2)	Main unit of group Note 6)

Note 1) To use hot water (cool storage) mode, the function should be activated by Module Controller (VCTRL03P-1). Note 2) Input types:

- Usual input: Operate by current status of contact (switch).
- Instant input: Operate when contact signal changes from OFF to ON / from ON to OFF (push button).

Note 3) Operates when input method of operation On/Off is set as external contact

Note 4) Operates when input method of operation mode is set as external contact

Note 5) Operation depending on external contact operation ON/OFF input method

- When set as usual input (0): Operation ON when 9-10 is ON; OFF when 9-10 is OFF
- When set as instant input (1): Operation ON when 9-10 is ON more than 0.1 second; OFF when 11-12 is ON more than 0.1 second

Note 6) Main unit of module when group is not available

Refer to technical data book and installation manual for complete operation and control details.

Refer to technical data book and installation manual for complete operation and control details.

Lennox HVAC maintains a policy of ongoing development, specifications are subject to change without notice.

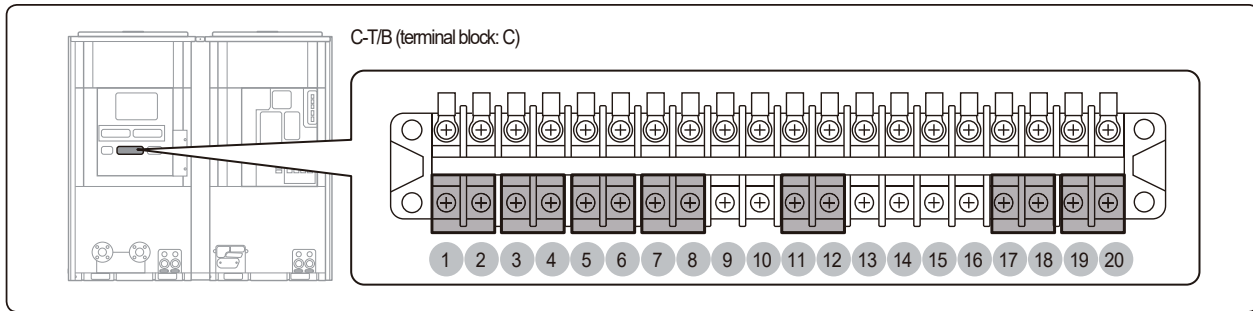
Heat Pump Chiller
Input Contacts (continued)

No.	Name	Signal	Function	Contact Short	Contact Open	Signal recognition	Setting unit	
C-T/B	1-2	Quiet function	Zero voltage contact	Operate quiet function in level set by main option or module control ^{Note 4)}	Quiet function	-	Usual input ^{Note 9)}	Main unit of group ^{Note 8)}
	3-4	Demand function		Operate demand function (current limit control) at level set by main option or module control ^{Note 5)}	Demand function	-	Usual input ^{Note 9)}	Main unit of group ^{Note 8)}
	5-6	Forced fan function		Operate forced fan function ^{Note 6)}	Forced fan function	-	Usual input ^{Note 9)}	Main unit of group ^{Note 8)}
	7-8	Unusual condition (error) reset		Reset error status • Operates only when remote error reset input function is enabled	Reset error	-	Instant input ^{Note 9)}	Main unit of module
	9-10	Not used	-	Not used (N/A)	-	-	-	-
	11-12	Water law (refer to page 6 for details)	Zero voltage contact	Operate water law ^{Note 7)}	Water law control	Water outlet set temperature control	Usual input ^{Note 9)}	Main unit of group ^{Note 8)}
	13-14	Not used	-	Not used (N/A)	-	-	-	-
	15-16	Not used	-	Not used (N/A)	-	-	-	-
	17-18	Set temperature/ room temperature sensor	Analog current	Recognize water outlet set temperature by external input (4 ~ 20 mA) ^{Note 1)} Recognize value of room temperature sensor (4 ~ 20 mA) when standard for water law is room temperature ^{Note 2)}	-	-	Current input	Main unit of group ^{Note 8)}
19-20	External water outlet temperature	Analog current	Recognize external water outlet temperature by external temperature sensor (4 ~ 20 mA) ^{Note 3)}	-	-	Current input	Main unit of group ^{Note 8)}	

^{Note 1)} Refer to technical data book for more details and sensor information

^{Note 2)} Refer to technical data book for more details and sensor information

^{Note 3)} If operation pattern is not standard control, control standard temperature depends on external water outlet temperature sensor. External water outlet temperature sensor should be installed where it can represent the temperature of the water pipe system. Refer to technical data book for full details.

^{Note 4)} Operates when input method for quiet function is set as external contact
 - If the contact is closed (short), quiet function operates in Cool/Heat mode.
 - Quiet function by Module Controller operates in Cool mode and night time.

^{Note 5)} Operates when input method for demand function is set as external contact

^{Note 6)} Operates when input method for forced fan function is set as external contact

^{Note 7)} Operates when input method for water law function is set as external contact

^{Note 8)} Main unit of module when group is not available

^{Note 9)} Input types:

- Usual input: Operate by current status of contact (switch).

- Instant input: Operate when contact signal changes from OFF to ON / from ON to OFF (push button).

NOTE: Room temperature and external water outlet temperature sensors are not supplied. Purchase and install the appropriate sensor according to the usage.

- Room temperature sensor : 4mA: -50°C (-58°F), 20mA: 50°C (122°F)

- External water outlet temperature sensor: 4~20mA (4mA: -30°C (-22°F), 20mA: 70°C (158°F))

Refer to technical data book and installation manual for complete operation and control details.

Lennox HVAC maintains a policy of ongoing development, specifications are subject to change without notice.

Water Law Details

Water Law standards can be configured for cooling and heating operating mode. Water law can be enabled to change the water outlet temperature based on demand load changes according to outdoor or indoor temperature.

Water Law configuration according to outdoor temperature

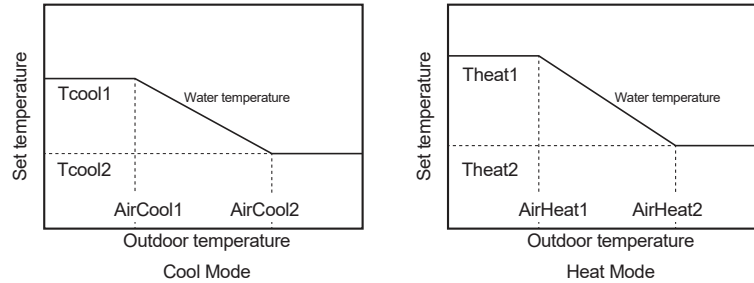

NOTE:

If the unit is not a low temperature water model, the set temperature decided by the Water law control will not decrease below 41°F.

Tcool1, Tcool2, AirCool1, AirCool2, AirHeat1, and AirHeat2 will be configured at the Chiller unit during system commissioning or at controllers noted above.

Water Law configuration according to indoor temperature (when using an external temperature sensor)

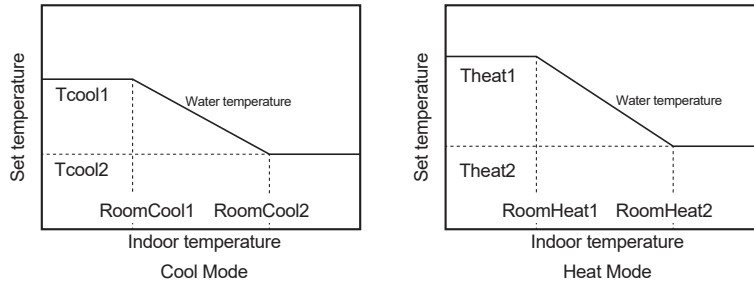

NOTE:

If the unit is not a low temperature water model, the set temperature decided by the Water law control will not decrease below 41°F.

Tcool1, Tcool2, RoomCool1, RoomCool2, RoomHeat1, and RoomHeat2 will be configured at the Chiller unit during system commissioning or at controllers noted above.

Refer to technical data book and installation manual for complete operation and control details.

Lennox HVAC maintains a policy of ongoing development, specifications are subject to change without notice.

Standard Control

- All modules start operating at the same time, and each module operates in the operation pattern which set in the installation service mode.
 - The default for each module is Standard control.

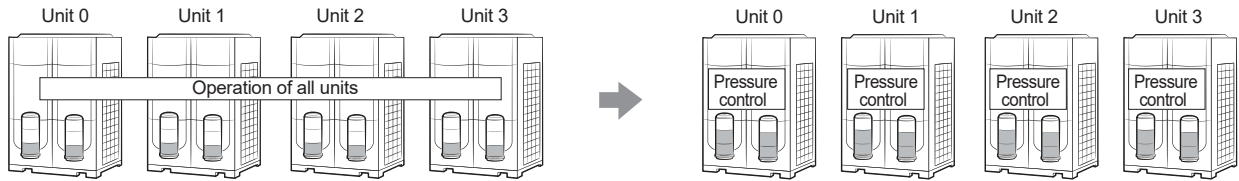

NOTE:
Standard control is suited for applications that always has a high cooling and heating load factor.

Rotation Control

- CHILLER's water outlet temperature is controlled according to the water outlet temperature average value of all operating units in a module. However, if you set "Use" for an external water temperature sensor, it controls the water outlet temperature according to a temperature value from the sensor.
- Modules in a group operate in Standard control.
- The module with the highest priority starts operating first, and if the module reaches full load, a module with the following priority will start operating.
- When the module with the lowest priority operates at the minimum capacity and the water outlet temperature reaches close to the set temperature, the compressors of the module stop.

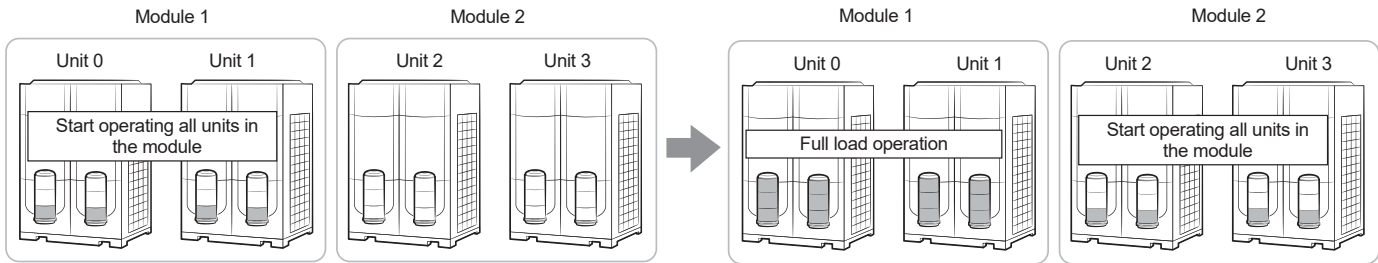

NOTE:
Rotation control is suited for applications that have lower capacities at load side while starting a Chiller and has small fluctuation in momentary load.

Efficiency Control

- CHILLER's water outlet temperature is controlled according to the water outlet temperature average value of all operating units in a module. However, if you set "Use" for an external water temperature sensor, it controls the water outlet temperature according to a temperature value from the sensor.
- Only one unit with the highest priority operates, and if the unit operates with the optimum efficiency, a unit with the following priority will operate.
- When all units reach efficient operating condition, each unit operates at capacity between efficient operating condition and the maximum capacity condition.
- When all units reach efficient operating condition and the water outlet temperature reaches close to the set temperature, the unit with the lowest priority controls decrease compressor operating capacity.

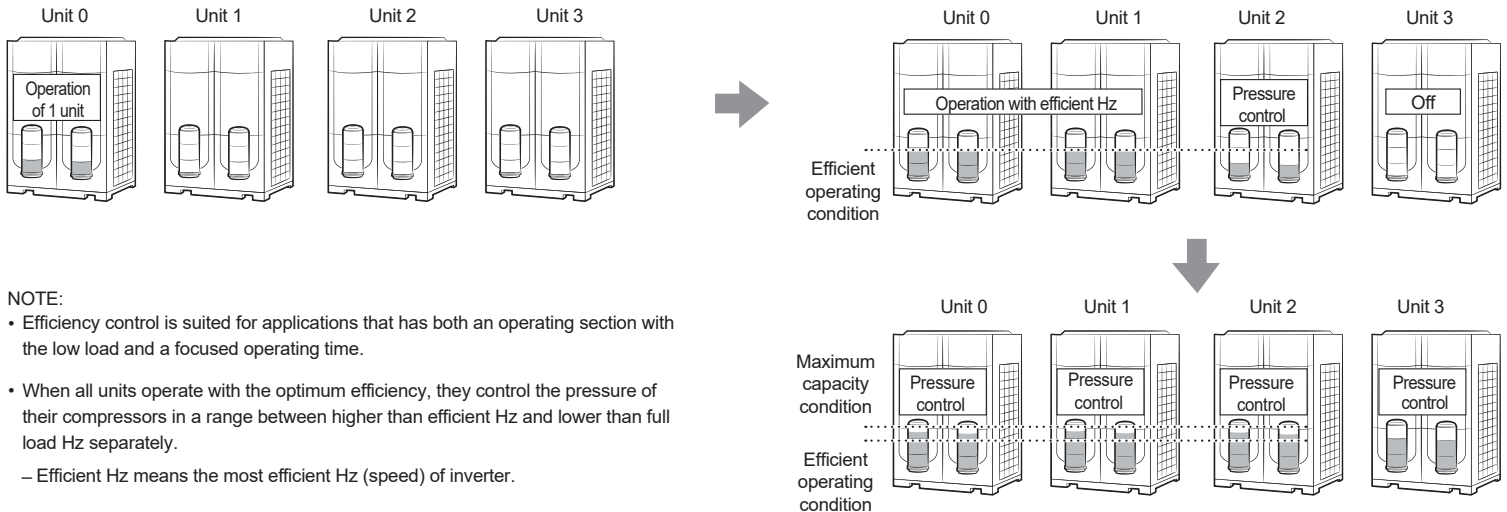

NOTE:
Efficiency control is suited for applications that has both an operating section with the low load and a focused operating time.

- When all units operate with the optimum efficiency, they control the pressure of their compressors in a range between higher than efficient Hz and lower than full load Hz separately.
 - Efficient Hz means the most efficient Hz (speed) of inverter.

Refer to technical data book and installation manual for complete operation and control details.

Lennox HVAC maintains a policy of ongoing development, specifications are subject to change without notice.