

MMD AIR HANDLER | Multi-Zone

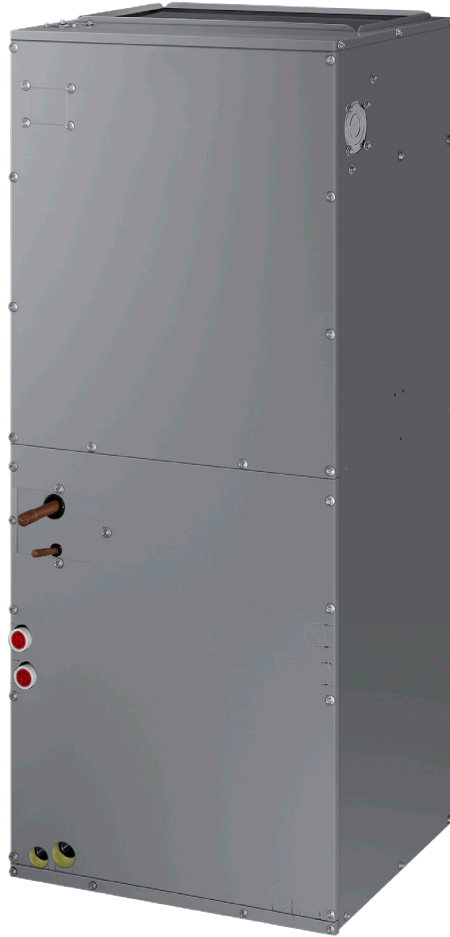

Multi-Position Air Handler Indoor Units | **R-32** | 60 Hz
RESIDENTIAL / COMMERCIAL
PRODUCT SPECIFICATIONS (EHB)

1.5 to 2 Tons
Optional Electric Heat - 3 to 5 kW



MODEL NUMBER IDENTIFICATION

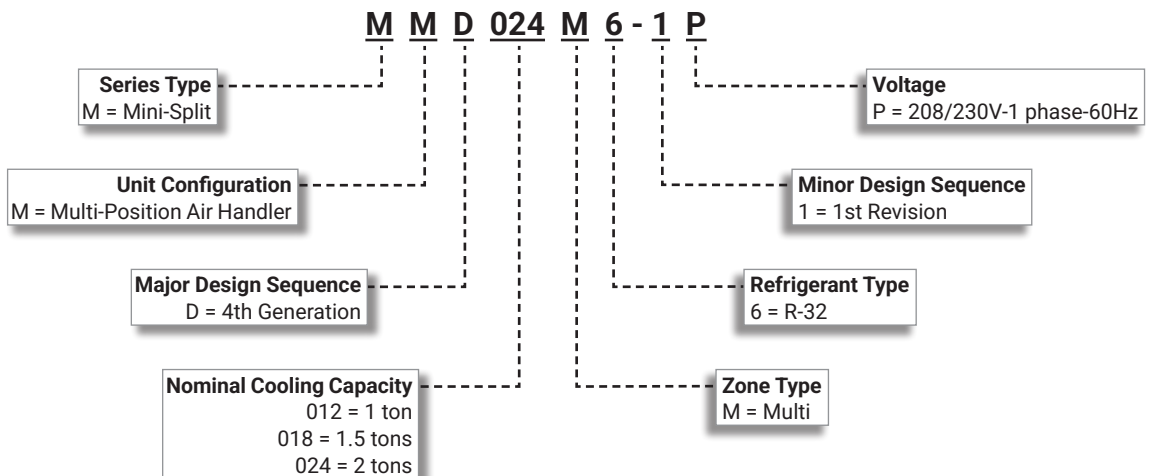

CONTENTS

Approvals And Warranty	2
Blower Data	15
Dimensions	16
Electric Heat Data	14
Features	2
Installation Clearances	14
Mobile Apps	5
Model Number Identification	1
Optional Accessories - Order Separately	13
Optional Control Accessories	12
Remote Controllers - Optional	6

APPROVALS AND WARRANTY

APPROVALS

- Indoor units and components ETL and CEC bonded for grounding to meet safety standards for servicing

WARRANTY

- All covered components
 - Limited five years in all applications
- Accessories and controls - Limited one year

NOTE - Refer to Lennox Basic Limited Warranty at www.Lennox.com for additional details.

FEATURES

APPLICATIONS

- 1 to 2 ton nominal sizes
- Multi-position applications (upflow, downflow and horizontal)
- Optional field installed electric heaters available in several sizes for additive heating capacity

REFRIGERANT SYSTEM

Evaporator Coil

- Copper tube with aluminum fins.
- Twin coil construction assembled in a "A" configuration for large surface area
- Provides excellent heat transfer and low air resistance for maximum efficiency
- Precise circuiting for uniform refrigerant distribution
- Lanced fins provide maximum exposure of fin surface to air stream
- Rifled tubing provides superior heat transfer
- Coil thoroughly factory tested under high pressure to ensure leakproof construction

Refrigerant Line Connections

- Copper refrigerant flare connections on both liquid and gas lines
- Lines extend outside of the cabinet for ease of connection
- See dimension drawings for locations

BLOWER

Constant Torque Blower Motor

- Programmable high efficiency multi-speed DC blower motor
- By maintaining constant torque output, blower motor can deliver more uniform (but not constant) airflow over the static pressure range
- Programmable multi-speed operation is achieved by the use of an ECM (Electronically Commutated Motor) motor
- Leadless blower motor features simple plug-in connections
- Choice of blower speeds is available. See Blower Data tables
- Blower speed change is easily accomplished by a simple wiring change

Blower Assembly

- Statically and dynamically balanced as an assembly before installation in the unit
- Blower motor is resiliently mounted to blower assembly
- Blower slides out of cabinet for servicing

FEATURES

CABINET

- Constructed of heavy gauge galvanized steel
- Pre-painted cabinet finish
- Completely insulated with foil faced fiberglass insulation
- Removable panels provide complete service access
- Filter access door for easy filter replacement
- Electrical inlets provided in sides and top of cabinet
- See dimension drawing for locations

Low Leakage Cabinet

- All models have less than 2% air leakage and meet ANSI/ASHRAE Standard 193-2010 "Method of Test for Determining the Air Tightness of HVAC Equipment"

Multi-Position Capability

- Shipped for upflow and horizontal left-hand discharge
- May be field converted to horizontal right-hand air
- Evaporator coil must be repositioned for horizontal-right or downflow positions

Multi-Position Drain Pans

- Deep, corrosion resistant high temperature engineered polymer drain pans have dual pipe drains
- See dimension drawing

Optional Accessories

Condensate Pumps

- Quietly and efficiently removes condensate
- See Optional Accessories Table for available pumps

Condensate Drain Line

- Non-kinking
- 160 ft. length
- UV stabilized low density white polyethylene

A/C Easy Tee® Condensate Cleanout

- Condensate drain service port
- Flexible and easy to use with nitrogen, water or shop vac
- Screw cap on top allows easy access to condensate drain line

Downflow Conversion Kit

- Includes new indoor coil panel, room temperature sensor holder and all necessary hardware to convert unit to downflow position

Horizontal Support Frame Kit

- Provides support of unit in horizontal applications
- Consists of (2) 1 x 1-1/2 x 32-5/8 in. and (2) 1 x 3 x 53-7/8 in. painted heavy gauge cold rolled steel support channels with assembly and suspending holes
- Bolts and nuts furnished for field assembly
- Suspending rods must be field provided

Side Return Unit Stand (Upflow Only)

- Raises unit 16 in. above floor for side return air duct connection
- Eliminates need for wooden platform construction
- All aluminum construction
- Two adjustable frames fit all sizes

Wall Hanging Bracket Kit (Upflow Only)

- Allows unit to be hung on wall at any height
- Consists of heavy-gauge steel support brackets (one for air handler, one for wall mount)
- Screws furnished for fastening one bracket to unit
- Bolts for fastening one bracket to wall are field provided

Controllers

- Wireless Remote Controller, see page 6
- Touchscreen Wired Controller, see page 8
- Programmable Wired Controller, see page 11

Thermostat Adaptor

- Allows operation with any 24V thermostat

FILTER

- Washable 1 inch filter is furnished
- Magnetic tool-less access
- Filter rack furnished in cabinet for easy filter installation
- See Specifications tables for filter sizes

FEATURES

OPTIONAL ELECTRIC HEAT

- UL listed
- Field install internal to unit cabinet
- Available in several kW sizes
- See Electric Heat tables
- Helix wound nichrome heating elements exposed directly in air stream resulting in instant heat transfer, low element temperatures and long service life
- Each element equipped with accurately located limit control with fixed temperature off setting and automatic reset
- Thermal sequencer relay brings elements on and off line, in sequence and equal increments, with time delay between each
- Initiates and terminates blower operation
- Heating control relay(s) furnished as standard
- Factory assembled with controls installed and wired
- Electric heat control wiring plugs into mating connector on air handler unit

Circuit Breaker

- All heaters are equipped with circuit breakers for overload and short circuit protection
- Factory wired and mounted on electric heat unit
- Current sensitive and temperature actuated
- Manual reset
- Flexible circuit breaker cover protects circuit breaker in areas with high humidity or unconditioned areas to prevent nuisance tripping
- Circuit breakers qualify as disconnect means at unit in many areas, eliminate the need for field provided disconnect
- Consult local electrical code in your area

MOBILE APPS

Lennox Home App



- The free Lennox Home App is available for use on smartphones.
- The Lennox Home App integrates with the SmartThings app to control Mini-Split system modes and fan operation



SmartThings App



- SmartThings is a free app that uses Wi-Fi to connect smart devices built on the Matter protocol, regardless of the company that makes them
- Users can remotely regulate temperature, adjust settings, receive real-time updates about system performance and energy usage, as well as troubleshoot solutions if service is needed
- Quickly and easily connect, automate and manage your smart home devices through SmartThings
- SmartThings is compatible with hundreds of smart home brands
- With SmartThings, you can connect, monitor and control multiple smart home devices quicker and easier
- Connect smart TVs, smart appliances, smart speakers and brands like Samsung, Ring, Nest and Philips Hue - all from one free app
- Control your smart devices using voice assistant skills including Alexa, Bixby and Google Assistant

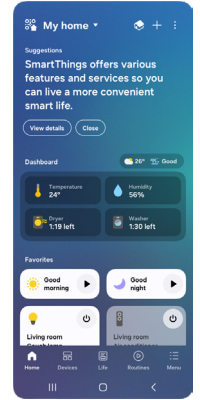

REMOTE CONTROLLERS - OPTIONAL

WIRELESS REMOTE CONTROLLER (V0STAT01P-1)

- Complete remote control of system
- Rechargeable - Two methods:
 - USB Type-C (5V/2A) (cable not furnished)
 - Solar panel on back of controller

NOTE - Features available depend on the type of indoor unit.

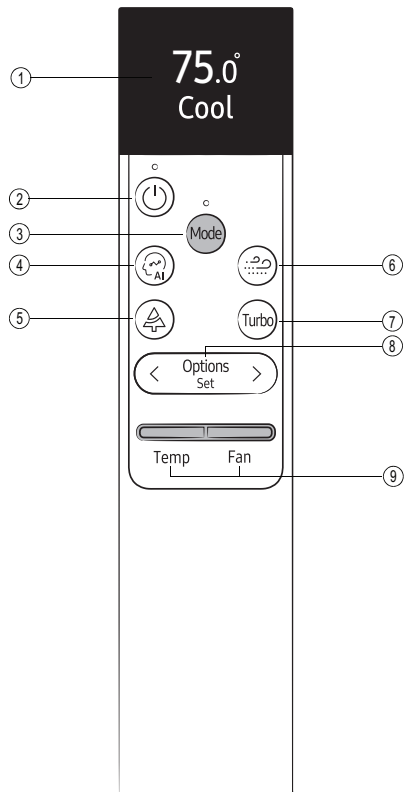

- 1 Display**
 - Shows current operation status and modes
- 2 ON/OFF Button**
 - Turns system on and off
- 3 Mode Button**
 - Select system operation modes
 - Auto, Cool, Dry, Fan, and Heat
- 4 AI Comfort Button**
 - Learns user's use patterns and automatically adjusts temperature level while switching between Cool, Dry, Purify or "Calm Air" modes

NOTE - Only available on indoor models that support this feature.
- 5 Purify Button**
 - Creates a clean room climate by removing harmful substances from the air
 - Can be used in air conditioner or fan only mode

- 6 "Calm Air" Button**
 - Operates during Cool, Dry, or Fan mode
 - Closes the louvers and allows air through the holes in the panel
 - When louvers are closed thousands of micro holes in panel provide a dispersed, gentle flow of air defined as "still air"

NOTE - Only for models equipped with louvers.

During the "Calm Air" Cooling operation, air flow blades may open to control indoor air currents smoothly, depending on the installation settings. As soon as the indoor temperature and humidity changes, the air flow blades will close and "Calm Air" Cooling operation resumes.

- 7 Turbo Button**
 - Enables rapid cooling or heating to increase or decrease temperature in the area

NOTE - After 30 minutes system returns to normal operating condition.
- 8 Options Button**
 - Press to select different functions (see page 7)
 - Left and right arrows scroll through function selections
- 9 Temp/Fan Buttons**
 - Adjust the temperature or fan speed

Temp Button

 - Push the button up or down to adjust the temperature
 - Auto/Cool/Dry mode - 65 to 86°F (1°F degree increments)
 - Fan mode - Disabled
 - Heat mode - 61 to 86°F (1°F degree increments)

Fan Button

 - Push the button up or down to adjust the fan speed
 - Auto/Dry mode - Auto only
 - Cool/Heat mode - Auto/Low/Medium/High
 - Fan mode - Low/Medium/High

WIRELESS REMOTE CONTROLLER MENUS AND FUNCTIONS (VSTAT01P-1)

NOTE - Press the “Options” button to Start. The display changes to match the menu function selected. Left and right arrows scroll through function selections.

NOTE - Functions available depend on the type of indoor unit.

NOTE - Initial Settings for Indoor Unit - Options Button → Model Selection (set) → Standard (set) → Temp Unit → °F or °C (set)

Functions Available When Controller is “ON”		Functions Available When Controller is “OFF”	
Main Menu	Sub-Menu	Main Menu	Sub-Menu
← Back	---	← Back	---
Auto Clean	---	Auto Clean	---
Timer/Good Sleep →	← Back Timer Off Timer On Good Sleep Cancel	Timer/Good Sleep →	← Back Timer Off Timer On Good Sleep Cancel
Motion Detection →	← Back Air Direction Power Saving	Motion Detection →	← Back Air Direction Power Saving
Quiet	---	Freeze Wash	---
Long Wind	---	---	---
Direction →	← Back Fix Vertical Horizontal All	---	---
Blades →	← Back Blade 1 Blade 2 Blade 3 Blade 4	---	---
Zones →	← Back Zone 1 Zone 2 Zone 3 Zone 4	Zones →	← Back Zone 1 Zone 2 Zone 3 Zone 4
Settings →	← Back Beep Lighting AI Diagnostics Model Selection Filter Reset Temp Unit Heating Range Auto Mode	Settings →	← Back Beep Lighting AI Diagnostics Model Selection Filter Reset Temp Unit Heating Range Auto Mode

NOTE - “Back” function returns to the previous function.

REMOTE CONTROLLERS - OPTIONAL

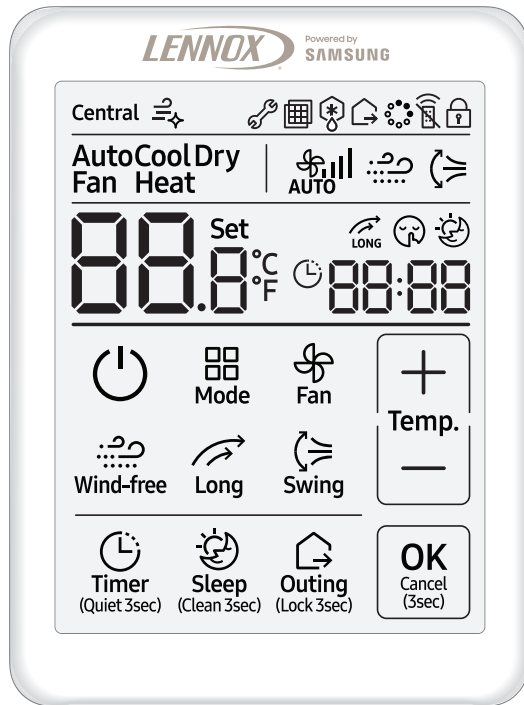

TOUCHSCREEN WIRED CONTROLLER (VSTAT02P-1)

NOTE - Features available depend on the type of indoor unit.

Features

- Backlight
- Built-in infrared receiver to allow control of indoor unit wirelessly with a wireless controller
- Indoor unit operation ON/OFF, operation mode, set temperature, louver position (cassette, ceiling, wall units), calm air, long reach, and fan speed settings
- Error display
- Filter replacement alarm display and reset
- All button lock (option)
- Partial controller button lock (ON/OFF, temperature setting, fan speed, timer function, louver swing, sleep function, quiet function, outing function, and operation mode buttons)
- Upper and lower temperature setting restriction
- Heat, cool, dry, fan, and auto mode skip options (skips specified mode on wired controller)
- Restrict wireless controller signal (optional)
- Single event timer function (ON/OFF control, 30 minutes – 24 hours timer setting options)
- System/indoor unit function and operation indication (defrost, error, restricted controller, central control, and PM filter status)
- Service mode for connected indoor unit operation monitoring, addressing, and setup
- Can be used to specify "Mode Master" while connected to a single indoor unit when used with heat pump systems to control system mode (heating or cooling)

- Outing function to keep a minimum heating (61 to 72°F) and cooling (77 to 86°F) temperature while away
- When Outing mode is activated, the unit will operate at the specified Outing temperature. If indoor temperature is 9°F different from desired Outing temperature, the indoor unit will turn on
- If indoor temperature is the same as desired Outing temperature, the indoor unit will turn off automatically
- This is repeated depending on indoor temperature for 12 hours. After 12 hours, Outing mode is released/ canceled
- Supports enabling indoor unit AP mode for connecting integral indoor unit Wi-Fi adapter to SmartThings, and turning indoor unit Wi-Fi connection ON/ OFF, indoor unit Wi-Fi information reset, and Wi-Fi adapter reset

SPECIFICATIONS

Power Supply	12VDC
Power consumption	1.5W
Operating temperature range	32 to 104°F
Operating humidity range	30 to 90% RH
Communication	2-wire PLC
Maximum wire length	328 ft. (100 m)
Dimensions (H x W x D)	4-3/4 x 3-5/8 x 3/4 in. (121 x 92 x 19 mm)

TOUCHSCREEN WIRED CONTROLLER FUNCTIONS (VSTAT02P-1)

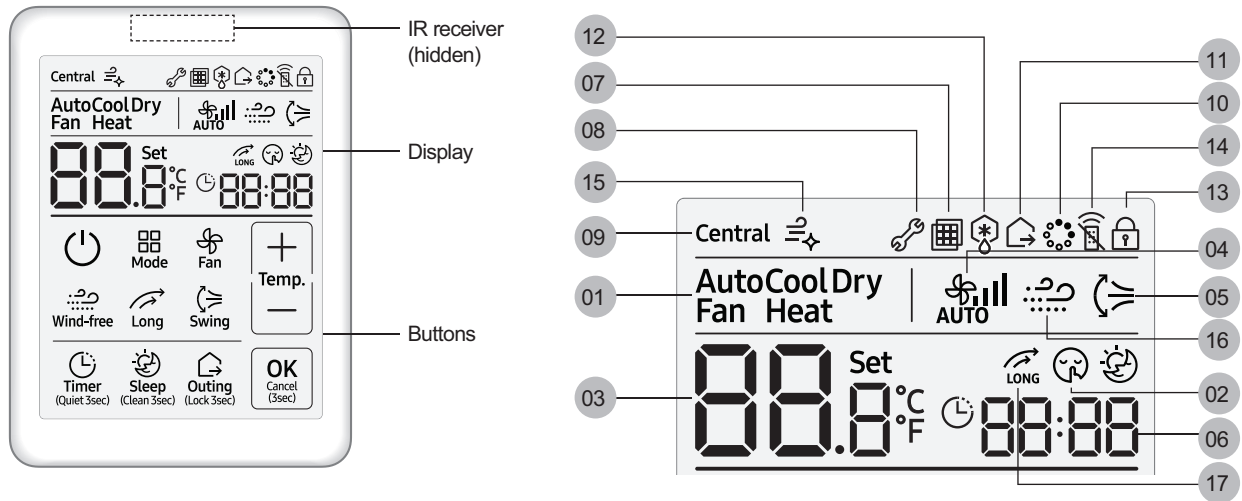

NOTE - Functions available depend on the type of indoor unit.

Number	Description
1	Displays system mode of operation
2	Displays quiet operation
3	Displays Indoor temperature/Set temperature
4	Displays indoor unit fan speed
5	Displays air swing (Up/Down)
6	Displays ON/OFF time (scheduled time)
7	Displays filter cleaning (filter cleaning period)
8	Displays error
9	Displays centralized control
10	Displays S-Plasma Ion operation
11	Displays outing (away) mode
12	Displays defrost operation
13	Displays partial locking/all locking/invalid operation
14	Displays IR receiver for wireless remote controller (Default - off)
15	Displays Clean operation
16	Displays Calm Air (Wind-Free) Cooling operation
17	Displays Long reach operation

TOUCHSCREEN WIRED CONTROLLER FUNCTIONS (VSTAT02P-1)

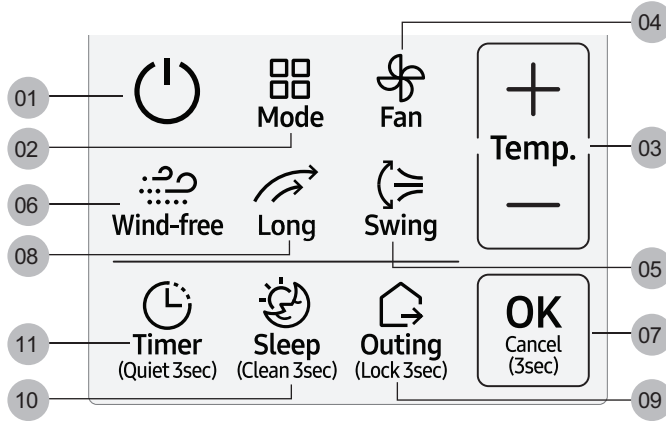
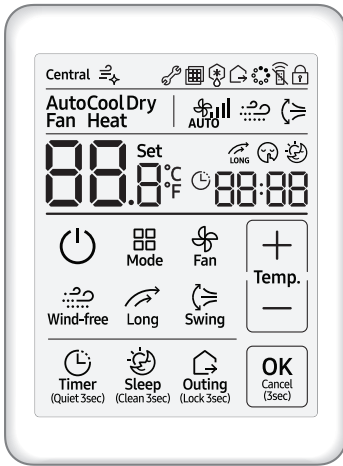

NOTE - Functions available depend on the type of indoor unit.

Number	Description	
1	Operation on/off button	Turn the system power on/off
2	Mode button	Select a desired system operation
3	Temperature setting button	Set a desired temperature and adjust the time
4	Fan speed button	Change the indoor unit fan speed
5	Air swing button	Select the air flow direction of the indoor unit
6	Calm Air (Wind-Free) button	Select Calm Air (Wind-Free) Cooling operation
7	OK/Cancel button	Confirm or cancel (by pressing and holding the button for 3 seconds)
8	Long button	Select Long reach function
9	Outing/Lock button	Select outing operation for the indoor unit/Lock the wired remote controller
10	Sleep/Clean button	Select Sleep/Clean operation for the indoor unit
11	Timer/Quiet button	Select the timer function/quiet operation for the indoor unit

REMOTE CONTROLLERS - OPTIONAL



PROGRAMMABLE WIRED CONTROLLER (VSTAT04P-1)

NOTE - Features available depend on the type of indoor unit.

Indoor Unit Control

- Air handler operation ON/OFF
- Air handler operation mode, set temperature, air flow direction, fan speed
- Discharge air temperature setting (for supported indoor unit models)
- Filter replacement alarm display and reset
- Time synchronization with supported Samsung central controllers
- Dual Set Temperature (for supported indoor unit models)
- Advanced HP auto changeover control and configuration
- Quiet and sleep modes
- Freeze Wash activation
- Error display (up to 10 error codes with descriptions)
- Supports enabling indoor unit AP mode for connecting integral indoor unit
 - Wi-Fi adapter to SmartThings, and turning indoor unit Wi-Fi connection ON/OFF, indoor unit Wi-Fi information reset, and Wi-Fi adapter reset

Energy Saving Operation

- Upper/lower temperature restriction setting
- Occupied/unoccupied settings
- Setback function
- Energy saving operation mode
- Energy consumption monitoring and daily, weekly, monthly, and yearly energy consumption trending (for supported systems)
- Maximum current control (for supported outdoor unit models)

Weekly Operating Schedule

- Weekly operating schedule
- Set desired A/C operation mode, setting temperature and fan speed to operate based on weekly schedules
- Schedule exception day option

Additional Features

- Emergency heat/auxiliary heat operation indication on display (for supported outdoor unit models)
- Color display screen
- Different button permission levels
- Supports multiple languages
- Partial button lock options (operation on/off, heat mode, cool mode, fan mode, dry mode, auto mode, set temperature, fan speed, scheduling, calm air, Long-wind, quiet mode, and sleep mode buttons can be locked individually)
- Daylight savings clock advance option
- Temperature limit setting option
- Real-time clock function
- Built-in IR receiver for indoor unit control using a wireless controller and integral room temperature sensor
- Indoor unit operation state display
- Indoor unit service mode support
- Micro SD card slot for simple firmware updating
- Independent louver control for cassette units
- Airflow direction control for 360° Cassette indoor units
- Adjustable heating temperature compensation values
- Calm Air (Wind Free) Control
- MDS (Motion Detection Sensor) Indirect/Direct Control (for supported indoor units, accessory may be required)
- Long Reach Function (for supported indoor unit models)
- Automatic air volume enable and status viewing (for supported indoor unit models)

SPECIFICATIONS

Power supply	12VDC
Power consumption	2W
Operating temperature range	32 to 104°F
Operating humidity range	30 to 90% RH
Communication	2-wire PLC
Maximum wire length	328 ft. (100 m)
Dimensions (H x W x D)	4-3/4 x 4-3/4 x 3/4 in. (121 x 121 x 19 mm)

OPTIONAL CONTROL ACCESSORIES



Thermostat Adaptor

NOTE - Features available depend on the type of indoor unit.

Features

- Allows control of Lennox mini-split systems with a standard 24VAC thermostat
- One adaptor per indoor unit connected to the F3-F4 communication line
- Basic control:
 - Power: ON/OFF
 - Mode: Heat, Cool, Fan (auto, low, medium, high)
- Supports 1 or 2 stages cooling inputs, 1 or 2 stages heating inputs
- Can be configured to operate the indoor unit as primary heating source, secondary heating source, or cooling only with heat from an external source only
- External contact input to disable the unit when contact is opened

Option Settings

- Single fan input or 3 speed input for Low, Medium, and High
- Heat staging options:
 - Stage 1 and 2: Indoor unit operates in heat mode
 - Stage 1: Indoor unit operates in fan mode
Stage 2: Indoor unit operates in heat mode
 - Stage 1: Indoor unit OFF
Stage 2: Indoor indoor unit operates in heat mode
 - Stage 1: Indoor unit OFF. Stage 2: Indoor unit OFF (heating is only provided by external source that does not require fan operation from the Indoor unit)
- “Emergency Heat” output enable
- Stage 1 and stage 2 heating and cooling set temperature

SPECIFICATIONS

Power Supply	24VAC (field supplied transformer required)
Installation temperature range	32 to 122°F
Installation humidity range	10 to 85% RH
Maximum wire length	328 ft. (100 m)
Dimensions (H x W x D)	5-1/8 x 5 x 1-1/2 in. (130 x 127 x 38 mm)

SPECIFICATIONS

Model		MMD012M6	MMD018M6	MMD024M6
Zone Type		Multi	Multi	Multi
Tons		1	1.5	2
Line voltage data (Volts-Phase-Hz)		208/230-1-60	208/230-1-60	208/230-1-60
Connections	Liquid (flare) - in.	1/4	1/4	1/4
	Gas (flare) - in.	3/8	1/2	5/8
	Condensate drain FPT - in.	3/4	3/4	3/4
Fan	Air Volume - cfm (High/Medium/Low) - Cooling	375 / 286 / 244	600 / 530 / 495	760 / 636 / 548
	Air Volume - cfm (High/Medium/Low) - Heating	375 / 286 / 244	600 / 530 / 495	760 / 636 / 548
	External Static Pressure min./std./max.) - in. w.g	0.10 / 0.39 / 0.51	0.10 / 0.58 / 0.59	0.10 / 0.58 / 0.59
	Output (W)	153	153	153
Filter		Washable	Washable	Washable
Sound Data (dBA)	High/Medium/Low	36 / 34 / 32	40 / 37 / 34	43 / 40 / 37
Shipping Data	Net	95	100	100
	Shipping	105	110	110

OPTIONAL ACCESSORIES - ORDER SEPARATELY

Description	Order Number	Size		
		012	018	024
INDOOR UNIT				
Diversitech Mini-Split Pump - 4 US gallons per hour, 20 ft. lift - 230V	Y7949	•	•	•
Condensate Pumps with Reservoir ClearVue Mini™ - 8 US gallons per hour, 35 ft. lift - 120-240V	Y5170	•	•	•
Blue Diamond® Condensate Pumps with Reservoir	MicroBlue® - 1.3 US gallons per hour, 6 ft. lift - 110-230V	14T74	•	•
	MaxiBlue® - 3.7 US gallons per hour, 16.5 ft. lift - 208/230V	14T69	•	•
	MultiTank Kit - 0.4 US gallon	14T75	•	•
	Sensor Cable Extension - 16 ft.	14T76	•	•
Little Giant Condensate Pump Kit with Reservoir Mini-Split Pump Kit - 2.5 US gallons per hour, 3 ft. lift - 100-240V (includes pump, reservoir, multi-size hose drain adaptor, 7 ft. detachable power cord, pump enclosure/cover, line set cover and mounting trim brackets)	Y8794	•	•	•
Condensate Drain Line 5/8 in. ID - 160 ft. - white	Y3401	•	•	•
A/C Easy Tee® Condensate Cleanout	Y7947	•	•	•
Downflow Conversion Kit VDK-1W	30L84	•	•	•
Horizontal Support Frame Kit	56J18	•	•	•
Side Return Unit Stand (Upflow Only)	45K32	•	•	•
Wall Hanging Bracket Kit (Upflow Only)	45K30	•	•	•
CONTROLS				
Wireless Remote Controller VSTAT01P-1	37Y73	•	•	•
Touchscreen Wired Controller VSTAT02P-1	37P79	•	•	•
Programmable Wired Controller VSTAT04P-1	37Y74	•	•	•
Thermostat Adaptor (24V) VSTAT09P-1	37Y96	•	•	•

ELECTRIC HEAT DATA

Usage	Size	Electric Heat Model Number	¹ Input				Blower Motor Full Load Amps		² Minimum Circuit Ampacity		³ Maximum Overcurrent Protection	
			Btuh		kW		208V	230V	208V	230V	208V	230V
			208V	230V	208V	230V						
MMD012M6	3 kW	V1EHK01-1P (38V02)	7,700	9,400	2.25	2.76	0.59	0.65	14.27	15.78	15	20
MMD018M6	3 kW	V1EHK01-1P (38V02)	7,700	9,400	2.25	2.76	1.16	1.28	14.99	16.58	15	20
	5 kW	V1EHK02-1P (38V03)	12,800	15,700	3.76	4.59	1.16	1.28	24.02	26.56	25	30
MMD024M6	3 kW	V1EHK01-1P (38V02)	7,700	9,400	2.25	2.76	1.70	1.88	15.66	17.32	20	20
	5 kW	V1EHK02-1P (38V03)	12,800	15,700	3.76	4.59	1.70	1.88	24.69	27.30	25	30

¹ Electric heater capacity only - does not include additional blower motor heat capacity.

² Refer to National or Canadian Electrical Code manual to determine wire, fuse and disconnect size requirements. Use wires suitable for at least 167°F.

³ HACR type breaker or fuse.

NOTE - Optional electric heat cannot be used with Downflow Conversion Kit.

INSTALLATION CLEARANCES

Top	0 inch (0 mm)
Back	0 inch (0 mm)
Sides	0 inch (0 mm)
Supply Plenum and Duct (With Electric Heat)	1 inch (25 mm)
Floor	0 inch (0 mm)
¹ Front (Alcove)	30 inches (762 mm)
¹ Front (Closet)	6 inches (152 mm)

¹ Allow 30 inches (762 mm) for servicing.

BLOWER DATA

MMD012M6

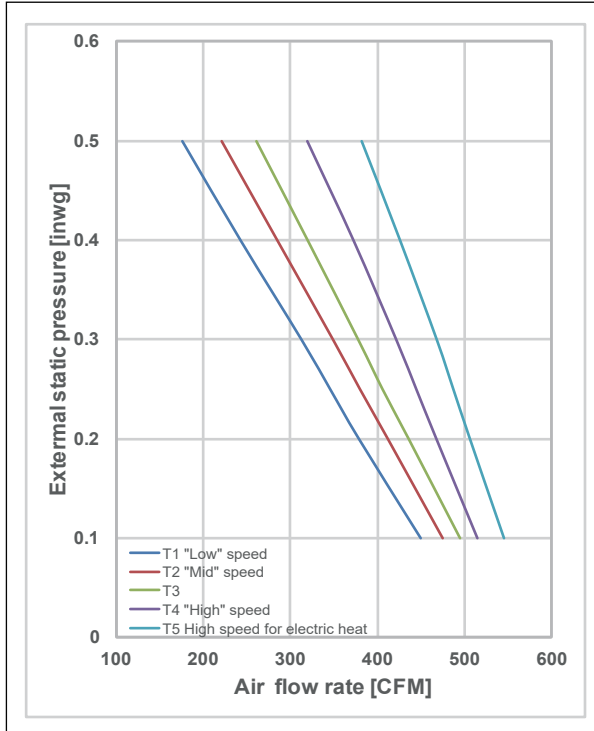

MMD018M6

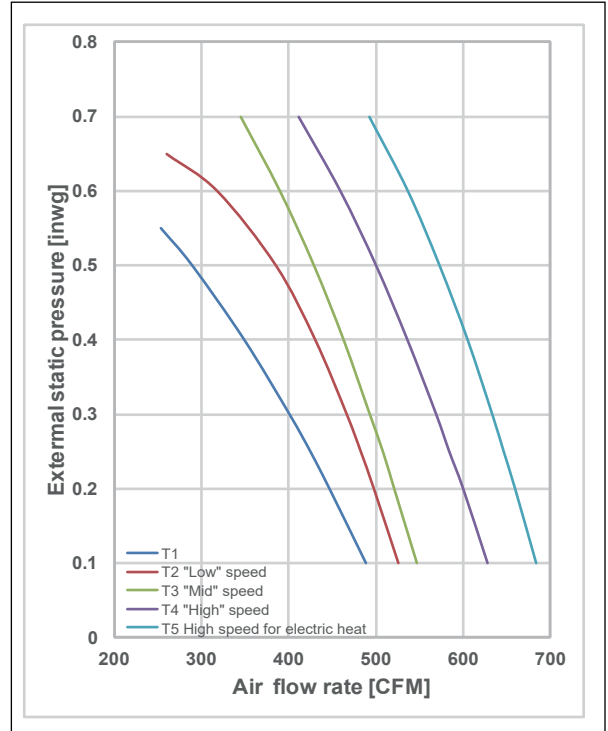

MMD024M6

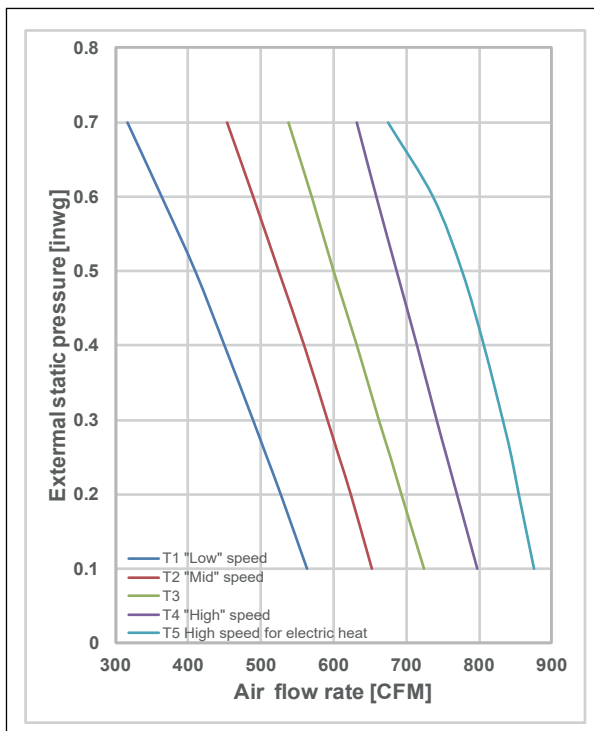

DIMENSIONS

MMD012M6 | MMD018M6 | MMD024M6

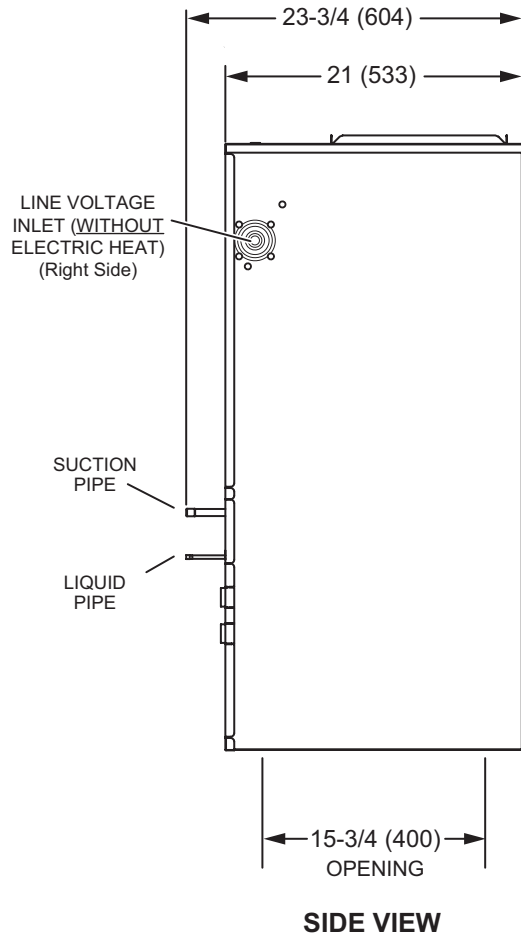
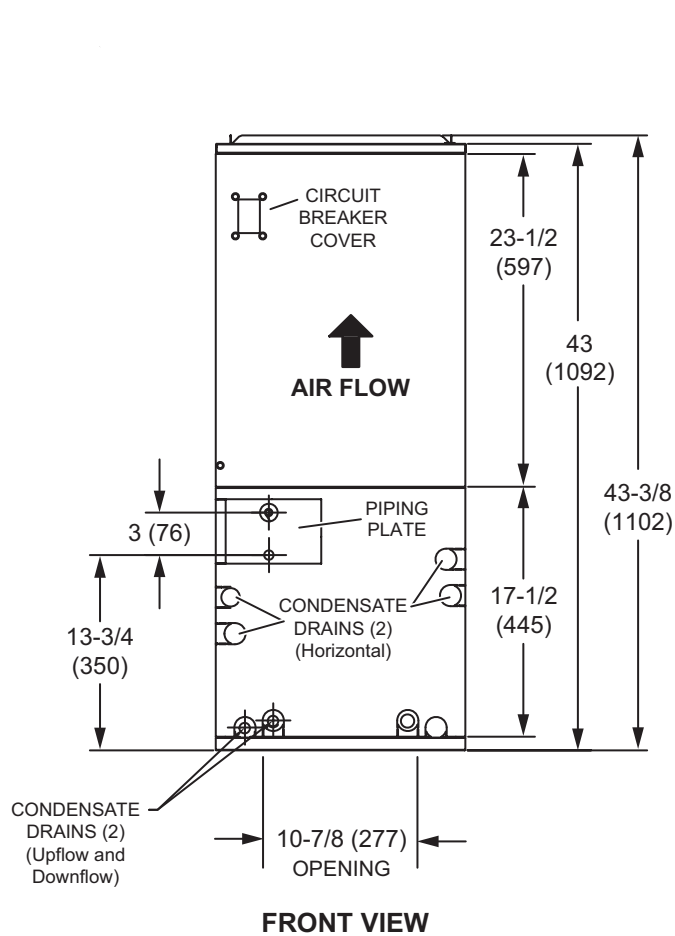
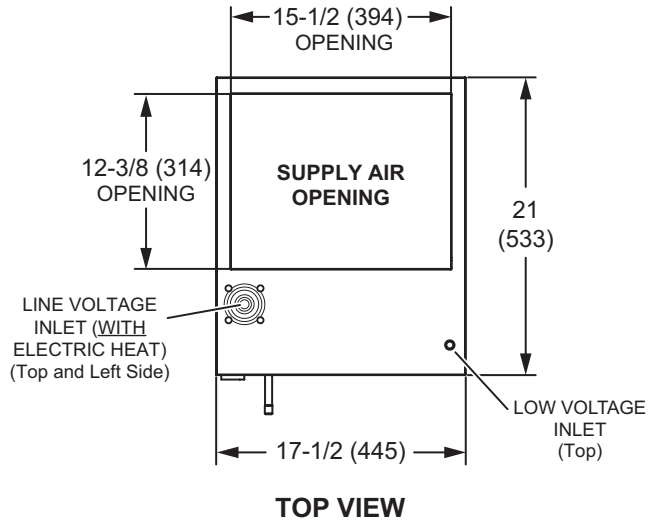

REVISIONS

Sections	Description of Change
Optional Accessories	Electric Heat is now approved for downflow applications.



Visit us at www.Lennox.com

For the latest technical information, www.LennoxPros.com

Contact us at 1-800-9-LENNOX

NOTE - Due to Lennox' ongoing commitment to quality, Specifications, Ratings and Dimensions subject to change without notice and without incurring liability. Improper installation, adjustment, alteration, service or maintenance can cause property damage or personal injury. Installation and service must be performed by a qualified installer and servicing agency.

©2026 Lennox Industries, Inc.