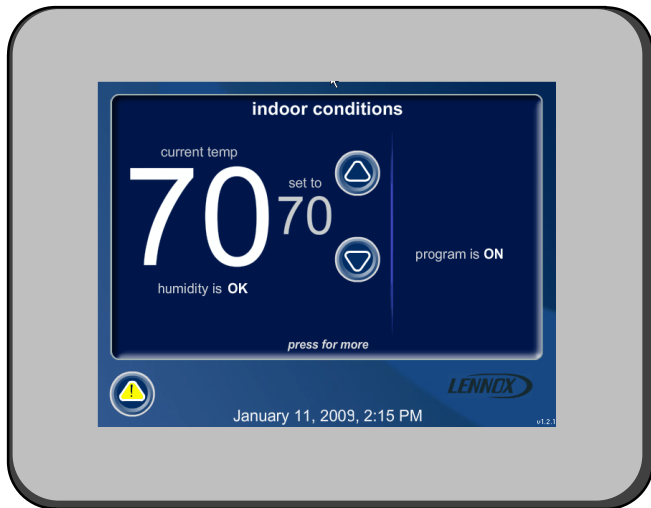




©2009 Lennox Industries Inc.  
Dallas, Texas, USA



# INSTALLER'S SYSTEM SETUP GUIDE

## icomfort™ Thermostat

Touch Screen Programmable Communicating Thermostat

CONTROLS  
506052-01  
11/09

TP Technical  
Publications  
Litho U.S.A.

### Shipping and Packing List<sup>1</sup>

- 1 - icomfort™ Touch Screen Communicating, 7-day Programmable Thermostat
- 6 - Mounting Screws
- 6 - Wall Anchors
- 1 each - Installation Quick-Start Guide, Installer's System Setup Guide, Homeowner's Manual, Warranty card, Warranty Audit tag



## Table of Contents

icomfort™ Thermostat Terms and Acronyms .....	3
icomfort™ Technical Description .....	4
icomfort™ Thermostat Features .....	5
Installing icomfort™ Thermostat .....	5
Installer setup .....	6
System settings .....	7
Setting time and date .....	8
Add/remove/modify non-communicating devices .....	9
Modify communicating device settings .....	10
Indoor air quality controls .....	12
Tests .....	14
Diagnostics .....	17
Alerts .....	18
Access installer program from User Home screen .....	22
Reconfiguring a system .....	23
Editable parameters table (user and Installer) .....	25
Alarm Codes and Descriptions .....	31
Wiring Diagrams .....	36



## WARNING

**Always turn off power at the main power source by switching the circuit breaker to the OFF position before installing or removing this thermostat.**

**All wiring must conform to local and national building and electrical codes and ordinances.**

**Do not switch system to cool if the outdoor temperature is below 45°F (7°C). This can damage the cooling system.**



## CAUTION

**This is a 24VAC low-voltage thermostat. Do not install on voltages higher than 30VAC.**

**Do not short (jumper) across terminals on the gas valve or at the system control to test installation. This will damage the thermostat and void the warranty.**



## IMPORTANT

**Read this manual before programming this thermostat.**

**Use this thermostat only as described in this manual.**

## icomfort™ Thermostat Terms and Acronyms

**Subnet Controller (SC):** (part of the communicating thermostat) Local device that controls the system.

**Subnet:** A part of the communication network that contains devices to control one functional HVAC system.

**RSBus** - Residential Serial Bus - the means for transmitting data within the communicating system.

**Controller Area Network Protocol:** Rules for networking, for transmission and receipt of information between communicating systems.

**Baud Rate:** Maximum speed of BUS 40K baud.

**Byte:** 8 bits of information transmitted on the RSBUS.

**Integrated Furnace Control (IFC):** Communicating control for furnace. IFC controls ignition, CAI, blower, and monitors all safety features in the unit.

**Air Handler Control (AHC):** Communicating control for air handler units. AHC controls operation of blower, heat strips, and monitors all safety features in the unit.

**HP Control (Defrost Control) (UC):** Communicating defrost control. UC controls low and high speed compressor operation, defrost opera-

tions, fan motor, and reversing valve and monitors all safety features in the unit.

**AC Control:** Communicating air conditioning control. AC controls low and high speed compressor operation, fan motor operation, and all safety monitors in the unit.

**Discharge Air Sensor (DAS):** Communicating discharge air sensor. Provides discharge air temperature to Bus, UI, and IFC for proper operation of equipment.

**R:** 24V power

**C:** 24V common

**i+:** + data information connection

**i-:** - data information connection

**Configuration:** Function that accrues during setup of system to identify other communicating devices. Configuration is also used in setup of a variable capacity furnace to properly set furnace parameters.

**Memory Fault Recall:** Method of checking for errors

**Firmware:** Software stored on a memory chip instead of being part of a program

**Software:** Programming and applications for computer

## icomfort™ Technical Description

The 24VAC icomfort™ thermostat stores system parameters and settings in a nonvolatile memory (i.e., it retains data when electrical power fails or is turned off). The thermostat (see figure 1) also:

- includes on-board help screens,
- supports heat pumps or non-heat pump units, with up to 4 stage heat / 2 stage compressor operation. (2 stages of heat pump heating and 2 stages of auxiliary backup heat are provided. Also, 2 stages of emergency heat are provided),
- supports Indoor Air Quality with time-based notification of consumables including media filters, UVC bulbs, humidifier pads, and PureAir™ catalyst service / replacement,
- supports variable capacity / multistage heat/cool, universal compatibility (gas/electric/heat pump/ac), and is dual fuel capable with two balance points.

### Important

Always use correct software version as recommended for replacement configuration (discovery).

Connections to non communication outdoor units and all accessories is described in the Quick-Start Installation guide. (Wiring diagrams are also shown beginning on Page 36.)

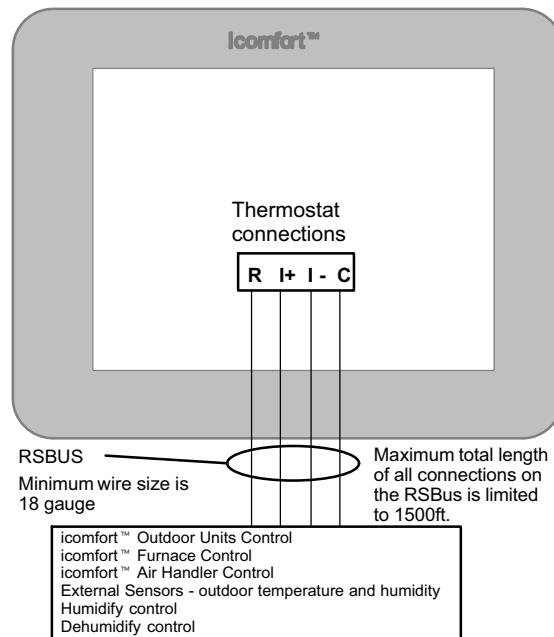


Figure 1. icomfort thermostat system

## icomfort™ Thermostat Features

### Thermostat Type

Electronic communicating, color display touch screen, 7-day programmable.

### Supports

- Humidification Measurement and Control,
- Dew Point Adjustment Control,
- Dehumidification Measurement and Control,
- Humiditro® Enhanced Dehumidification Accessory (EDA),
- Multi-stage HVAC Systems,
- Equipment Maintenance Reminders.
- On-board Help Screens.

The icomfort™ thermostat's autochangeover mode permits control of heating, cooling, humidification, and dehumidification without user involvement.

### Outdoor Temperature Sensor

Communicating outdoor units contain a built in outdoor temperature sensor.

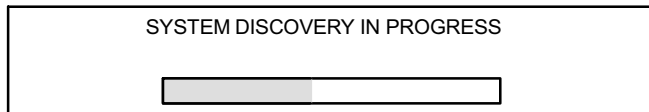
## Installing icomfort™ thermostat

Refer to the *Quick Start Guide* for all the information about installing the thermostat to a wall and for wiring diagrams for connecting the thermostat to the system using one of a number of possible configurations. (Wiring diagrams are also shown beginning on Page 36.)

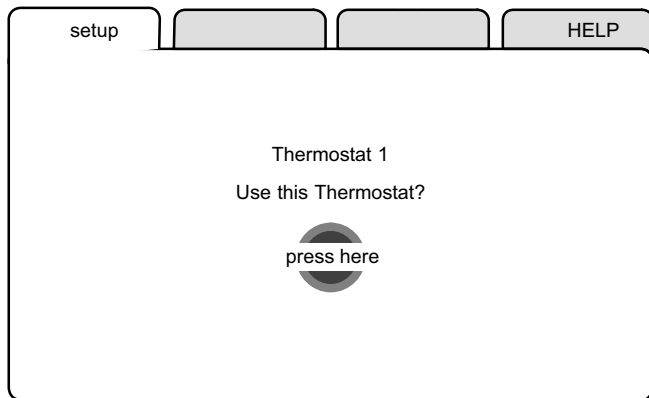
After all the wiring is in place, apply power to the system. 24VAC will begin to power up the thermostat.

Continue with the **Installer setup** that follows.

After power is applied to the thermostat for the first time, the processor checks the system for installed communicating devices, the "System discovery" screen (figure 2) is displayed on the thermostat; followed by the "Use this thermostat" screen (figure 3). Press **press here** to continue.

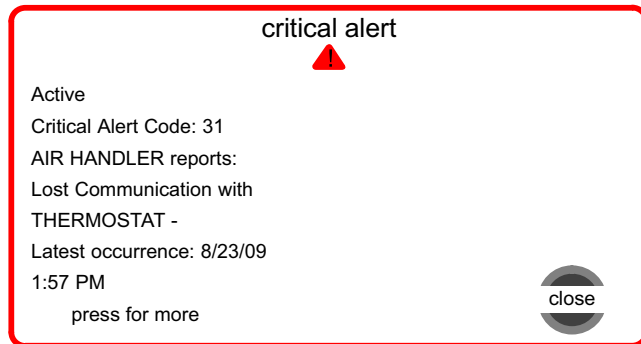


**Figure 2. System discovery**



**Figure 3. Use this thermostat screen**

During the setup process, alerts may pop open to inform the installer some item of information that affects the setup (figure 4). Tend to any such alerts prior to continuing setup.



**Figure 4. Alert window**

“System settings“ (figure 5) appear first. As you use the up/down arrows to scroll through the settings, the right hand side will show the current value, for example, **Current Value: (35%)** shows the current setting of the **Circulate Fan ON time**.

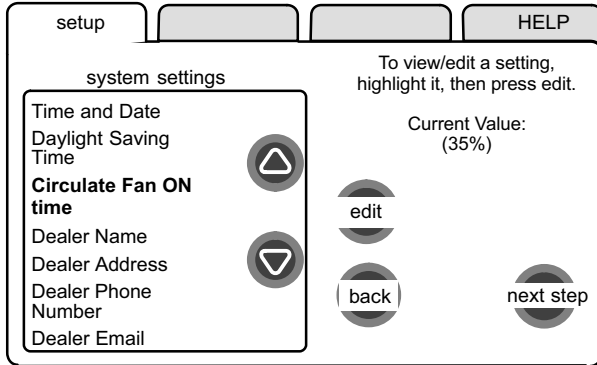


Figure 5. System settings

The following shows the range/condition and defaults for the settings.

system setting	range/condition	default	use
Time and Date	see Page 8		
Daylight Saving Time	Enabled/Disabled	Enabled	 
Circulate Fan ON Time	15 to 45	35%	
Dealer Name	(alpha-numeric characters)	Lennox	use type writer to change
Dealer Address		—	
Dealer Phone Number		1-800-9-LENNOX	
Dealer Email		—	
Dealer Website		www.lennox.com	

If you want to modify a setting, use one of the tools shown in figure 6. (Make **time and date** as described on Page 8.) After changes have been made, use **save** to store the changed data or **cancel** to exit the screen and return to the list of settings.

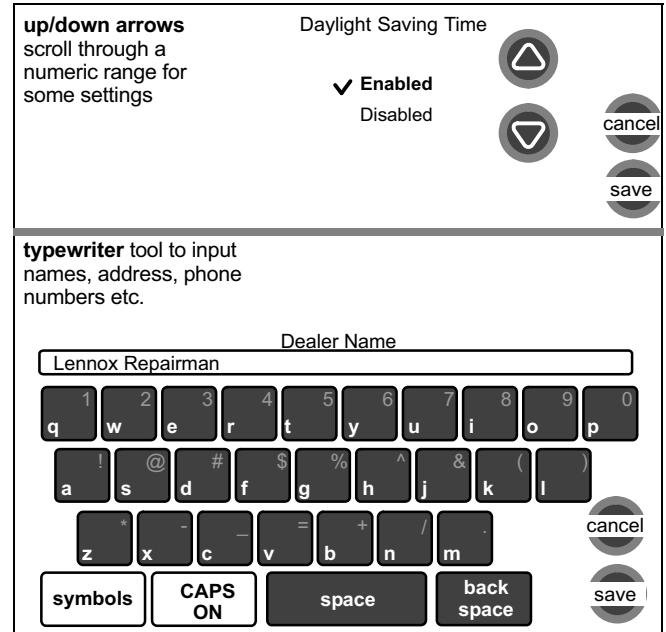
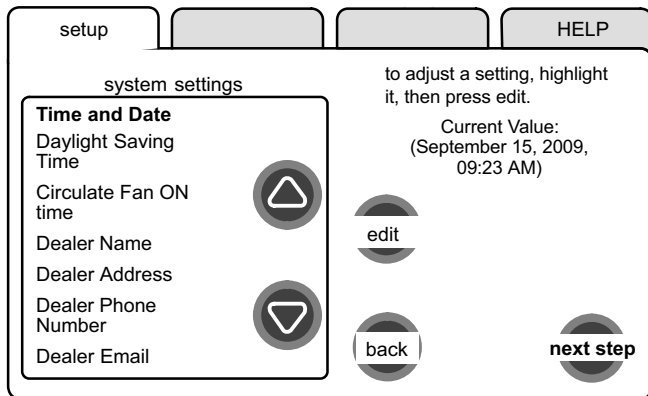


Figure 6. Settings change tools

### Setting time and date

Use the arrows to select **Time and Date**; press **edit** (see figure 7). Press **next** to proceed to the “Set current time and date” screen (figure 8).

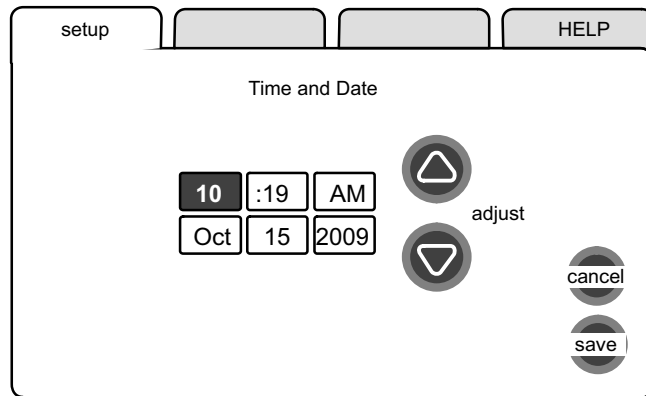


**Figure 7. View/edit time and date**

When the “Time and Date” screen appears, enter the correct date as follows:

- Press one of the time and date boxes - the text will change to white type in a dark box (for example, press the “10” box in figure 8).
- Press the **up/down arrows** to change the data.

- Press other boxes and adjust with the arrows for all time and date information. When the date and time is correct, press **save** to save settings and return to previous settings screen.



**Figure 8. Set current time and date**

*NOTE - After setting the time and date, if you don't need to add any non-communicating devices, you may wish to accept the default system parameters and skip forward to “tests”. To do so, repeatedly press **next step** on each screen until you get to the **tests** screen. From there, you can check the systems operation. Thereafter, should you need to change a communicating device parameter, access those settings by pressing the **equipment** tab in the installer section.*

### Add/remove/modify non-communicating devices

From this screen (figure 9), use the **yes** button to access a list of non-communicating devices for installing or removing. A list similar to that shown in figure 10 will appear.

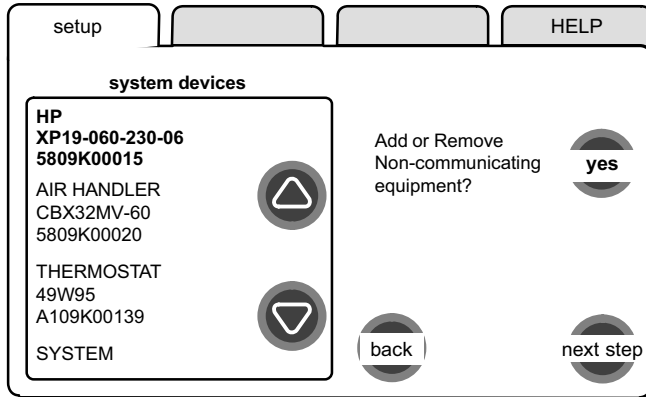


Figure 9. Add/remove/modify non-communicating devices

**Humidification / Dehumidification Control Modes** depend on a humidifier and/or dehumidifier being added to the system. Therefore, you must press **yes** on the button near "Add or Remove Non-communicating equipment?" Also, in order for the user's display to show these controls, the system controls must be set. See Page 12 for more information.

Use the up/down arrows (see figure 10) to select a setting. The right hand side of the screen indicates what is currently selected, for example, **Current Value: (Not Installed)**; press **edit** if you want to modify that setting.

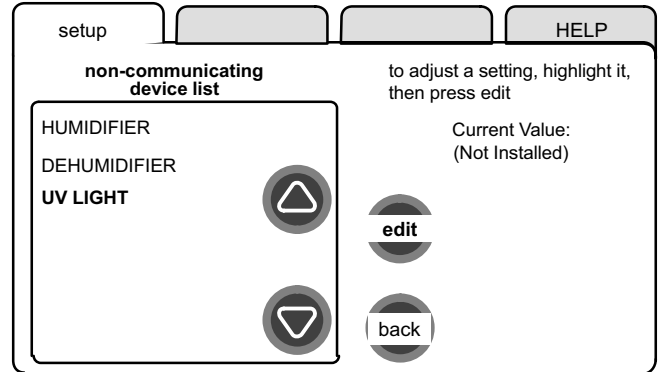


Figure 10. Installing UV Light

A typical Installed status screen (Figure 11) shows if the device is not installed or type of equipment installed. Use the arrows to change and use **save** to save the change. (**Cancel** goes back to previous screen.)

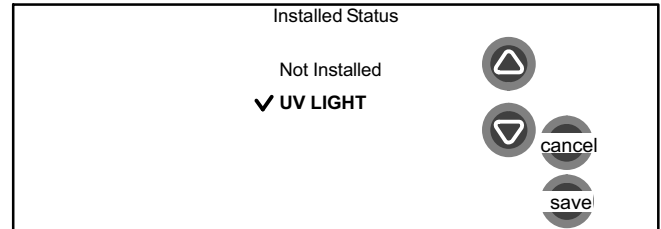


Figure 11. Typical non-communicating device edit screen

### Modify communicating device settings

Use this screen (figure 12) to access communicating devices' settings. Use **back** to return to the previous screen or **next step** to go on.

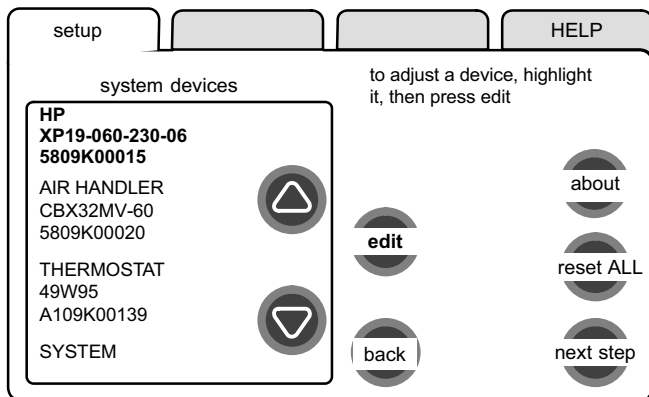


Figure 12. Accessing communicating device settings

With one of the devices highlighted, press **about**, then use arrow keys to see a list of data about the selected device. If you select **reset ALL**, and then **confirm**, ALL devices will be reset to their factory settings. (You would see a screen similar to figure 14.)

With one of the devices in figure 12 highlighted, press **edit** to go to that device's list of settings (see figure 13).

Use the up/down arrows to scroll through the device's settings and observe the right hand side of the screen (figure 13) to see the current setting, for example, **Current Value: (Off)**. Press **edit** if you want to modify that setting, or press **back** to return to the previous screen.

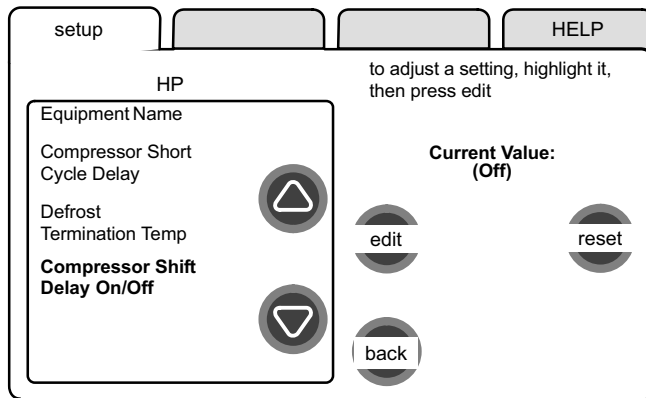
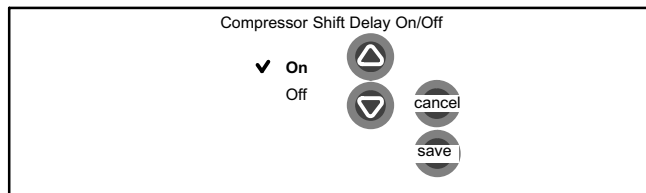


Figure 13. Modify communicating device settings

Settings available for the devices are dependant on the components you have. Shown below is an example of changing the compressor shift delay on. After using the arrows to select **On**, press **save** to save the changes and return to the previous screen.



If you select **reset** and then **confirm**, the highlighted device will be reset to its factory setting. You would see a screen similar to figure 14, but referencing only the selected device.

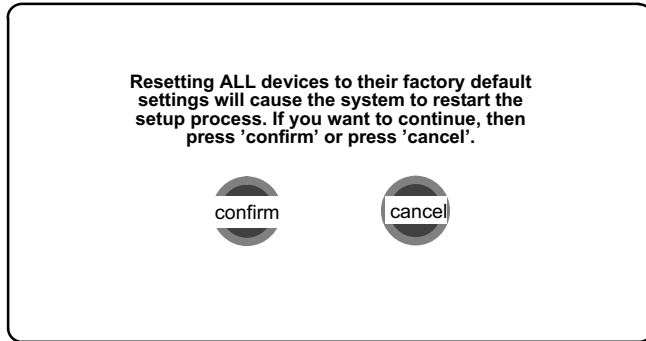


Figure 14. Reset device confirmation note

After a reset, the device which had its settings reset to default will display in the system devices screen in red type. You will be required to highlight the red-type device(s) and use **edit** (see figure 12) to change, or at least view the changed settings of the red-type devices .

HP  
 XP19-060-230-06  
 5809K00015  
 AIR HANDLER  
 CBX32MV-60  
 5809K00020

In the **edit** mode, the feature list will show the selected device's changed features in red type. Use the up/down arrows to select each red-typed feature and press **edit**. Make changes to the settings using the *Edit tools* if desired, or at least, press **save** in each feature screen. Upon saving, the previous screen will display and the type will again be black. Press **back** to return the *Modify communicating device settings* screen.

Equipment Name  
 Electric Heating  
 Airflow  
 Low Cooling  
 Airflow  
 Low Cooling  
 Airflow

At this point press **next step** to advance to the test controls.

### Indoor air quality controls

An example of installing **UV Light** is shown in figure 10, Page 9.

To turn on **humidification or dehumidification controls**, in addition to the setup described on Page 9, work from either the *setup* tab or the *equipment* tab to get to the adjustment screen (figure 15). Use the arrows to highlight the **SYSTEM** selection. Press **edit**.

A long list of features are listed on the right of the next screen (see figure 16). Use the arrows to locate **Humidification Control Mode** and/or **Dehumidification Control Mode**. Press **edit**.

Depending on the type of equipment installed, the lists of options may be different than those shown in figure 17. In order for either or both of these controls to display, the selected option must be other than "Display Only".

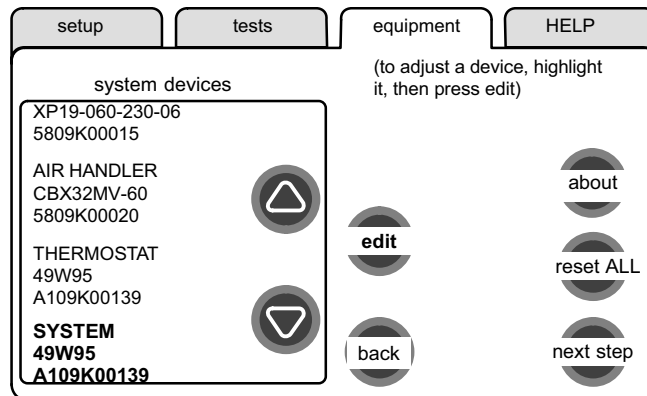


Figure 15. Accessing the SYSTEM adjustment screen

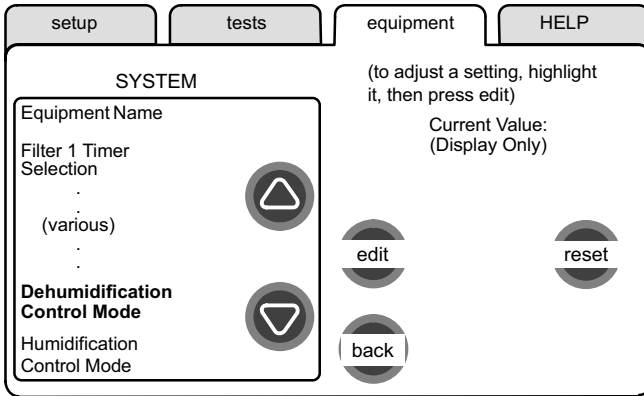


Figure 16. SYSTEM adjustment screen

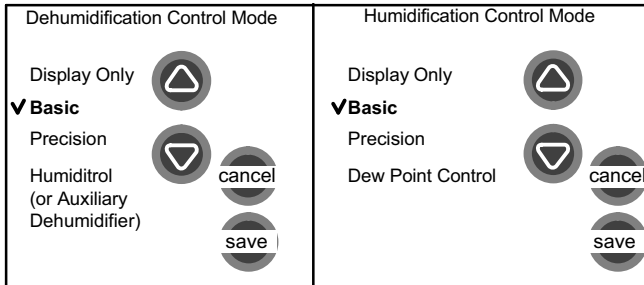


Figure 17. Selecting Dehumidification/Humidification mode

## HUMIDIFICATION modes

**BASIC & PRECISION**—these modes allow user control of RH between 15 and 45%. These conditions must be met for either mode to operate:

- humidification mode has been enabled, and
- the unit is in HEAT mode, and
- humidification demand exists (24V present at H), and
- **BASIC** mode also requires heat demand exists (Y for HP heat, or W for gas heat [W may be energized with G de-energized]).

**DEW POINT CONTROL**—Dew point adjustment mode will change the humidification setpoint based on the outdoor temperature and a user-defined dew point adjustment setting.

## DEHUMIDIFICATION modes

In **BASIC** mode, dehumidification occurs if these conditions are met and signals are present at specific terminals:

- dehumidification has been enabled on installer settings, and
- the unit is in COOL mode, and
- dehumidification demand exists (RH above setpoint), and
- cooling demand exists (Y1 energized).

In **PRECISION** mode, dehumidification occurs if all BASIC conditions are true, except cooling demand may or may not be present. Maximum overcool from cooling set point is 2°F.

**HUMIDITROL or AUX. DEHUMIDIFIER** mode requires:

- outdoor sensor must be installed and setup
- dehumidification has been enabled on installer settings, and
- the unit is in COOL mode, (or if in AUTO, at least one thermostat cooling call made prior to the dehumidification demand), and
- a dehumidification demand exists (RH above setpoint), and
- outdoor temp. below 95°F; indoor temp. above 65°F, and
- for **HUMIDITROL**, Humiditrol comfort adjust parameters as follows:  
**MAX** adj. - Indoor temp > 2°F above heating setpoint  
**MID** adj. - Indoor temp >  $\frac{\text{HEAT SETPOINT} + \text{COOL SETPOINT}}{2}$   
**MIN** adj. - Indoor temp > 2°F below cooling setpoint

The **tests** feature is not available until after **setup** has been completed once. After you press **next step** in the final **setup** screen, the “Select tests to run” screen (figure 18) appears.

If you re-select the **tests** tab from any other screen, a message to “press Start button below to begin system testing” appears; press **start**.

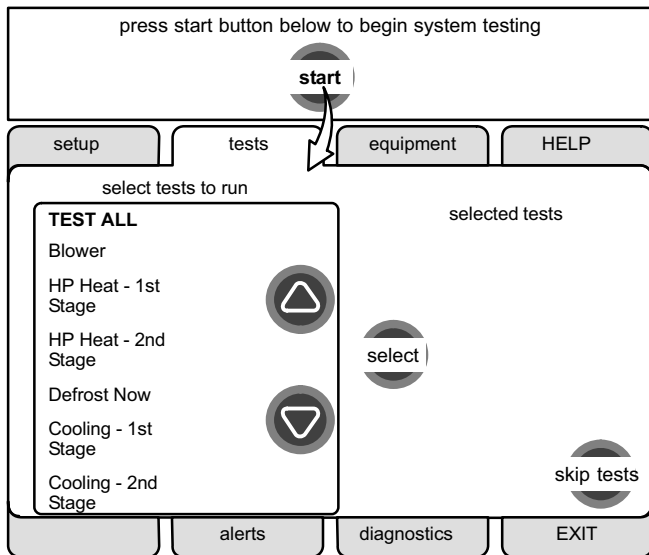


Figure 18. Select tests to run

When the **tests** screen opens, TEST ALL will be highlighted (but not yet selected). If you want to run TEST ALL, press **select**. Note your selection on the right side says “selected test TEST ALL”. Also, note there are now two buttons along the bottom labeled **remove** and **start**. Use **remove** to deselect a selected test.

If you prefer, run tests one-at-a-time using the arrows to highlight a desired test and then press **select**.

Press **start** to begin testing.

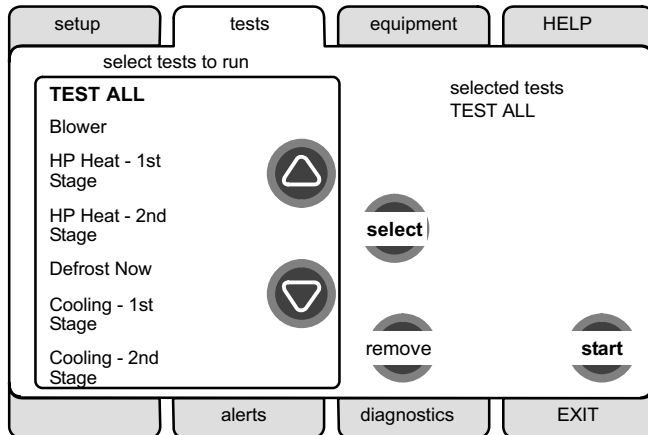
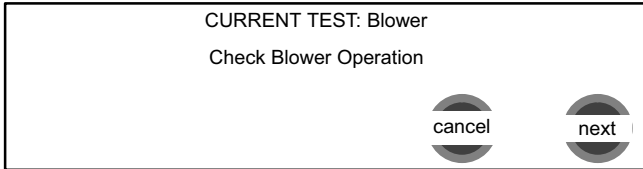


Figure 19. Start running tests

After the tests have been started, the screen will describe which test is running (see figure 20). After concluding that the results are the desired results for any test, press **next** (if using TEST ALL) to proceed to the next test or **done** (if running a single test).

**TEST ALL example**



**single test example**

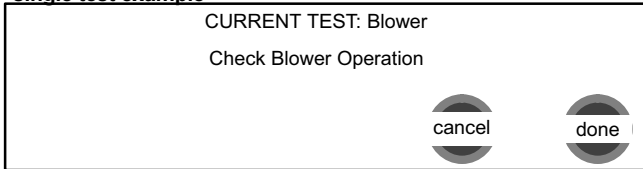


Figure 20. Typical tests results screens

After pressing **done**, the "Testing finished" screen will appear (see figure 21). At this point, use the **EXIT** tab (if you are finished with all setup), or use **diagnostics** tab (to analyze the system), or use **equipment** tab (if you wish to make any changes to device details).

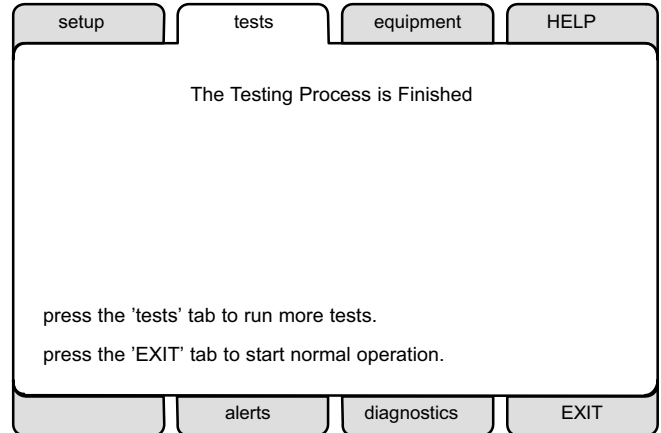
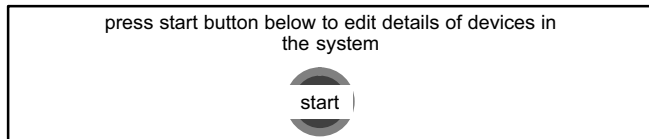


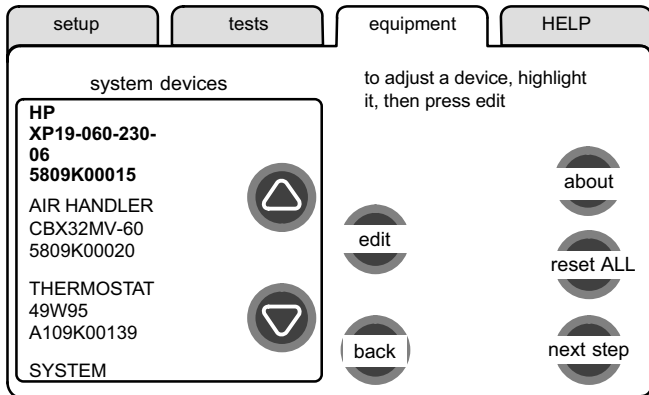
Figure 21. Testing finished screen

## Equipment - Page 1 of 1

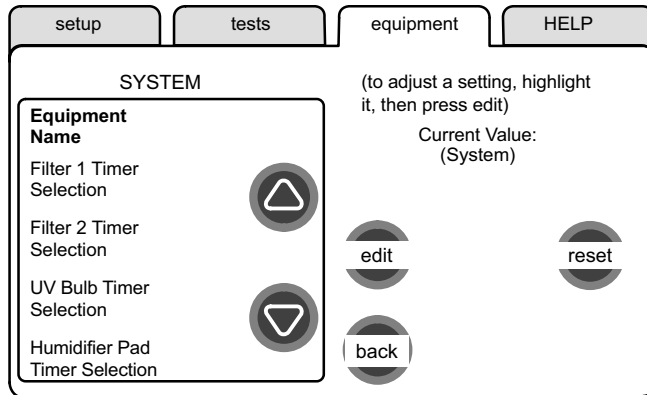
This feature allows the installer to edit details of devices in the system without having to re-run the setup program. The following appears after the equipment tab has been selected



Press **start**; the "Equipment details edit" screen (figure 22) will open. You may view information about or modify communicating devices as described earlier in the setup pages, beginning on page 10.



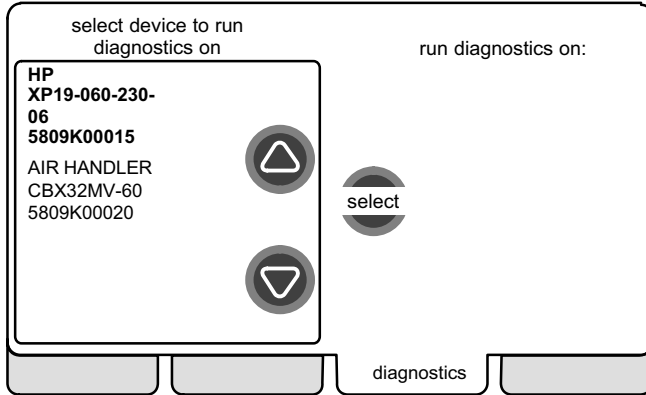
**Figure 22. Equipment details edit**



**Figure 23. Equipment details edit**

Table on Page 25 shows a list of Editable Parameters for the currently available devices designed to communicate in this system. Other devices and additional parameters may be added at a later date. Check the unit installation manuals (i.e. furnace, air handler, heat pump, ac unit) for current information and default parameters.

If you need to run diagnostics to analyze the system, press the **diagnostics** tab. The “Select device to run diagnostics” screen (figure 24) will open.

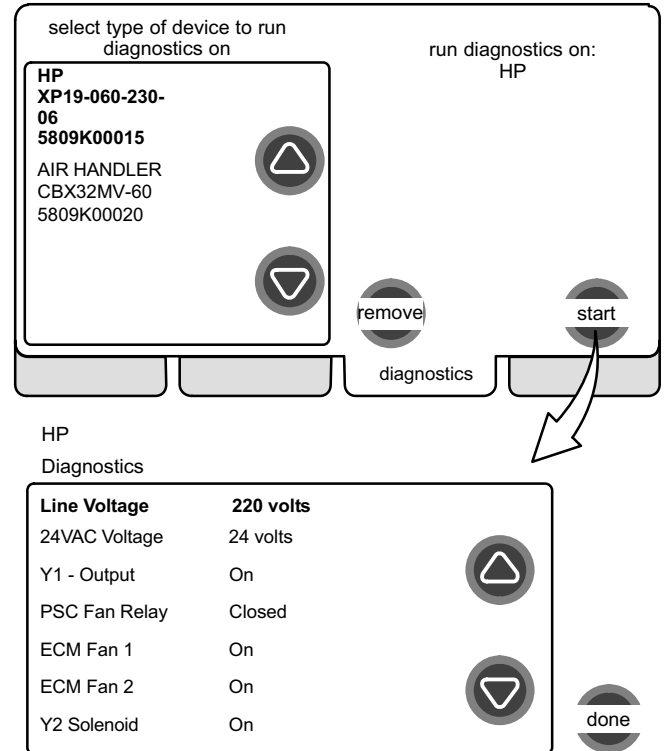


**Figure 24. Select device to run diagnostics**

Use the arrow buttons to scroll through the list of items found on the left of the screen. Then press **select**. The right side of the screen shows which item is selected (figure 25). Use **start** to begin the process. The screen will show “DIAGNOSTICS IN PROGRESS...” briefly, then change to show the list of values and conditions discovered.

Use the arrow buttons to scroll through the information and take note of any found to be out of operating range.

Press **done** when finished with the information and select another device to diagnose or use **EXIT** if finished.



**Figure 25. Running diagnostics**

## Alerts - Page 1 of 4

As described earlier on Page 6, alerts may pop up on the screen during setup. To view alerts otherwise, press the **alerts** tab. Up to 10 alerts are stored for recall by the technician.

The left side of the main alert screen shows a list of each communicating device discovered in the system and includes model and serial number information. The up/down arrows allow you to scroll through the list of discovered devices. The selected device is shown in bold lettering.

On the right side of the alert screen, press **view active alerts** to list all active alerts for either SYSTEM ALERTS (lists alerts from all communicating devices) or a selected device. If there are no alerts, the display will show "There are no new alerts that require service".

Press **view cleared alerts** to list previously active alerts that were cleared by the device or installer. Until at least one alert has been cleared by the device or the installer, the display will show "There are no new alerts that require service".

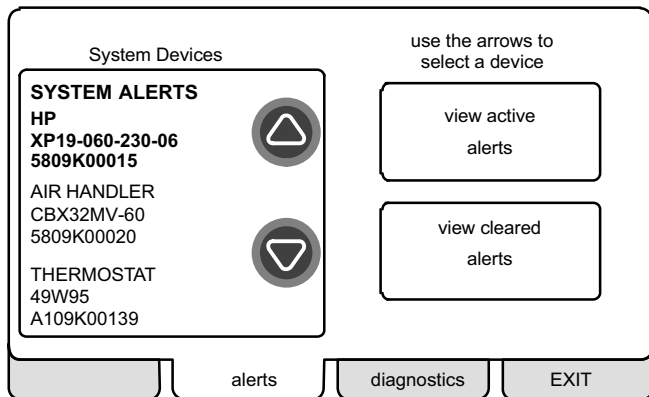


Figure 26. System Devices alerts

The first alert will be displayed in the "Device alert" screen (figure 27), in order of:

1. critical first (red icon),
2. service next (yellow icon).

If the information in the alert box exceeds the box size, press **press for more** to see the remaining information.

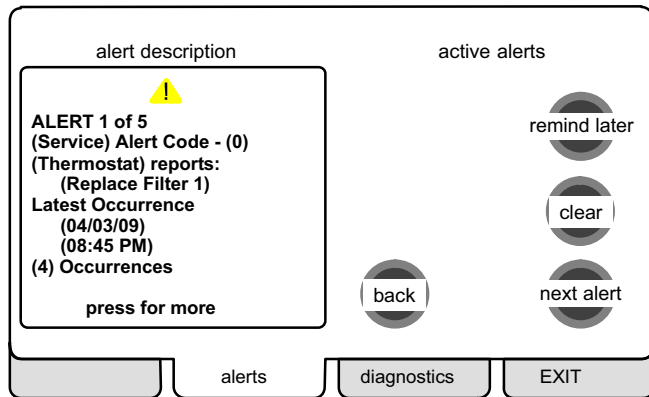


Figure 27. Device alert

## Clearing alerts

A **critical alert** (red icon) identifies a system or device issue that can prevent the system from working properly or at all, and if allowed to run, could cause damage to the system. The issue raised by the alert must be addressed before clearing the alert.

Press **clear** (see figure 27) to request clearing of a critical alert; then **confirm** the request (shown to the right). The device will respond to the request indicating whether or not the alert can be cleared at that time. If it cannot be cleared, revisit the alert issue and make repairs accordingly.

press 'confirm' to clear the alert, or press 'cancel'

**confirm** **cancel**

The **edit date** option is not available for a critical alert.

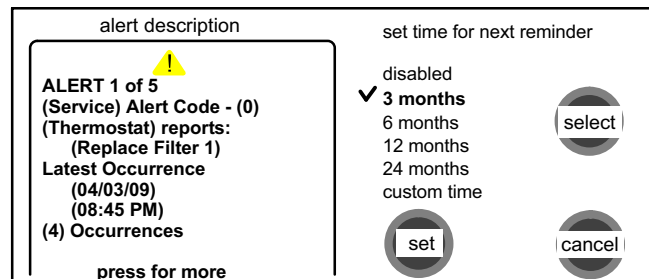
A **service alert** (yellow icon) reminds users to service filters, humidifier pad, UV light and PureAir™ Air Purification system.

Press **clear** (see figure 27) to request clearing of a service alert. If you answer **no** to the "was action taken" screen (shown to the right), the alert reappears and is not cleared. Action must be taken, either to perform the maintenance required, or instead of clearing, you may edit the time to again be reminded (described later).

was action taken?

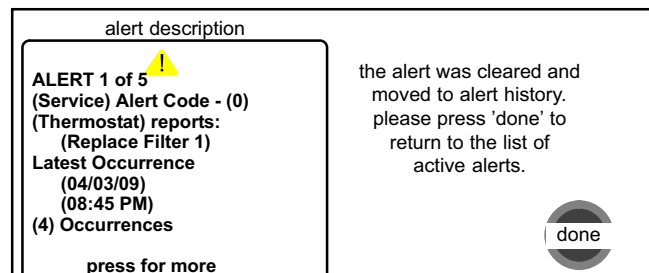
**yes** **no**

If you press **yes** to 'was action taken?', the "Set new alert date" screen (figure 28) appears. You may choose from the list of options or set a custom time (see figure 30).



**Figure 28. Set new alert date**

After selecting a time period using either method and pressing **set**, the "Cleared alert confirmation" screen (figure 29) appears.



**Figure 29. Cleared alert confirmation**

Press **done** to return to the device alert screen (figure 27, page 18).

### Using “custom time”

Use “Setting custom time” screen (figure 30) to set an exact date and time for the reminder to appear. Press in one of the boxes to highlight it and use the up/down arrows to change the value in that box. Repeat for all boxes. When desired reminder is displayed, press **set**.

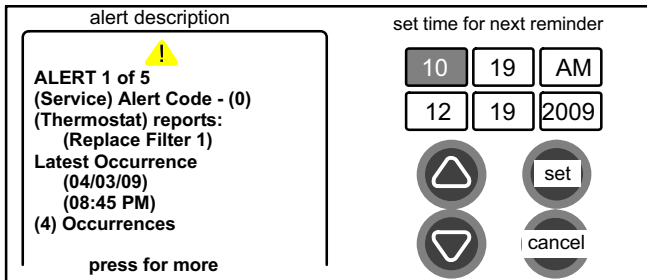


Figure 30. Setting custom time

### Using “remind later”

You may chose **remind later** and select from “Remind later options” list (see figure 31) or set a custom time as described earlier (see figure 30).

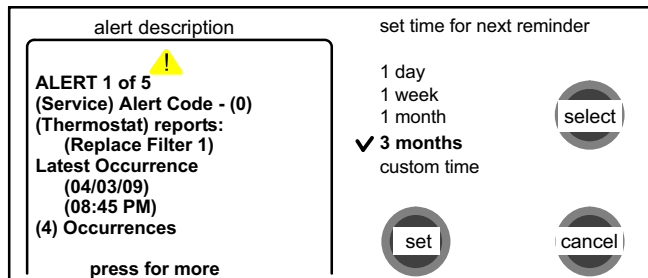


Figure 31. Remind later options

After selecting a reminder time using the listed options or a custom time, press **set**; the “Remind later confirmation” screen appears (see figure 32).

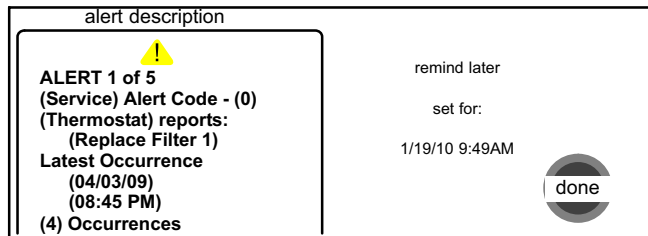


Figure 32. Remind later confirmation

Press **done** to return to the device alert screen (figure 27, page 18).

### View cleared alerts

A history of cleared alerts allows the installer to review the cleared alerts. This information can help diagnose problems. Use the arrows to (figure 34) **select** either SYSTEM ALERTS or a device from the list (see figure 34) and press **view cleared alerts**. Then scroll through the alerts using **next alert** (see figure 34). The **back** button returns to the system devices alerts screen.

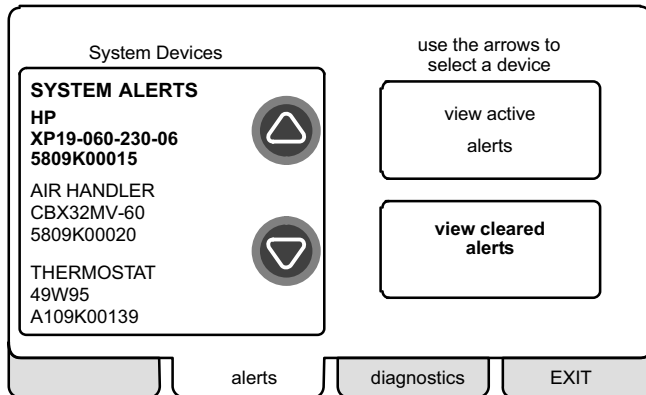


Figure 33. System Devices alerts

If no alert or only one alert is present in the history of cleared alerts, only the **back** button appears. If no alerts are present in the system or device's history, a message will state that "There are no new alerts that require service".

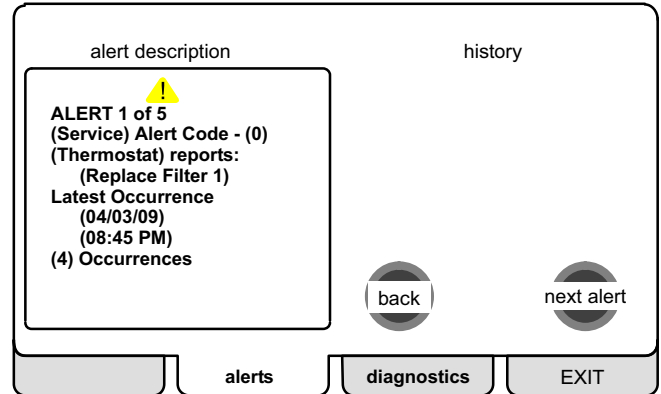


Figure 34. History display

## Access installer program from Home screen - Page 1 of 1

To access the installer program after the unit has been placed in operation and the user home screen is displayed, press the “Lennox” logo and hold for 5 seconds (see figure 35). The system will access the installer screens.

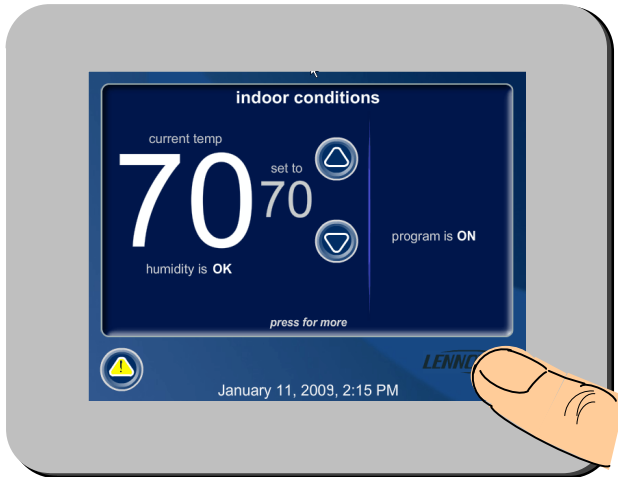


Figure 35. Enter installation setup mode from home screen

Figure 36, “Qualified Lennox equipment installer warning” screen appears; press **yes** to proceed (**no** returns the home screen).

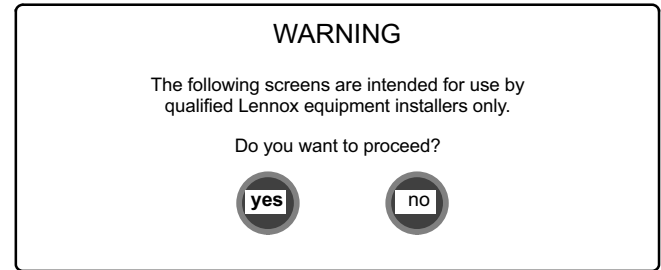


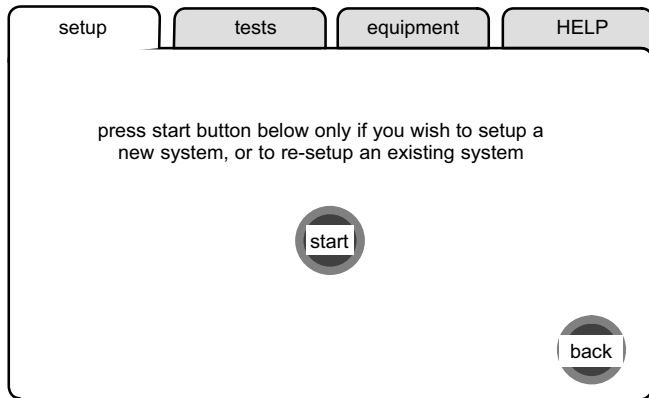
Figure 36. Qualified Lennox equipment installer warning

When you press **yes**, the thermostat's processor will search for communicating devices in the system. The next display will be a summary of all alerts detected.

After initial installation, if an alert is present when you are making changes to settings, no action on the alert is mandatory.

To begin reconfiguring a system, press the **setup** tab.

The "Start system configuration" screen (figure 37) appears; press **start** to proceed.

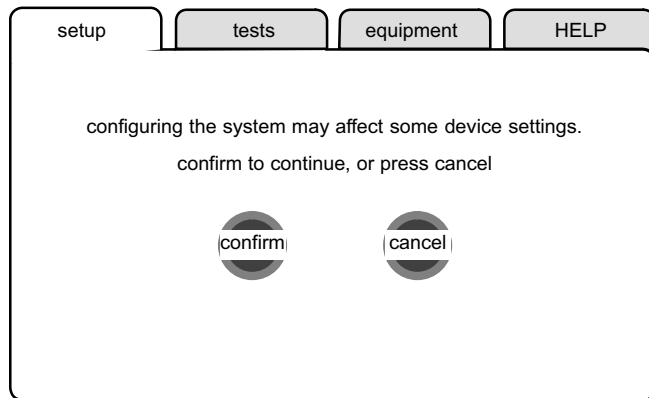


**Figure 37. Start system configuration**

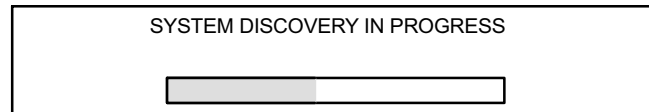
If this is the first attempt to configure a system, the screen will change to the system discovery screen.

The "Re-configure confirmation" screen (figure 38) will only appear on attempts to **RE-CONFIGURE** the system. It is a reminder that *system configuration* may affect some existing device settings and prompts to **confirm** or **cancel** the configuration process (returns to figure 37).

Press **confirm** to continue system configuration; the screen will change to the system discovery screen.



**Figure 38. Re-configure confirmation**

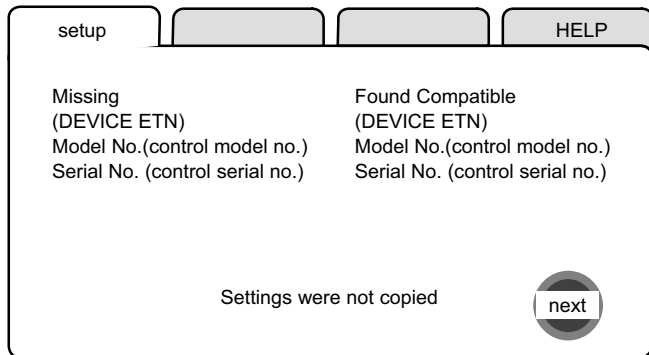


**Figure 39. System discovery**

## Reconfiguring a system - Page 2 of 2

While **reconfiguring**, the thermostat will have retained settings from the previous configuration. If a device has been replaced and re-configuration has detected its replacement device, it will know the original device is missing and prompt the installer (figure 40).

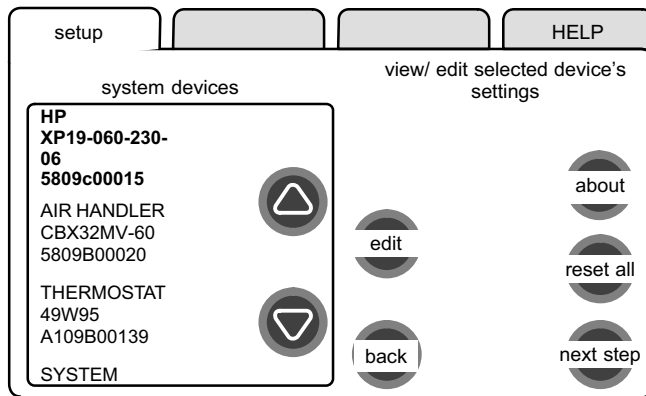
If this is the initial configuration, the “Compatible device found” screen does not appear.



**Figure 40. Compatible device found**

Press **next** to accept the device and write the thermostat's settings from the previous configuration to the found compatible device. The display changes to “Settings were copied”. Press **next** to advance to the next screen.

Figure 41 lists all communicating devices found and gives you an opportunity to review the reconfigured devices. Use the arrow buttons to scroll through the list of items found on the left of the screen. Press **about** to highlight an option on the right side of the screen and view details about that device. If necessary, change SYSTEM settings as described on Page 10.



**Figure 41. System devices screen**

Press **next step** to continue to test the system (see Page 14).

## Editable Parameters Table (User and Installer)

Parameter Name:	Default	Parameter Value Setting	Increment
<b>Installer settings</b>			
Time and Date	—	(Time/date elements screen)	—
Daylight Saving Time	Enabled	Enabled, Disabled	—
Circulate Fan - Percentage of Time ON	35%	15 to 45%	1%
Dealer Contact Information – Name	Lennox	(Typewriter input screen)	—
Dealer Contact Information – Address	—	(Typewriter input screen)	—
Dealer Contact Information – Phone	1-800-9-LENNOX	(Typewriter input screen)	—
Dealer Contact Information – Email	—	(Typewriter input screen)	—
Dealer Contact Information – Website	www.lennox.com	(Typewriter input screen)	—
<b>SYSTEM</b>			
Equipment Name	—	(Typewriter input screen)	—
Filter 1 Timer Selection	Calendar Time	Calendar Time, Run Time	—
Filter 2 Timer Selection	Calendar Time	Calendar Time, Run Time	—
Humidifier Pad Timer Selection	Calendar Time	Calendar Time, Run Time	—
UV Bulb Timer Selection	Calendar Time	Calendar Time, Run Time	—
PureAir Timer Selection	Calendar Time	Calendar Time, Run Time	—
Smooth Setback Recovery	Disabled	Enabled, Disabled	—
Electric Heat Control Mode	Standard	Standard, Even Heat	—
Gas Heat Control Mode	Modulating	Staged, Modulating	—
Autochangeover Temp Deadband	5°F	3 to 9°F	1°F
Max Heat Setpoint	90°F	40 to 90°F	1°F
Min Cool Setpoint	60°F	60 to 99°F	1°F
Heat/Cool Stages Locked In	Disabled	Enabled, Disabled	—

*table continued on next page*

Parameter Name:	Default	Parameter Value Setting	Increment
1st Stage Differential	0.5°F	0.5 to 3°F	.5°F
2nd Stage Differential	1.5°F	0.5 to 8°F	.5°F
3rd Stage Differential	2.0°F	0.5 to 8°F	.5°F
4th Stage Differential	2.5°F	0.5 to 8°F	.5°F
5th Stage Differential	3.0°F	0.5 to 8°F	.5°F
6th Stage Differential	3.5°F	0.5 to 8°F	.5°F
Stage Delay Timers	Enabled	Enabled, Disabled	—
2nd Stage Delay	20 Minutes	5 to 120 Minutes	5 Min
3rd Stage Delay	20 Minutes	5 to 120 Minutes	5 Min
4th Stage Delay	20 Minutes	5 to 120 Minutes	5 Min
5th Stage Delay	20 Minutes	5 to 120 Minutes	5 Min
6th Stage Delay	20 Minutes	5 to 120 Minutes	5 Min
Locked in 2nd Stage HP by Outdoor Temp	Off	Off, 40F (4C), 45F (7C), 50F (10C), 55F (13C),	—
Balance Point Control	Disabled	Enabled, Disabled	—
Defrost Target Discharge Temp	55°F	50 to 60°F	1°F
Dehumidification Control Mode	Display Only	Display Only, Basic, Precision	—
Humidification Control Mode	Display Only	Display Only, Basic, Precision, Dew Point Control	—
Autochangeover Humidification Deadband	5%	5 to 10%	1°F
Max Humidification Setpoint	45%	15 to 45%	1°F
Max Dehumidification Setpoint	40%	40 to 60%	1°F
OK/Humid Boundary	50%	45 to 60%	1°F

*table continued on next page*

Parameter Name:	Default	Parameter Value Setting	Increment
<b>AIR HANDLER</b>			
Equipment Name	Air Handler	(Typewriter input screen)	—
Electric Heating Airflow	nnnn CFM SEE NOTE -.	NOTE: CFM Default and Values Settings are dependent on the tonnage of the unit	5CFM
Low Cooling Airflow			5CFM
High Cooling Airflow			5CFM
Cooling Airflow Profile	1	1: No Delays, 3: ON: 82%/7.5min; OFF: No delays 2: ON: No delays; OFF: 45 sec delay 4: ON: 50%/30s,82%/7.5min; OFF:50%/30s	—
Low Heating Airflow	nnnn CFM SEE NOTE -.	NOTE: CFM Default and Values Settings are dependent on the tonnage of the unit	5CFM
High Heating Airflow			5CFM
Continuous Indoor Blower Airflow			10CFM
Humidification Airflow			10CFM
Dehumidification Airflow	70%	60 to 80% (percentage of reduction of High Cooling Airflow)	1%
Heating Indoor Blower OFF Delay	10 sec	0 to 10 Seconds	1 sec
Heating Indoor Blower ON Delay	0 sec	0 to 5 Seconds	1 sec
Cooling Indoor Blower OFF Delay	0 sec	0 to 30 Seconds	2 sec
Cooling Indoor Blower ON Delay	2 sec	0 to 10 Seconds	1 sec
HP Indoor Blower OFF Delay	45 sec	0 to 60 Seconds	5 sec
HP Indoor Blower ON Delay	0 sec	0 to 30 Seconds	5 sec
<b>THERMOSTAT</b>			
Equipment Name	—	(Typewriter input screen)	—
Temp Reading Calibration	0°F	-5°F to 5°F	1°F
Humidity Reading Calibration	0%	-10 to 10%	1%RH
<b>OUTDOOR EQUIPMENT</b>			
Equipment Name (HP and AC)	Outdoor Unit	(Typewriter input screen = up to 35 characters in string)	—
Compressor Short Cycle Delay (HP and AC)	300 Seconds	60 to 300 Seconds	60 Sec
Compressor Shift Delay On/Off (HP only)	On	On, Off	—
Defrost Termination Temp (HP only)	50°F	50 to 100°F	10°F

Parameter Name	Value				Dependency	Note
	Default	Min.	Max.	Incr.		
<b>FURNACE</b>						
Heating indoor blower OFF delay	DIP SW	60	180	10	None	DIP switch setting in Non-comm.
Heating indoor blower ON delay	45	15	45	5	None	45 sec fixed in Non-Comm. IFC
Cooling indoor blower OFF delay	0	0	30	2	Outdoor Unit present	Not used on Non Com. IFC
Cooling indoor Blower ON Delay	2	0	10	1	Outdoor Unit present	2 sec fixed in Non-Comm. IFC
Heat pump indoor blower OFF delay	45	0	60	5	Heat Pump present	Not used on Non Com. IFC
Heat pump indoor blower ON delay	0	0	30	5	Heat Pump present	Not used on Non Com. IFC
<b>Gas Heat Airflow Setting</b>						
Heating Airflow Control Type	0 – Fixed CFM	0	1	1	DATS installed	0 – Text ID 0x000E (Fixed CFM) 1 – Text ID 0x000F (Fixed DAT)
Low Heating Airflow (CFM @ 40% heat)	DIP SW	325	450	25	Heating Airflow Control Type = 0	70,000 BTU; 1/2 HP fan
		500	675	25		90,000 BTU; 1/2 HP fan
		425	625	25		90,000 BTU; 1HP fan
		625	875	25		110,000 BTU; 1 HP fan
		750	1025	25		135,000 BTU; 1HP fan
High Heating Airflow (CFM @ 100% heat)	DIP SW	800	1100	25	Heating Airflow Control Type = 0	70,000 BTU; 1/2 HP fan
		925	1250	25		90,000 BTU; 1/2 HP fan
		1025	1425	25		90,000 BTU; 1HP fan
		1350	1850	25		110,000 BTU; 1 HP fan
		1500	2050	25		135,000 BTU; 1HP fan
Low Heating Discharge Air Temperature (DAT @ 40% heat)	DIP SW*	110	140	5	Heating Airflow Control Type = 1	70,000 BTU; 1/2 HP fan
		110	140	5		90,000 BTU; 1/2 HP fan
		110	140	5		90,000 BTU; 1HP fan
		110	140	5		110,000 BTU; 1 HP fan
		110	140	5		135,000 BTU; 1HP fan
High Heating Discharge Air Temperature (DAT @ 100% heat)	DIP SW*	120	150	5	Heating Airflow Control Type = 1	70,000 BTU; 1/2 HP fan
		130	160	5		90,000 BTU; 1/2 HP fan
		120	150	5		90,000 BTU; 1HP fan
		120	150	5		110,000 BTU; 1 HP fan
		125	155	5		135,000 BTU; 1HP fan
* - Default DAT value is rounded to the closest number on 5 deg F resolution and limited by Minimum and Maximum value.						

table continued on next page

Parameter Name	Value				Dependency	Note
	Default	Min.	Max.	Incr.		
<b>Cooling Airflow Setting</b>						
High Cooling Airflow (CFM @ 100% cool)	OU tons (OUNC) * 400CFM	Min CFM	Max CFM	25	Outdoor Unit present	1/2 HP blower
		Min CFM	Max CFM	25		1 HP blower
Low Cooling Airflow (CFM @ lowest cool stage)	See <b>Note1</b> below	Min CFM	Max CFM	25	2+ stage Outdoor Unit present	1/2 HP blower
		Min CFM	Max CFM	25		1 HP blower
Airflow Profile - Cooling	DIP SW	0	3	1	Outdoor Unit present	0-Text ID 0x0105 (A:ON:50%/30s,82%/7.5min OFF:50%/30s) 1-Text ID 0x0106 (B:ON:82%/7.5min; OFF: No delays) 2-Text ID 0x0107 (C:ON: No delays; OFF: 45sec delay) 3-Text ID 0x0108 (D:No delays)
<b>Heat Pump Airflow Setting</b>						
High Heat Pump Airflow (CFM @ 100%)	OU tons (OUNC) * 400CFM	Min CFM	Max CFM	25	Heat Pump present	1/2 HP blower
		Min CFM	Max CFM	25		1 HP blower
Low Heat Pump Airflow (CFM @ lowest stage)	See <b>Note 2</b> below	Min CFM	Max CFM	25	2+ stage Heat Pump present	1/2 HP blower
		Min CFM	Max CFM	25		1 HP blower
<b>Other Parameters</b>						
Equipment Name	Furnace	N/A	N/A	N/A	None	Up to 35 characters
Continuous Indoor Blower Airflow	DIP SW (See <b>Note 3</b> )	Min CFM	Max CFM	25	None	1/2 HP blower
		Min CFM	Max CFM	25		1 HP blower
Humidification Airflow	Same as above	Min CFM	Max CFM	25	Humidifier present	1/2 HP blower
		Min CFM	Max CFM	25		1 HP blower
Dehumidification Airflow Percentage	140 (=70%)	120 (=60%)	160 (=80%)	2 (=1%)	OU present AND SC algorithm support	Percent of High Cooling Airflow
Note 1: Minimum Outdoor Unit Cooling Stage as a percentage of High Cooling Airflow (value is rounded up to the closest number on 25 CFM resolution)						
Note 2: Minimum Outdoor Unit Heating Stage as a percentage of High Heat Pump Airflow (value is rounded up to the closest number on 25 CFM resolution).						
Note 3: All communicating Installer Parameters default CFM values based on DIP switch setting (non-communicating value) are calculated using the CFM conversion tables and rounded up to closest number on 25 CFM resolution.						
Note 4: Parameter dependency - Certain parameters are dependent on others and may not be shown on the display.						
Note 5: Default Values - Jumper/DIP switches impact the default value of some parameters.						

Parameter Name:	Default	Parameter Value Setting	Increment
<b>User settings</b>			
Time and Date	—	(Time/date elements screen)	—
Daylight Saving Time	Enabled	Enabled, Disabled	—
Circulate Fan - Percentage of Time ON	35%	15 to 45%	1%
Dealer Contact Information – Name	Lennox	(Typewriter input screen)	—
Dealer Contact Information – Address	—	(Typewriter input screen)	—
Dealer Contact Information – Phone	1-800-9-LENNOX	(Typewriter input screen)	—
Dealer Contact Information – Email	—	(Typewriter input screen)	—
Dealer Contact Information – Website	www.lennox.com	(Typewriter input screen)	—
Language Displayed	English	English	—
Temperature Display Scale	(F)	(F) Fahrenheit, (C) Celsius	—
Clock Format	12H	12 Hour, 24 Hour	—
Screen Lock-out	Unlocked	Unlocked, Partially Locked, Fully Locked	—
Backlight Setting	Always On	Power Save, Always On	—
Backlight Intensity	100%	20 to 100%	20%
Outdoor Temp Display	Disabled	Disabled, Enabled	—
Indoor Humidity Display	Enabled	Disabled, Enabled	—
Filter 1 Timer	Disabled	Disabled, 3 Months, 6 Months, 12 Months, 24 Months, Custom Time	—
Filter 2 Timer	Disabled	Disabled, 3 Months, 6 Months, 12 Months, 24 Months, Custom Time	—
Humidifier Pad Timer	Disabled	Disabled, 3 Months, 6 Months, 12 Months, 24 Months, Custom Time	—
UV Bulb Timer	Disabled	Disabled, 3 Months, 6 Months, 12 Months, 24 Months, Custom Time	—
Maintenance Timer	Disabled	Disabled, 3 Months, 6 Months, 12 Months, 24 Months, Custom Time	—
PureAir Timer	Disabled	Disabled, 3 Months, 6 Months, 12 Months, 24 Months, Custom Time	—

## Alarm Codes and Troubleshooting

Alarm ID	Message Name	Action required to Clear/Recover
10	Unknown Device Detected - DEVICE2	Reconfigure the system. Press and hold Lennox Logo, press setup tab, press start, and press confirm. If still persists, then check all DEVICE connections to make sure they are icomfort compatible.
11	Missing DEVICE2	Check all connections and cycle system power. If problem persists, then reconfigure the system (procedure mentioned above).
12	Incomplete System	Thermostat did not find an Indoor Unit. Check connections and cycle power. Replace board if no response.
14	Too Many Devices of the Same Type	Thermostat found more than one outdoor unit, or more than 1 indoor unit, or more than 1 thermostat connected to the system. Check wiring and remove duplicate equipment.
18	Low Ambient HP Heat Lockout	Notification only - Outdoor Temp is below the Low Balance Point. HP will not be used to service a Heating Call.
19	High Ambient Auxiliary Heat Lockout	Notification only - Outdoor Temp is above the High Balance Point. Indoor Unit (Furnace or Electric Heat) will not be used to service a Heating Call.
29	Over Temperature Protection	Indoor Temp went above 99°F during a heating or cooling call. Heating is not allowed. Check that Thermostat Sensor is accurate. Check that Heating Equipment is not stuck ON (reversing value, etc.). Select system mode to cooling to try and cool the indoor space.
30	Low Temperature Protection	Indoor Temp went below 40°F. Cooling is not allowed. Check that cooling equipment is not stuck ON. Check accuracy of the thermostat temperature. Try to heat the space to above 40°F.
31	Lost Communication with DEVICE2	DEVICE2 is not communicating to the thermostat for more than 3 minutes. Check connections if fault persists, then cycle power.
32	Asynchronous Reset DEVICE2	DEVICE2 is resetting by itself. Check power connections, and check 24VAC voltage at DEVICE. The alarm is only cleared by pressing the clear button on the Installer Alerts Tab. If fault persists after checking connections, replace board.
34	Must Program Unit Capacity for DEVICE2	DEVICE2 is missing the programmed unit capacity. Go to DEVICE2 and program unit capacity manually. See unit IOM for instructions.
35	Incorrect Operation of DEVICE2	DEVICE2 did not follow the command of the thermostat. Check connections and cycle power.
105	Communication Problem	Equipment is unable to communicate. Check for miswired and/or loose connections and check for a high voltage source of noise close to the system (welder etc.).
110	Low AC Line Voltage	Line Voltage Low (Voltage lower than nameplate rating). Check voltage.
113	High AC Line Voltage	Line Voltage High (Voltage higher than nameplate rating). Check voltage.
114	AC Line Frequency/Distortion Problem	No 60 Hertz Power (Check voltage and frequency).
115	Low Secondary (24VAC) Voltage	24 Voltage Low (Range is 18 and 30 volts ). Check voltage.
116	High Secondary (24VAC) Voltage	24 Voltage High (Range is 18 and 30 volts ). Check voltage.
120	Unresponsive DEVICE2	Usually caused by delay in outdoor unit responding to indoor unit. Poling recycle power, check wiring.
124	Active Subnet Controller Missing	Equipment lost communication with the thermostat. Check connections and cycle power on the thermostat.

*table continued on next page*

## Alarm Codes and Troubleshooting

Alarm ID	Message Name	Action required to Clear/Recover
125	Control Hardware Problem	Hardware problem on the control board. Cycle power on control. Replace if problem prevents service and is persistent.
126	Control Internal Communication Problem	Hardware problem on the control board. Cycle power on control. Replace if problem prevents service and is persistent.
130	Configuration Jumper Missing	Configuration jumper(s) missing on control board (applicable in non-communication only).
131	Corrupted Control Parameters	Reconfigure the system. Replace board if service (heating cooling) is not viable.
132	Failed Flash CRC Check (Check Sum) Software is corrupted.	Recycle power, if re-occurs replace control.
180	Outdoor Temperature Sensor Problem	Compare outdoor sensor resistance to temperature/resistance charts in installation instructions. Replace if necessary.
200	Rollout Limit Switch Open	Correct unit cause of rollout trip or replace flame rollout switch and test furnace operation.
201	Indoor Blower Motor Problem	Indoor blower communication failure including power outage. Check wiring to motor.
202	ID Blower Motor & Unit Size Mismatch	Incorrect appliance capacity code selected. Check for proper configuring under: <i>Unit Size Codes for Furnace/Air Handler</i> on configuration guide or in installation instructions.
203	Invalid Unit Code	No appliance capacity code selected. Check for proper configuring under: <i>Unit Size Codes for Furnace/Air Handler</i> on configuration guide or in installation instructions.
204	Gas Valve Problem	Check operation and wiring of gas valve.
205	Gas Valve Relay Contact Closed	Check wiring to relay; if wiring is correct, replace relay.
207	HSI Sensed Open	Measure resistance of Hot Surface Ignition ignitor. Replace if open or not within specification range found in IOM.
223	Low Pressure Switch Open	Check inches of water column closing pressure of low pressure switch on heat call, measure inches of water column of operating pressure, inspect vent and combustion air inducer for correct operation and restriction.
224	Low Pressure Switch Stuck Closed	Check operation of low pressure switch for stuck closed on heat call, measure inches of water column of operating pressure, inspect vent and combustion air inducer for correct operation and restriction.
225	High Pressure Switch Failed to Close	Check inches of water column closing pressure of high pressure switch on heat call, measure inches of water column of operating pressure, inspect vent and combustion air inducer for correct operation and restriction.
226	High Pressure Switch Stuck Closed	Check operation of high pressure switch for closing on heat call, measure inches of water column of operating pressure, inspect vent and combustion air inducer for correct operation and restriction.
227	Low Pressure Switch Open in Run Mode	Check inches of water column closing pressure of low pressure switch on heat call, measure inches of water column of operating pressure, inspect vent and combustion air inducer for correct operation and restriction.
228	Inducer/Pressure Switch Calibration Failure	Unable to perform pressure switch calibration. Check vent system and pressure switch wiring connections.
240	Low Flame Current - Run Mode	Check micro amperes of flame sensor in board diagnostics or field installed mode; clean or replace sensor. Measure voltage of neutral to ground for good unit ground.

*table continued on next page*

## Alarm Codes and Troubleshooting

Alarm ID	Message Name	Action required to Clear/Recover
241	Flame Out of Sequence - Still Present	Shut off gas, check for gas valve leak.
250	Primary Limit Switch Open	Check firing rate on furnace, blockage in heater, and air flow.
252	Discharge Air Temperature High	Check temperature rise, air flow and input rate.
270	Watch Guard - Flame Failure on Ignite	Check for gas flow, ignitor lighting burner, flame sensor current.
271	Watch Guard - Low Pressure Switch Open	Check inches of water column closing pressure of low pressure switch on heat call, measure inches of water column of operating pressure, inspect vent and combustion air inducer for correct operation and restriction.
272	Watch Guard - Low Pressure Switch Open Run Mode	Check operation of low pressure switch for stuck closed on heat call, measure inches of water column of operating pressure, inspect vent and combustion air inducer for correct operation and restriction. Check inches of water column closing pressure of high pressure switch on heat call, measure inches of water column of operating pressure, inspect vent and combustion air inducer for correct operation and restriction.
273	Watch Guard - Flame Fail in Run Mode	Check micro amperes of flame sensor in board diagnostics or field installed mode; clean or replace sensor. Measure voltage of neutral to ground for good unit ground.
274	Watch Guard - Primary Limit Switch Open	Check why limit is tripping, over fired, low air flow.
275	Watch Guard - Flame Out of Sequence. No Flame	Shut off gas, check for gas valve leak.
276	Watch Guard - Calibration Failure	Unable to perform pressure switch calibration. Check vent system and pressure switch wiring connections.
290	Ignition Circuit Problem	Measure resistance of Hot Surface Ignition ignitor, replace if open or not within specification; otherwise replace control.
291	Heat Airflow Restricted Below Min.	Check for dirty filter, unit air flow restriction, blower performance.
292	Indoor Blower Motor Start Problem	Indoor blower motor unable to start (seized bearing, stuck wheel, etc.). Replace motor or wheel if assembly does not operate or meet performance.
294	Inducer Motor Over current	Check combustion blower bearings, wiring, amps. Replace if does not operate or meets performance.
295	Indoor Blower Over Temperature	Indoor blower motor over temperature (motor tripped on internal protector). Check motor bearings, amps; replace if necessary.
310	Discharge Air Sensor Problem	Compare outdoor sensor resistance to temperature/resistance charts in installation instructions. Replace sensor if necessary.
311	Heat Rate Reduced to Match Airflow	Furnace blower in cutback mode due to restricted airflow. Check filter and ductwork. To clear, replace filter if needed or repair/add ductwork.
312	Reduced Airflow - Indoor Blower Cutback	Restricted airflow - Indoor blower is running at a reduced CFM (Cutback Mode - The variable speed motor has pre-set speed and torque limiters to protect the motor from damage caused by operating out of its designed parameters (0 to 0.8" w.g. total external static pressure). Check filter and ductwork. To clear, replace filter if needed or repair/add ductwork.

*table continued on next page*

## Alarm Codes and Troubleshooting

Alarm ID	Message Name	Action required to Clear/Recover
313	Indoor/Outdoor Unit Capacity Mismatch	Incorrect indoor/outdoor capacity code selected. Check for proper configuring in installation instructions. Alarm is just a warning. The system will operate, but might not meet efficiency and capacity parameters and alarm would clear when commissioning is exited.
345	Relay O Failure	O relay / Stage 1 failed (Pilot relay contacts did not close or the relay coil did not energize),
346	HP Jumper not Removed	Configuration jumper(s) not removed on control board cut O-R. Applicable with non communicating outdoor unit with communicating indoor system.
347	Relay Y1 Failure	Y1 relay / Stage 1 failed (Pilot relay contacts did not close or the relay coil did not energize),
348	Relay Y2 Failure	Y2 relay / Stage 2 failed (Pilot relay contacts did not close or the relay coil did not energize),
349	IFC Error Check Jumper O to R	Configuration link R to O needs to be restored Applicable in non communicating mode,
350	Electric Heat not Configured	Heat call with no configured or mis-configured electric heat. Check for proper configuring under <i>Configuring Electric Heat Stages</i> in the air handler installation instructions.
351	Electric Heat Stage 1 Problem	Heat section / Stage 1 failed (Pilot relay contacts did not close or the relay coil in the electric heat section did not energize).
352	Electric Heat Stage 2 Problem	Heat section / Stage 2 failed (Same as Code 351).
353	Electric Heat Stage 3 Problem	Heat section / Stage 3 failed (Same as Code 351).
354	Electric Heat Stage 4 Problem	Heat section / Stage 4 failed (Same as Code 351).
355	Electric Heat Stage 5 Problem	Heat section / Stage 5 failed (Same as Code 351).
400	LSOM Compressor Internal Overload Tripped	Compressor protector is open. Check for high head pressure, check compressor supply voltage. Outdoor unit power disconnect is open. Compressor circuit breaker or fuse(s) is open. Broken wire or connector is not making contact. Low or high pressure switch open if present in the system. Compressor contactor has failed to close.
401	LSOM Compressor Long Run Cycle	Compressor ran over 18 hours on one room thermostat demand.
402	LSOM Outdoor Unit System Pressure Trip	Outdoor unit pressure trip. Check dirty coil, fan motor, refrigerant charge.
403	LSOM Compressor Short-Cycling	Compressor short cycling (Running less than 4 minutes).
404	LSOM Compressor Rotor Locked	Check capacitor, wiring, hard-start kit, replace compressor.
405	LSOM Compressor Open Circuit	Check compressor for hot (cool down), check pressures, fan motor etc. Replace compressor if unable to get circuit to close and compressor to operate.
406	LSOM Compressor Open Start Circuit	
407	LSOM Compressor Open Run Circuit	
408	LSOM Compressor Contactor Welded	Replace contactor.
409	LSOM Compressor Voltage Low	Check power to unit.

*table continued on next page*

## Alarm Codes and Troubleshooting

Alarm ID	Message Name	Action required to Clear/Recover
410	Open Low Pressure Switch	Remove any blockages or restrictions from indoor coils and/or fans. Check refrigerant charge and system operation.
411	Low Pressure Switch Strikes Lockout	Check system charge using approach and sub cooling temperatures. Reset by putting outdoor board in test mode or resetting low voltage power.
412	Open High Pressure Switch	Check system operating pressures and compare to unit charging charts.
413	High Pressure Switch Strikes Lockout	Check system charge using approach and sub cooling temperatures. Reset by putting outdoor board in test mode or resetting low voltage power.
414	High Discharge Line Temperature	Check system operating pressures and compare to unit charging charts.
415	High Discharge Line Temperature Strikes Lockout	Check system charge using approach and sub cooling temperatures. Reset by putting outdoor board in test mode or resetting low voltage power.
416	Outdoor Coil Sensor Faulty	Sensor being detected open or shorted or out of temperature range. Board will not perform demand or time/temperature defrost operation. (System will still heat or cool).
417	Discharge Sensor Faulty	The board detects open sensor or out of temperature sensor range. This fault is detected by allowing the unit to run for 90 seconds before checking sensor resistance. If the sensor resistances not within range after 90 seconds, the board will count one fault. After 5 faults, the board will lockout.
418	W Output Hardware Fault	Replace the control board.
419	W Output Hardware Fault Lockout	
420	Defrost Out of Control	Defrost longer than 20 minutes. Check HP operation.
421	W External Miswire Alarm	Check and correct the wiring.
530	Damper End Switch Failed to Close	Repair/replace damper.
531	Damper End Switch Failed to Open	Repair/replace damper.
532	Damper Control Module Alarm	Check/replace if needed.
594	Discharge Air Temperature Sensor Problem	Check wiring. Ohm out sensor and check to temperature/resistance chart.
700	Comfort Sensor Temperature Sensor Problem	Recalibrate stat to clear, replace thermostat if needed.
701	Comfort Sensor Temperature Too High	Recalibrate stat to clear, cool down stat, adjust setpoint, replace thermostat if needed.
702	Comfort Sensor Temperature Too Low	Recalibrate stat to clear, warm up stat, adjust setpoint, replace thermostat if needed.
703	Comfort Sensor Humidity Sensor Problem	Recalibrate stat to clear, adjust setpoint, replace thermostat if needed.
704	Comfort Sensor Humidity Too High	Recalibrate stat to clear, replace thermostat if needed.
705	Comfort Sensor Humidity Too Low	Recalibrate stat to clear replace thermostat if needed.

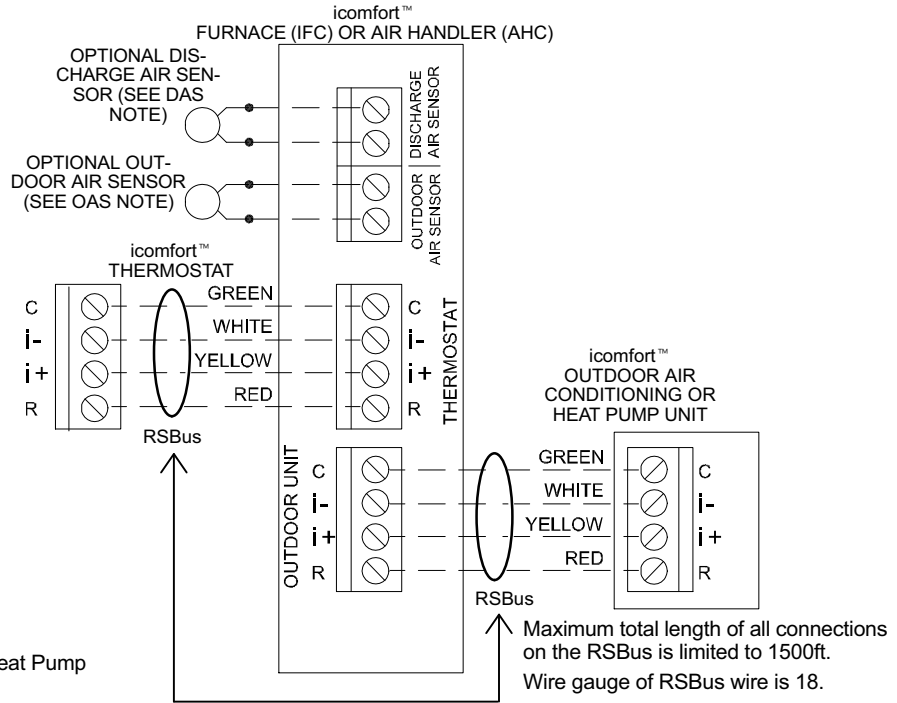
## Wiring Diagrams - Communicating Systems

**DAS NOTE** - The discharge air sensor is intended to be mounted downstream of the heat exchanger and air conditioning coil. It must be placed in free airflow, where other accessories (such as humidifiers, UV lights, etc.) will not interfere with its accuracy. Wiring distance between the IFC or AHC and the discharge air sensor should not exceed 10ft when wired with 18-gauge thermostat wire.

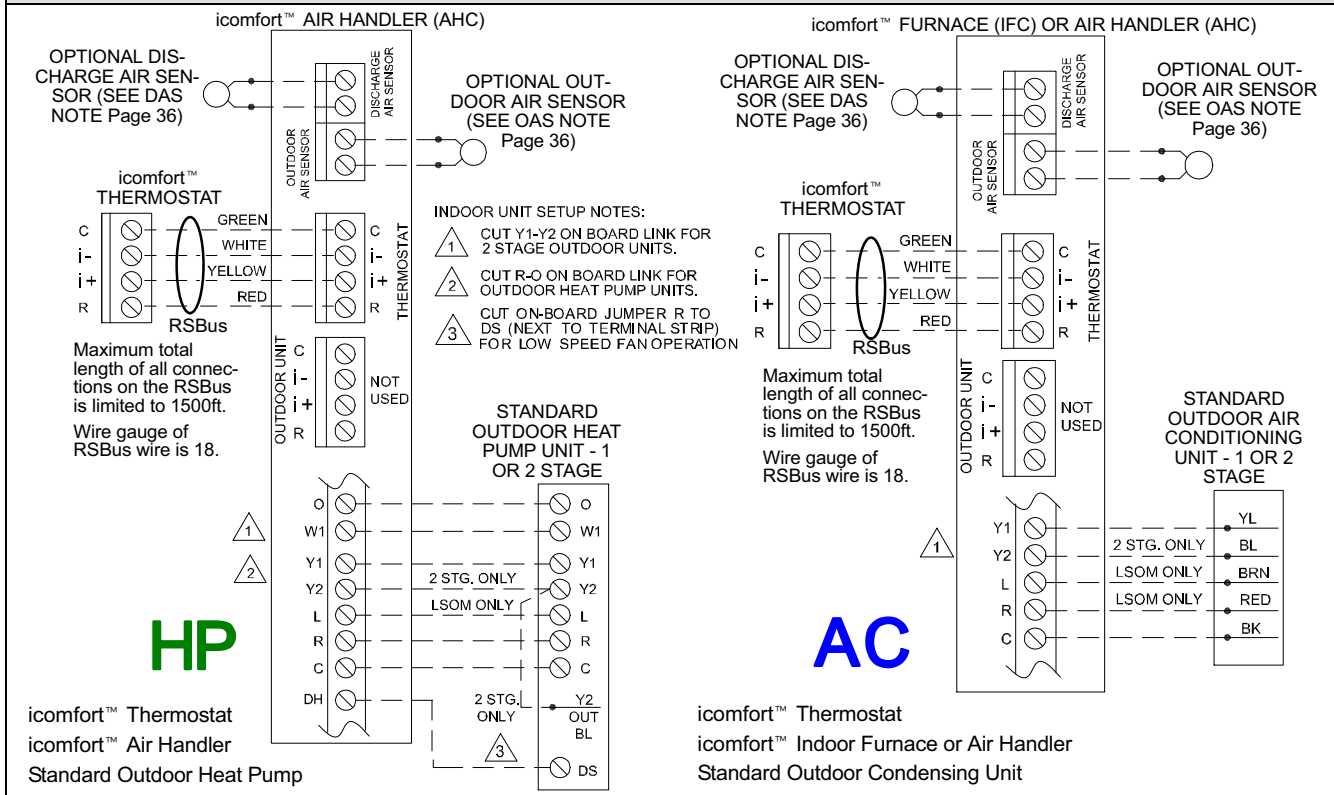
**OAS NOTE** - Wiring distance between the IFC or AHC and the outdoor temperature sensor should not exceed 200ft when wired with 18-gauge thermostat wire.

# HP/AC

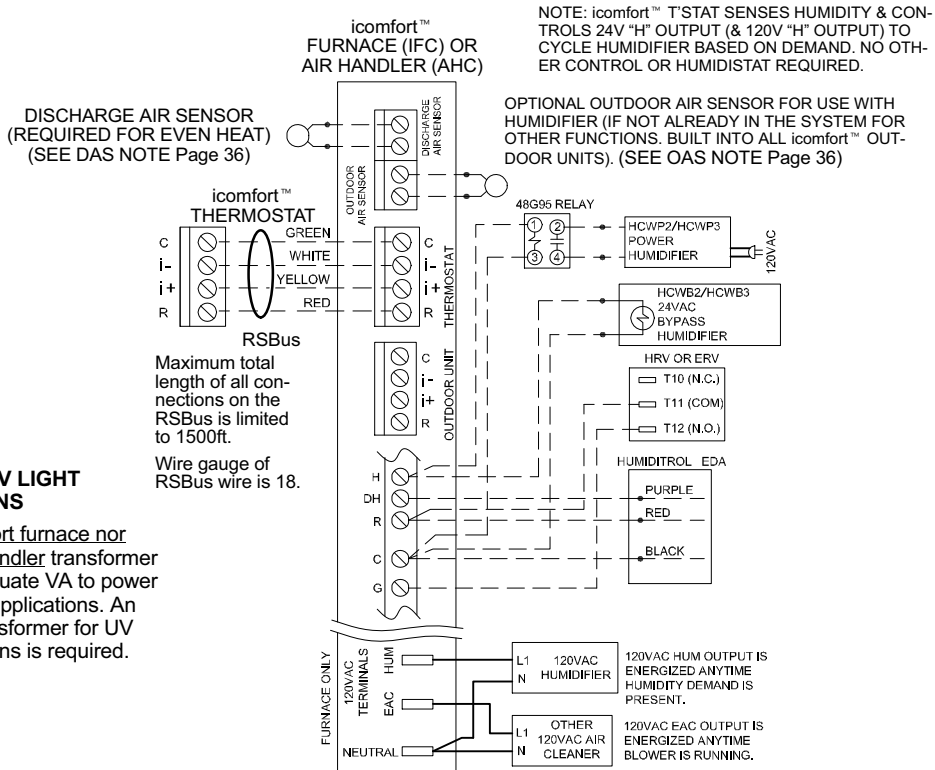
icomfort™ Thermostat  
 icomfort™ Indoor Furnace or Air Handler  
 icomfort™ Outdoor Condensing Unit or Heat Pump



# Wiring Diagrams - Communicating Indoor/non-Communicating Outdoor Systems



## Optional Accessories for use with any icomfort™ system

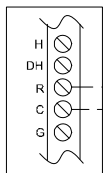


### NOTE: 24V UV LIGHT APPLICATIONS

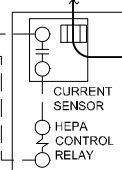
Neither icomfort furnace nor icomfort air handler transformer will have adequate VA to power 24V UV light applications. An additional transformer for UV light applications is required.

## Optional Accessories for use with any icomfort™ system

**icomfort™  
FURNACE OR  
AIR HANDLER**

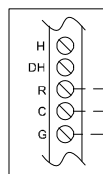


**HEPA BYPASS FIL-  
TER X2680 HEPA  
INTERLOCK KIT**

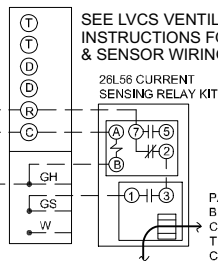


PASS INDOOR BLOWER MOTOR COMMON WIRE THROUGH CURRENT LOOP.  
SEE HEPA INTERLOCK KIT FOR INSTALLATION DETAILS

**icomfort™  
FURNACE OR  
AIR HANDLER**



**LVCS VENTILATION  
CONTROL SYSTEM**

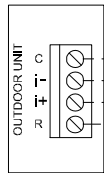


SEE LVCS VENTILATION INSTRUCTIONS FOR DAMPER & SENSOR WIRING

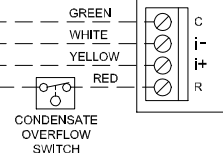
28L56 CURRENT SENSING RELAY KIT

PASS INDOOR BLOWER MOTOR COMMON WIRE THROUGH CURRENT LOOP.

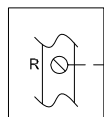
**icomfort™  
FURNACE OR  
AIR HANDLER**



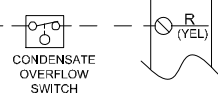
**icomfort™  
OUTDOOR AIR  
CONDITIONING OR  
HEAT PUMP UNIT**



**icomfort™  
FURNACE OR  
AIR HANDLER**



**STANDARD  
1 OR 2 STAGE  
AC OR HP UNIT**



OTHER OUTDOOR CONNECTIONS REMAIN THE SAME. REFER TO SPECIFIC DIAGRAM